

- **ADSL Differential Line Driver and Receiver**
- **Driver Features**
  - 140 MHz Bandwidth (–3dB) With 25-Ω Load
  - 315 MHz Bandwidth (–3dB) With 100-Ω Load
  - 1000 V/μs Slew Rate, G = 2
  - 400 mA Output Current Minimum Into 25-Ω Load
  - –72 dB 3rd Order Harmonic Distortion at f = 1 MHz, 25-Ω Load, and 20 V<sub>O(PP)</sub>
- **Receiver Features**
  - 330 MHz Bandwidth (–3dB)
  - 900 V/μs Slew Rate at G = 2
  - –76 dB 3rd Order Harmonic Distortion at f = 1 MHz, 150-Ω Load, and 20 V<sub>O(PP)</sub>
- **Wide Supply Range ±4.5 V to ±16 V**
- **Available in the PowerPAD™ Package**
- **Improved Replacement for AD816 or EL1501**
- **Evaluation Module Available**

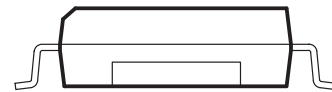
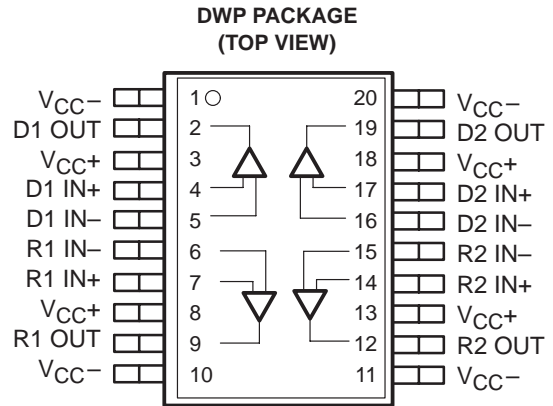

Cross Section View Showing PowerPAD

### description

The THS6002 contains two high-current, high-speed drivers and two high-speed receivers. These drivers and receivers can be configured differentially for driving and receiving signals over low-impedance lines. The THS6002 is ideally suited for asymmetrical digital subscriber line (ADSL) applications where it supports the high-peak voltage and current requirements of that application. Both the drivers and the receivers are current feedback amplifiers designed for the high slew rates necessary to support low total harmonic distortion (THD) in ADSL applications. Separate power supply connections for each driver are provided to minimize crosstalk.

HIGH-SPEED xDSL LINE DRIVER/RECEIVER FAMILY

| DEVICE  | DRIVER | RECEIVER | 5 V | ±5 V | ±15 V | BW (MHz) | SR (V/μs) | THD f = 1 MHz (dB) | I <sub>O</sub> (mA) | V <sub>n</sub> (nV/√Hz) |
|---------|--------|----------|-----|------|-------|----------|-----------|--------------------|---------------------|-------------------------|
| THS6002 | •      | •        |     | •    | •     | 140      | 1000      | –62                | 500                 | 1.7                     |
| THS6012 | •      |          |     | •    | •     | 140      | 1300      | –65                | 500                 | 1.7                     |
| THS6022 | •      |          |     | •    | •     | 210      | 1900      | –66                | 250                 | 1.7                     |
| THS6062 |        | •        | •   | •    | •     | 100      | 100       | –72                | 90                  | 1.6                     |
| THS7002 |        | •        |     | •    | •     | 70       | 100       | –84                | 25                  | 2.0                     |



**CAUTION:** The THS6002 provides ESD protection circuitry. However, permanent damage can still occur if this device is subjected to high-energy electrostatic discharges. Proper ESD precautions are recommended to avoid any performance degradation or loss of functionality.



Please be aware that an important notice concerning availability, standard warranty, and use in critical applications of Texas Instruments semiconductor products and disclaimers thereto appears at the end of this data sheet.

PowerPAD is a trademark of Texas Instruments Incorporated.

PRODUCTION DATA information is current as of publication date. Products conform to specifications per the terms of Texas Instruments standard warranty. Production processing does not necessarily include testing of all parameters.



# THS6002

## DUAL DIFFERENTIAL LINE DRIVERS AND RECEIVERS

SLOS202D– JANUARY 1998– REVISED JULY 1999

### description (continued)

The THS6002 is packaged in the patented PowerPAD package. This package provides outstanding thermal characteristics in a small footprint package, which is fully compatible with automated surface mount assembly procedures. The exposed thermal pad on the underside of the package is in direct contact with the die. By simply soldering the pad to the PWB copper and using other thermal outlets, the heat is conducted away from the junction.

#### AVAILABLE OPTIONS

| T <sub>A</sub> | PACKAGED DEVICE                       |                   |
|----------------|---------------------------------------|-------------------|
|                | PowerPAD PLASTIC SMALL OUTLINE† (DWP) | EVALUATION MODULE |
| 0°C to 70°C    | THS6002CDWP                           | THS6002EVM        |
| –40°C to 85°C  | THS6002IDWP                           |                   |

† The DWP packages are available taped and reeled. Add an R suffix to the device type (i.e., THS6002CDWPR)

### absolute maximum ratings over operating free-air temperature (unless otherwise noted)†

|   |                  |
|---|------------------|
| Supply voltage, V <sub>CC+</sub> to V <sub>CC–</sub>                                | 33 V             |
| Input voltage, V <sub>I</sub> (driver and receiver)                                 | ±V <sub>CC</sub> |
| Output current, I <sub>O</sub> (driver) (see Note 1)                                | 800 mA           |
| Output current, I <sub>O</sub> (receiver) (see Note 1)                              | 150 mA           |
| Differential input voltage, V <sub>ID</sub> (driver and receiver)                   | 6 V              |
| Continuous total power dissipation at (or below) T <sub>A</sub> = 25°C (see Note 1) | 5.8 W            |
| Operating free air temperature, T <sub>A</sub>                                      | –40°C to 85°C    |
| Storage temperature, T <sub>stg</sub>   | –65°C to 125°C   |
| Lead temperature, 1,6 mm (1/16 inch) from case for 10 seconds                       | 300°C            |

† Stresses beyond those listed under “absolute maximum ratings” may cause permanent damage to the device. These are stress ratings only, and functional operation of the device at these or any other conditions beyond those indicated under “recommended operating conditions” is not implied. Exposure to absolute-maximum-rated conditions for extended periods may affect device reliability.

NOTE 1: The THS6002 incorporates a PowerPad on the underside of the chip. This acts as a heatsink and must be connected to a thermal dissipation plane for proper power dissipation. Failure to do so can result in exceeding the maximum junction temperature, which could permanently damage the device. See the *Thermal Information* section of this document for more information about PowerPad technology.

### recommended operating conditions

|   |               | MIN  | TYP | MAX | UNIT |
|---|---------------|------|-----|-----|------|
| Supply voltage, V <sub>CC+</sub> and V <sub>CC–</sub> | Split supply  | ±4.5 |     | ±16 | V    |
|   | Single supply | 9    |     | 32  |      |
| Operating free-air temperature, T <sub>A</sub>        | C suffix      | 0    |     | 70  | °C   |
|   | I suffix      | –40  |     | 85  |      |



# THS6002 DUAL DIFFERENTIAL LINE DRIVERS AND RECEIVERS

SLOS202D—JANUARY 1998—REVISED JULY 1999

## functional block diagram

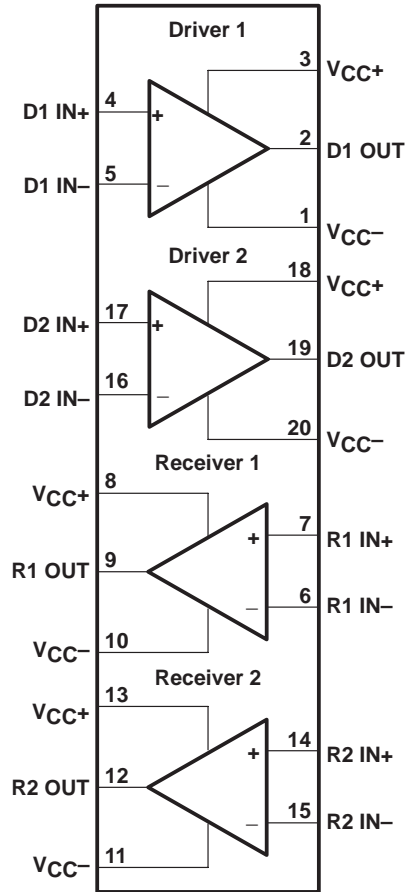

# THS6002

## DUAL DIFFERENTIAL LINE DRIVERS AND RECEIVERS

SLOS202D– JANUARY 1998– REVISED JULY 1999

### DRIVER

electrical characteristics,  $V_{CC} = \pm 15\text{ V}$ ,  $R_L = 25\ \Omega$ ,  $R_F = 1\text{ k}\Omega$ ,  $T_A = 25^\circ\text{C}$  (unless otherwise noted)

| PARAMETER |   | TEST CONDITION <sup>†</sup>                      |                           | MIN                        | TYP                 | MAX                 | UNIT                         |               |
|-----------|---|--|---------------------------|----------------------------|---------------------|---------------------|------------------------------|---------------|
| $V_{CC}$  | Power supply operating range              | Split supply                                     |                           | $\pm 4.5$                  |                     | $\pm 16.5$          | V                            |               |
|           |   | Single supply                                    |                           | 9                          |                     | 33                  |                              |               |
| $V_O$     | Output voltage swing                      | Single ended                                     | $R_L = 25\ \Omega$        | $V_{CC} = \pm 5\text{ V}$  | 3<br>to<br>-2.8     | 3.2<br>to<br>-3     | V                            |               |
|           |   |  |                           | $V_{CC} = \pm 15\text{ V}$ | 11.8<br>to<br>-11.5 | 12.5<br>to<br>-12.2 |                              |               |
|           |   | Differential                                     | $R_L = 50\ \Omega$        | $V_{CC} = \pm 5\text{ V}$  | 6<br>to<br>-5.6     | 6.4<br>to<br>-6     | V                            |               |
|           |   |  |                           | $V_{CC} = \pm 15\text{ V}$ | 23.6<br>to<br>-23   | 25<br>to<br>-24.4   |                              |               |
| $V_{ICR}$ | Common-mode input voltage range           | $V_{CC} = \pm 5\text{ V}$                        |                           | $\pm 3.6$                  |                     | $\pm 3.7$           | V                            |               |
|           |   | $V_{CC} = \pm 15\text{ V}$                       |                           | $\pm 13.4$                 |                     | $\pm 13.5$          |                              |               |
| $V_{IO}$  | Input offset voltage                      | $V_{CC} = \pm 5\text{ V}$ or $\pm 15\text{ V}$   | $T_A = 25^\circ\text{C}$  |                            | 2                   | 5                   | mV                           |               |
|           |   |  | $T_A = \text{full range}$ |                            |                     | 7                   |                              |               |
|           | Input offset voltage drift                | $V_{CC} = \pm 5\text{ V}$ or $\pm 15\text{ V}$ , | $T_A = \text{full range}$ |                            |                     | 20                  | $\mu\text{V}/^\circ\text{C}$ |               |
|           | Differential input offset voltage         | $V_{CC} = \pm 5\text{ V}$ or $\pm 15\text{ V}$   | $T_A = 25^\circ\text{C}$  |                            | 1.5                 | 4                   | mV                           |               |
|           |   |  | $T_A = \text{full range}$ |                            |                     | 5                   |                              |               |
|           | Differential input offset voltage drift   | $V_{CC} = \pm 5\text{ V}$ or $\pm 15\text{ V}$ , | $T_A = \text{full range}$ |                            |                     | 10                  | $\mu\text{V}/^\circ\text{C}$ |               |
| $I_{IB}$  | Input bias current                        | $V_{CC} = \pm 5\text{ V}$ or $\pm 15\text{ V}$   | Negative                  | $T_A = 25^\circ\text{C}$   |                     | 3                   | 9                            | $\mu\text{A}$ |
|           |   |  |                           | $T_A = \text{full range}$  |                     |                     | 12                           |               |
|           |   |  | Positive                  | $T_A = 25^\circ\text{C}$   |                     | 4                   | 10                           | $\mu\text{A}$ |
|           |   |  |                           | $T_A = \text{full range}$  |                     |                     | 12                           |               |
|           |   |  | Differential              | $T_A = 25^\circ\text{C}$   |                     | 1.5                 | 8                            | $\mu\text{A}$ |
|           |   |  |                           | $T_A = \text{full range}$  |                     |                     | 11                           |               |
| $I_O$     | Output current (see Note 2)               | $V_{CC} = \pm 5\text{ V}$ ,                      | $R_L = 5\ \Omega$         |                            | 500                 |                     | mA                           |               |
|           |   | $V_{CC} = \pm 15\text{ V}$ ,                     | $R_L = 25\ \Omega$        | 400                        | 500                 |                     |                              |               |
| $I_{OS}$  | Short-circuit output current (see Note 2) |  |                           |                            | 800                 |                     | mA                           |               |
|           | Open loop transresistance                 | $V_{CC} = \pm 5\text{ V}$                        |                           |                            | 1.5                 |                     | M $\Omega$                   |               |
|           |   | $V_{CC} = \pm 15\text{ V}$                       |                           |                            | 5                   |                     |                              |               |
| CMRR      | Common-mode rejection ratio               | $V_{CC} = \pm 5\text{ V}$ or $\pm 15\text{ V}$ , |                           | $T_A = \text{full range}$  | 62                  | 70                  | dB                           |               |
|           | Differential common-mode rejection ratio  |  |                           |                            |                     | 100                 |                              |               |
|           | Crosstalk                                 | Driver to driver                                 | $V_I = 200\text{ mV}$ ,   | $f = 1\text{ MHz}$         |                     | -62                 | dB                           |               |

<sup>†</sup> Full range is  $0^\circ\text{C}$  to  $70^\circ\text{C}$  for the THS6002C and  $-40^\circ\text{C}$  to  $85^\circ\text{C}$  for the THS6002I.

NOTE 2: A heat sink is required to keep the junction temperature below absolute maximum when an output is heavily loaded or shorted. See absolute maximum ratings and Thermal Information section.



# THS6002 DUAL DIFFERENTIAL LINE DRIVERS AND RECEIVERS

SLOS202D– JANUARY 1998– REVISED JULY 1999

## DRIVER

**electrical characteristics,  $V_{CC} = \pm 15\text{ V}$ ,  $R_L = 25\ \Omega$ ,  $R_F = 1\ \text{k}\Omega$ ,  $T_A = 25^\circ\text{C}$  (unless otherwise noted) (continued)**

| PARAMETER |                                | TEST CONDITIONS†           |                           | MIN | TYP  | MAX | UNIT       |
|-----------|--------------------------------|----------------------------|---------------------------|-----|------|-----|------------|
| PSRR      | Power supply rejection ratio   | $V_{CC} = \pm 5\text{ V}$  | $T_A = 25^\circ\text{C}$  | -68 | -74  |     | dB         |
|           |                                |                            | $T_A = \text{full range}$ | -65 |      |     |            |
|           |                                | $V_{CC} = \pm 15\text{ V}$ | $T_A = 25^\circ\text{C}$  | -64 | -72  |     | dB         |
|           |                                |                            | $T_A = \text{full range}$ | -62 |      |     |            |
| $C_I$     | Differential input capacitance |                            |                           |     | 1.4  |     | pF         |
| $R_I$     | Input resistance               |                            |                           |     | 300  |     | k $\Omega$ |
| $R_O$     | Output resistance              | Open loop                  |                           |     | 13   |     | $\Omega$   |
| $I_{CC}$  | Quiescent current              | $V_{CC} = \pm 5\text{ V}$  | $T_A = 25^\circ\text{C}$  |     | 8.5  | 10  | mA         |
|           |                                |                            | $T_A = \text{full range}$ |     |      | 12  |            |
|           |                                | $V_{CC} = \pm 15\text{ V}$ | $T_A = 25^\circ\text{C}$  |     | 11.5 | 13  |            |
|           |                                |                            | $T_A = \text{full range}$ |     |      | 15  |            |

† Full range is  $0^\circ\text{C}$  to  $70^\circ\text{C}$  for the THS6002C and  $-40^\circ\text{C}$  to  $85^\circ\text{C}$  for the THS6002I.

**operating characteristics,  $V_{CC} = \pm 15\text{ V}$ ,  $R_L = 25\ \Omega$ ,  $R_F = 1\ \text{k}\Omega$ ,  $T_A = 25^\circ\text{C}$  (unless otherwise noted)**

| PARAMETER                         |                                | TEST CONDITIONS  |   | MIN | TYP   | MAX | UNIT                   |
|-----------------------------------|--------------------------------|--|---|-----|-------|-----|------------------------|
| SR                                | Differential slew rate         | $V_O = 20\text{ V}_{(PP)}$ , $G = 2$   |   |     | 1000  |     | V/ $\mu\text{s}$       |
| $t_s$                             | Settling time to 0.1%          | 0 V to 10 V Step, $G = 2$  |   |     | 70    |     | ns                     |
| THD                               | Total harmonic distortion      | $V_{O(PP)} = 20\text{ V}$ , $R_F = 4\ \text{k}\Omega$ , $G = 5$ , $f = 1\ \text{MHz}$          |   |     | -62   |     | dBc                    |
| $V_n$                             | Input voltage noise            | $V_{CC} = \pm 5\text{ V}$ or $\pm 15\text{ V}$ , $G = 2$ , $f = 10\ \text{kHz}$ , Single-ended |   |     | 1.7   |     | nV/ $\sqrt{\text{Hz}}$ |
| $I_n$                             | Input noise current            | Positive (IN+)   | $V_{CC} = \pm 5\text{ V}$ or $\pm 15\text{ V}$ , $G = 2$ , $f = 10\ \text{kHz}$ , |     | 11.5  |     | pA/ $\sqrt{\text{Hz}}$ |
|                                   |                                | Negative (IN-)   |   |     | 16    |     |                        |
| BW                                | Small-signal bandwidth (-3 dB) | $V_I = 200\ \text{mV}$ , $G = 1$ , $R_F = 680\ \Omega$   | $V_{CC} = \pm 5\text{ V}$   | 90  | 110   |     | MHz                    |
|                                   |                                |  | $V_{CC} = \pm 15\text{ V}$  | 110 | 140   |     | MHz                    |
|                                   |                                | $V_I = 200\ \text{mV}$ , $G = 2$ , $R_F = 620\ \Omega$   | $V_{CC} = \pm 15\text{ V}$  |     | 120   |     | MHz                    |
|                                   |                                |  | $V_{CC} = \pm 15\text{ V}$  |     | 315   |     | MHz                    |
|                                   | Bandwidth for 0.1 dB flatness  | $V_I = 200\ \text{mV}$ , $G = 1$ , $R_F = 680\ \Omega$   | $V_{CC} = \pm 15\text{ V}$  |     | 265   |     | MHz                    |
|                                   |                                |  | $V_{CC} = \pm 5\text{ V}$   |     | 30    |     | MHz                    |
| Full power bandwidth (see Note 3) |                                | $V_O = 20\text{ V}_{(PP)}$   |   |     | 16    |     | MHz                    |
| $A_D$                             | Differential gain error        | $G = 2$ , $R_L = 150\ \Omega$ , NTSC, 40 IRE   | $V_{CC} = \pm 5\text{ V}$   |     | 0.04% |     |                        |
|                                   |                                |  | $V_{CC} = \pm 15\text{ V}$  |     | 0.05% |     |                        |
| $\phi_D$                          | Differential phase error       | $G = 2$ , $R_L = 150\ \Omega$ , NTSC, 40 IRE   | $V_{CC} = \pm 5\text{ V}$   |     | 0.07° |     |                        |
|                                   |                                |  | $V_{CC} = \pm 15\text{ V}$  |     | 0.08° |     |                        |

NOTE 3: Full power bandwidth = slew rate/ $2\pi V_{\text{peak}}$



# THS6002

## DUAL DIFFERENTIAL LINE DRIVERS AND RECEIVERS

SLOS202D– JANUARY 1998– REVISED JULY 1999

### RECEIVER

electrical characteristics,  $V_{CC} = \pm 15\text{ V}$ ,  $R_L = 150\ \Omega$ ,  $R_F = 1\text{ k}\Omega$ ,  $T_A = 25^\circ\text{C}$  (unless otherwise noted)

| PARAMETER                  |   | TEST CONDITIONST                               |  | MIN                       | TYP        | MAX        | UNIT                         |
|----------------------------|---|--|--|---------------------------|------------|------------|------------------------------|
| $V_{CC}$                   | Power supply operating range              | Split supply                                   |  | $\pm 4.5$                 |            | $\pm 16.5$ | V                            |
|                            |   | Single supply                                  |  | 9                         |            | 33         |                              |
| $V_O$                      | Output voltage swing                      | Single ended                                   | $V_{CC} = \pm 5\text{ V}$  | $\pm 3$                   | $\pm 3.3$  |            | V                            |
|                            |   |  | $V_{CC} = \pm 15\text{ V}$   | $\pm 12.4$                | $\pm 12.8$ |            |                              |
| $V_{ICR}$                  | Common-mode input voltage range           | $V_{CC} = \pm 5\text{ V}$                      |  | $\pm 3.6$                 | $\pm 3.7$  |            | V                            |
|                            |   | $V_{CC} = \pm 15\text{ V}$                     |  | $\pm 13.4$                | $\pm 13.5$ |            |                              |
| $V_{IO}$                   | Input offset voltage                      | Single ended                                   | $V_{CC} = \pm 5\text{ V}$ or $\pm 15\text{ V}$                             | $T_A = 25^\circ\text{C}$  | 1          | 4          | mV                           |
|                            |   |  |  | $T_A = \text{full range}$ |            | 6          |                              |
|                            |   | Differential                                   |  | $T_A = 25^\circ\text{C}$  | 1.5        | 4          |                              |
|                            |   |  |  | $T_A = \text{full range}$ |            | 5          |                              |
| Input offset voltage drift | Single ended                              | $V_{CC} = \pm 5\text{ V}$ or $\pm 15\text{ V}$ |  |                           |            | 20         | $\mu\text{V}/^\circ\text{C}$ |
|                            | Differential                              |  |  |                           |            | 10         |                              |
| $I_{IB}$                   | Input bias current                        | Negative                                       | $V_{CC} = \pm 5\text{ V}$ or $\pm 15\text{ V}$                             | $T_A = 25^\circ\text{C}$  | 2          | 8          | $\mu\text{A}$                |
|                            |   |  |  | $T_A = \text{full range}$ |            | 10         |                              |
|                            |   | Positive                                       |  | $T_A = 25^\circ\text{C}$  | 3.5        | 9          |                              |
|                            |   |  |  | $T_A = \text{full range}$ |            | 11         |                              |
|                            |   | Differential                                   |  | $T_A = 25^\circ\text{C}$  | 1.5        | 8          |                              |
|                            |   |  |  | $T_A = \text{full range}$ |            | 10         |                              |
| $I_O$                      | Output current (see Note 2)               | $V_{CC} = \pm 5\text{ V}$ $R_L = 25\ \Omega$   |  |                           | 95         |            | mA                           |
|                            |   | $V_{CC} = \pm 15\text{ V}$ $R_L = 150\ \Omega$ |  | 80                        | 85         |            |                              |
| $I_{OS}$                   | Short-circuit output current (see Note 2) | $R_L = 25\ \Omega$                             |  |                           | 110        |            | mA                           |
|                            | Open loop transresistance                 | $V_{CC} = \pm 5\text{ V}$                      |  |                           | 1.5        |            | M $\Omega$                   |
|                            |   | $V_{CC} = \pm 15\text{ V}$                     |  |                           | 5          |            |                              |
| CMRR                       | Common-mode rejection ratio               | Single ended                                   | $V_{CC} = \pm 5\text{ V}$ or $\pm 15\text{ V}$ , $T_A = \text{full range}$ | 60                        | 70         |            | dB                           |
|                            |   | Differential                                   |  | 100                       |            |            |                              |
|                            | Crosstalk (receiver to receiver)          | $V_I = 200\text{ mV}$ , $f = 1\text{ MHz}$     |  |                           | -67        |            | dB                           |
| PSRR                       | Power supply rejection ratio              | $V_{CC} = \pm 5\text{ V}$                      | $T_A = 25^\circ\text{C}$   | -66                       | -74        |            | dB                           |
|                            |   |  | $T_A = \text{full range}$  |                           | -63        |            |                              |
|                            |   | $V_{CC} = \pm 15\text{ V}$                     | $T_A = 25^\circ\text{C}$   | -65                       | -72        |            |                              |
|                            |   |  | $T_A = \text{full range}$  |                           | -62        |            |                              |
| $R_I$                      | Input resistance                          |  |  |                           | 300        |            | k $\Omega$                   |
| $C_I$                      | Differential input capacitance            |  |  |                           | 1.4        |            | pF                           |
| $R_O$                      | Output resistance                         | Open loop                                      |  |                           | 10         |            | $\Omega$                     |

† Full range is  $0^\circ\text{C}$  to  $70^\circ\text{C}$  for the THS6002C and  $-40^\circ\text{C}$  to  $85^\circ\text{C}$  for the THS6002I.

NOTE 2: A heat sink is required to keep junction temperature below absolute maximum when an output is heavily loaded or shorted. See absolute maximum ratings and Thermal Information section.



# THS6002 DUAL DIFFERENTIAL LINE DRIVERS AND RECEIVERS

SLOS202D– JANUARY 1998– REVISED JULY 1999

## RECEIVER

**electrical characteristics,  $V_{CC} = \pm 15\text{ V}$ ,  $R_L = 150\ \Omega$ ,  $R_F = 1\text{ k}\Omega$ ,  $T_A = 25^\circ\text{C}$  (unless otherwise noted) (continued)**

| PARAMETER |                   | TEST CONDITIONS†           |                           | MIN | TYP | MAX | UNIT |
|-----------|-------------------|----------------------------|---------------------------|-----|-----|-----|------|
| $I_{CC}$  | Quiescent current | $V_{CC} = \pm 5\text{ V}$  | $T_A = 25^\circ\text{C}$  |     | 4.2 | 5.5 | mA   |
|           |                   |                            | $T_A = \text{full range}$ |     |     | 7.5 |      |
|           |                   | $V_{CC} = \pm 15\text{ V}$ | $T_A = 25^\circ\text{C}$  |     | 5   | 7   |      |
|           |                   |                            | $T_A = \text{full range}$ |     |     |     |      |

† Full range is  $0^\circ\text{C}$  to  $70^\circ\text{C}$  for the THS6002C and  $-40^\circ\text{C}$  to  $85^\circ\text{C}$  for the THS6002I.

**operating characteristics,  $V_{CC} = \pm 15\text{ V}$ ,  $R_L = 150\ \Omega$ ,  $R_F = 1\text{ k}\Omega$ ,  $T_A = 25^\circ\text{C}$  (unless otherwise noted)**

| PARAMETER |                                   | TEST CONDITIONS   |   | MIN                        | TYP   | MAX | UNIT                         |
|-----------|-----------------------------------|---|---|----------------------------|-------|-----|------------------------------|
| SR        | Differential slew rate            | $V_O = 10\text{ V}_{(PP)}$ ,                              | $G = 2$   |                            | 900   |     | $\text{V}/\mu\text{s}$       |
| $t_s$     | Settling time to 0.1%             | 10 V Step,  | $G = 2$   |                            | 50    |     | ns                           |
| THD       | Total harmonic distortion         | $V_O(PP) = 20\text{ V}$ ,<br>$G = 5$ ,                    | $R_F = 510\ \Omega$ ,<br>$f = 1\text{ MHz}$                 |                            | -68   |     | dBc                          |
| $V_n$     | Input voltage noise               | $V_{CC} = \pm 5\text{ V}$ or $\pm 15\text{ V}$<br>$G = 2$ | $f = 10\text{ kHz}$ ,                                       |                            | 1.7   |     | $\text{nV}/\sqrt{\text{Hz}}$ |
| $I_n$     | Input current noise               | Positive (IN+)  | $V_{CC} = \pm 5\text{ V}$ or $\pm 15\text{ V}$ ,<br>$G = 2$ | $f = 10\text{ kHz}$ ,      | 11.5  |     | $\text{pA}/\sqrt{\text{Hz}}$ |
|           |                                   | Negative (IN-)  |   |                            | 16    |     |                              |
| BW        | Small-signal bandwidth (-3 dB)    | $V_I = 200\text{ mV}$ ,<br>$R_F = 560\ \Omega$            | $G = 1$ ,   | $V_{CC} = \pm 5\text{ V}$  | 270   | 300 | MHz                          |
|           |                                   |   |   | $V_{CC} = \pm 15\text{ V}$ | 300   | 330 |                              |
|           | Bandwidth for 0.1 dB flatness     | $V_I = 200\text{ mV}$ ,<br>$R_F = 430\ \Omega$            | $G = 2$ ,   | $V_{CC} = \pm 15\text{ V}$ | 285   |     | MHz                          |
|           |                                   |   |   | $V_{CC} = \pm 5\text{ V}$  | 20    |     | MHz                          |
|           |                                   |   | $V_{CC} = \pm 15\text{ V}$                                  | 25                         |       |     |                              |
|           | Full power bandwidth (see Note 3) | $V_O = 20\text{ V}_{(PP)}$                                |   |                            | 14    |     | MHz                          |
| $A_D$     | Differential gain error           | 40 IRE,<br>$R_L = 150\ \Omega$ ,                          | $G = 2$ ,<br>NTSC   | $V_{CC} = \pm 5\text{ V}$  | 0.09% |     |                              |
|           |                                   |   |   | $V_{CC} = \pm 15\text{ V}$ | 0.1%  |     |                              |
| $\phi_D$  | Differential phase error          | 40 IRE,<br>$R_L = 150\ \Omega$ ,                          | $G = 2$ ,<br>NTSC   | $V_{CC} = \pm 5\text{ V}$  | 0.13° |     |                              |
|           |                                   |   |   | $V_{CC} = \pm 15\text{ V}$ | 0.16° |     |                              |

NOTE 3: Full power bandwidth =  $\text{slew rate}/2\pi V_{\text{peak}}$

PARAMETER MEASUREMENT INFORMATION

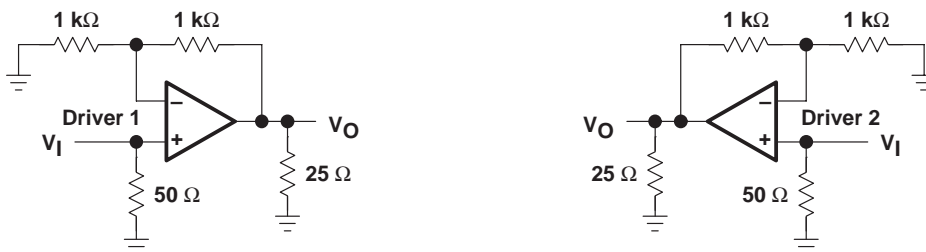

Figure 1. Driver Input-to-Output Crosstalk Test Circuit

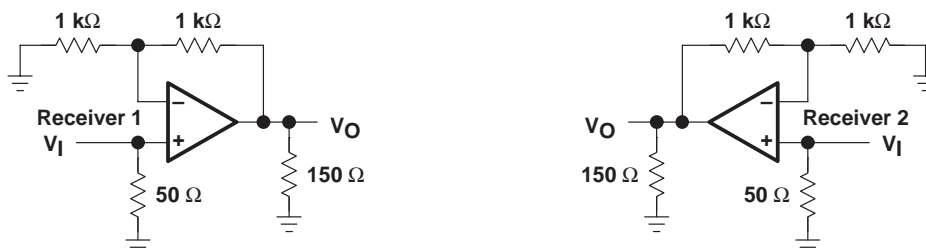

Figure 2. Receiver Input-to-Output Crosstalk Test Circuit

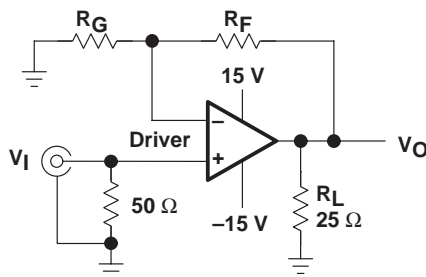

Figure 3. Driver Test Circuit, Gain =  $1 + (R_F/R_G)$

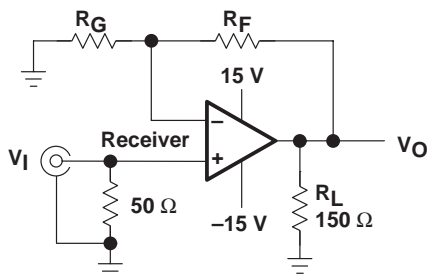

Figure 4. Receiver Test Circuit, Gain =  $1 + (R_F/R_G)$



# THS6002 DUAL DIFFERENTIAL LINE DRIVERS AND RECEIVERS

SLOS202D– JANUARY 1998– REVISED JULY 1999

## TYPICAL CHARACTERISTICS

**Table of Graphs**

|                 |   |                     | FIGURE                  |         |
|-----------------|---|---------------------|-------------------------|---------|
|                 | Supply current                            | Driver and Receiver | vs Supply voltage       | 5       |
|                 | Input voltage noise                       | Driver and Receiver | vs Frequency            | 6       |
|                 | Input current noise                       | Driver and Receiver | vs Frequency            | 6       |
|                 | Closed-loop output impedance              | Driver and Receiver | vs Frequency            | 7       |
|                 | Peak-to-peak output voltage swing         | Driver              | vs Supply voltage       | 8       |
|                 |   | Receiver            | vs Supply voltage       | 31      |
|                 | Peak-to-peak output voltage               | Driver              | vs Load resistance      | 9       |
|                 |   | Receiver            | vs Load resistance      | 32      |
| V <sub>IO</sub> | Input offset voltage                      | Driver              | vs Free-air temperature | 10      |
|                 |   | Receiver            | vs Free-air temperature | 33      |
| I <sub>IB</sub> | Input bias current                        | Driver              | vs Free-air temperature | 11      |
|                 |   | Receiver            | vs Free-air temperature | 34      |
| CMMR            | Common-mode rejection ratio               | Driver              | vs Free-air temperature | 12      |
|                 |   | Receiver            | vs Free-air temperature | 35      |
|                 | Input-to-output crosstalk                 | Driver              | vs Frequency            | 13      |
|                 |   | Receiver            | vs Frequency            | 36      |
|                 | Driver-to-receiver crosstalk              |                     | vs Frequency            | 14      |
|                 | Receiver-to-driver crosstalk              |                     | vs Frequency            | 37      |
| PSSR            | Power supply rejection ratio              | Driver              | vs Free-air temperature | 15      |
|                 |   | Receiver            | vs Free-air temperature | 38      |
| I <sub>CC</sub> | Supply current                            | Driver              | vs Free-air temperature | 16      |
|                 |   | Receiver            | vs Free-air temperature | 39      |
|                 | Normalized frequency response             | Driver              | vs Frequency            | 17, 18  |
|                 |   | Receiver            | vs Frequency            | 40, 41  |
|                 | Normalized output response                | Driver              | vs Frequency            | 19 – 22 |
|                 | Single-ended output distortion            | Driver              | vs Output voltage       | 23      |
|                 | Output distortion                         | Receiver            | vs Output voltage       | 42      |
|                 | Small and large signal frequency response | Receiver            |                         | 43, 44  |
|                 | Differential gain                         | Driver              | DC input offset voltage | 24, 25  |
|                 |   |                     | Number of 150-Ω loads   | 26, 27  |
|                 |   | Receiver            | DC input offset voltage | 45, 46  |
|                 |   |                     | Number of 150-Ω loads   | 47, 48  |
|                 | Differential phase                        | Driver              | DC input offset voltage | 24, 25  |
|                 |   |                     | Number of 150-Ω loads   | 26, 27  |
|                 |   | Receiver            | DC input offset voltage | 45, 46  |
|                 |   |                     | Number of 150-Ω loads   | 47, 48  |
|                 | Output step response                      | Driver              |                         | 28 – 30 |
|                 |   | Receiver            |                         | 49 – 51 |

# THS6002 DUAL DIFFERENTIAL LINE DRIVERS AND RECEIVERS

SLOS202D– JANUARY 1998– REVISED JULY 1999

## TYPICAL CHARACTERISTICS

DRIVER AND RECEIVER  
SUPPLY CURRENT  
vs  
SUPPLY VOLTAGE

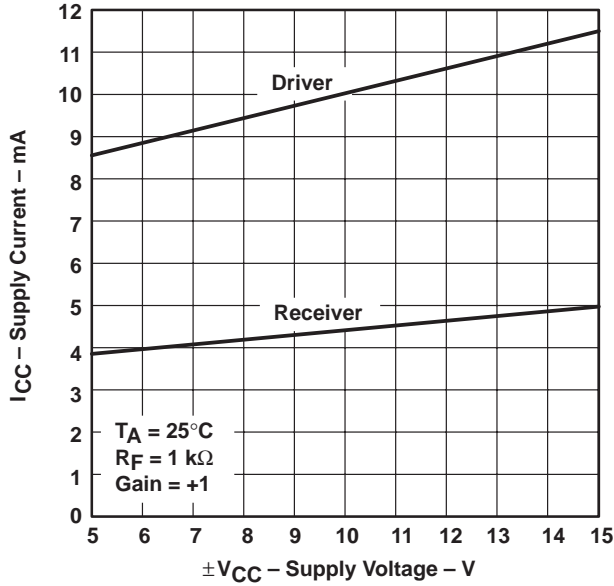

Figure 5

DRIVER AND RECEIVER  
INPUT VOLTAGE AND CURRENT NOISE  
vs  
FREQUENCY

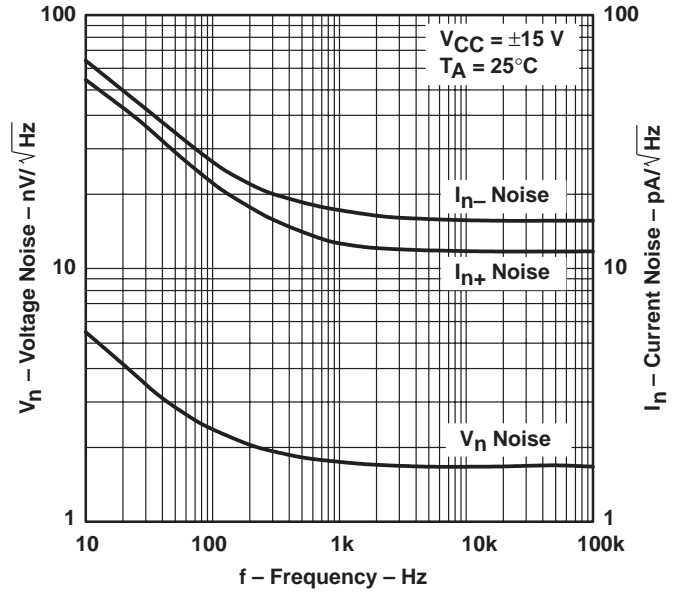

Figure 6

DRIVER AND RECEIVER  
CLOSED-LOOP OUTPUT IMPEDANCE  
vs  
FREQUENCY

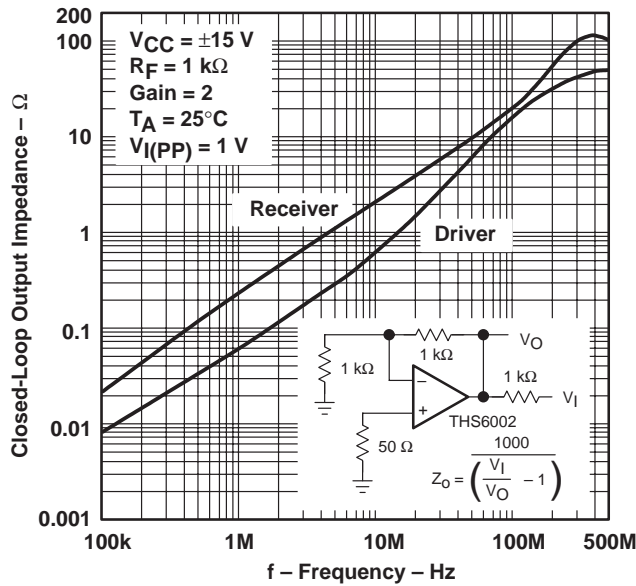
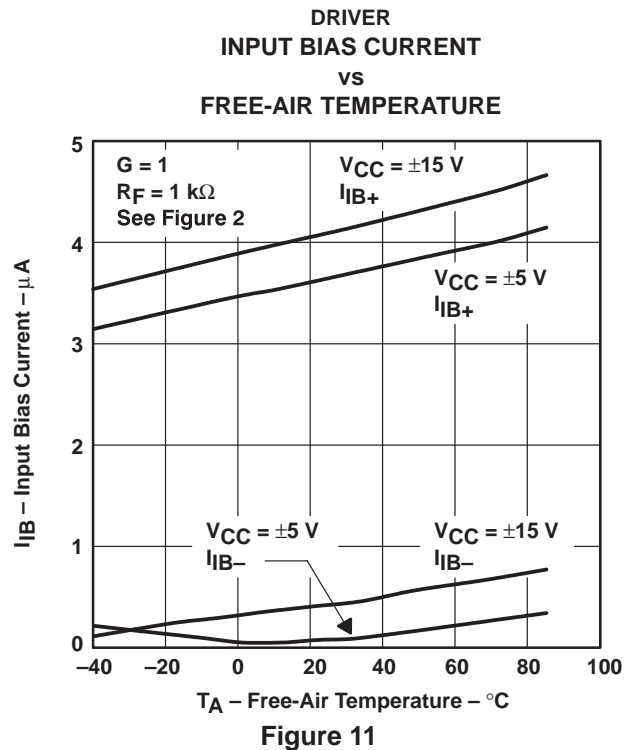
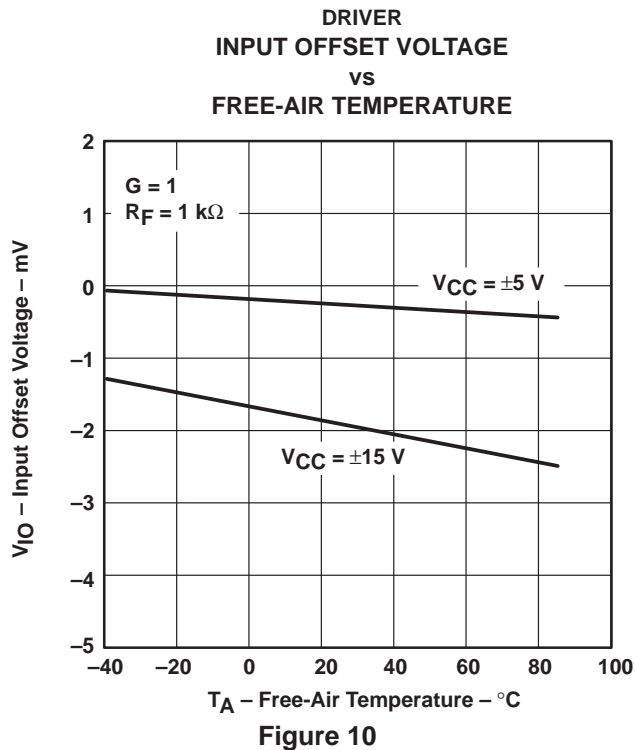
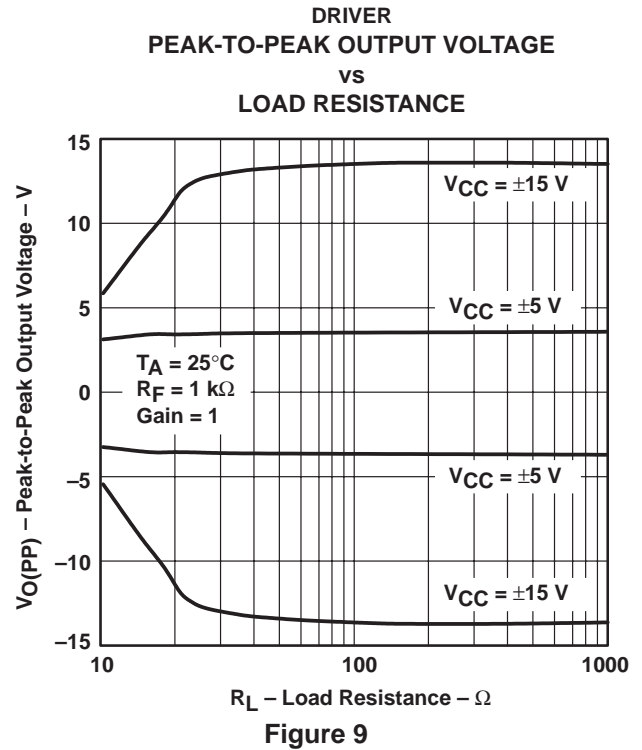
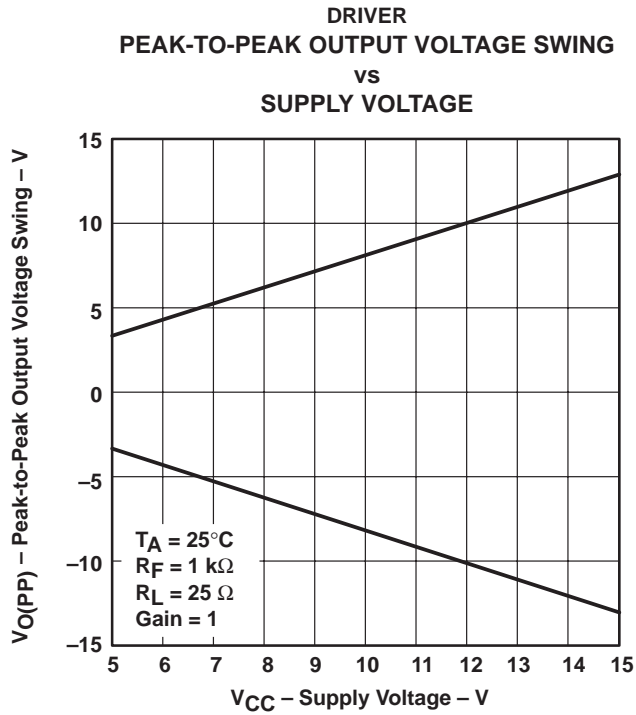

Figure 7

TYPICAL CHARACTERISTICS



# THS6002 DUAL DIFFERENTIAL LINE DRIVERS AND RECEIVERS

SLOS202D— JANUARY 1998— REVISED JULY 1999

## TYPICAL CHARACTERISTICS

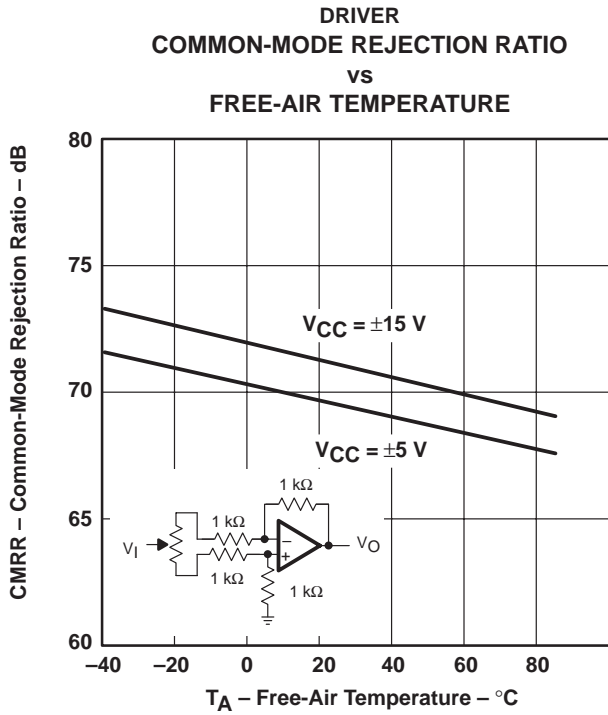

Figure 12

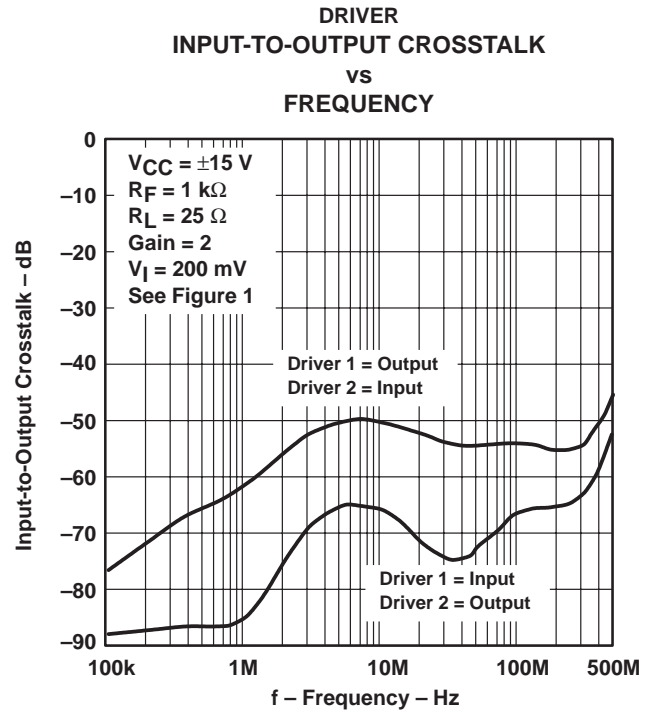

Figure 13

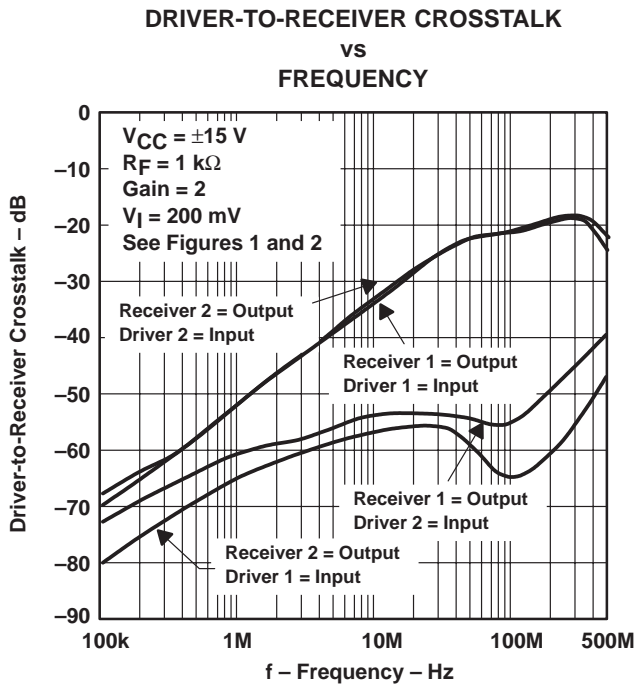

Figure 14

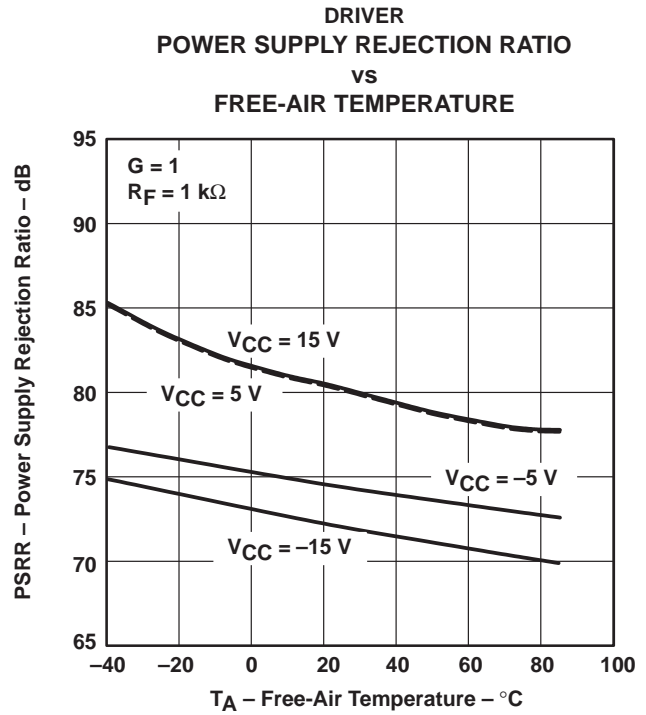
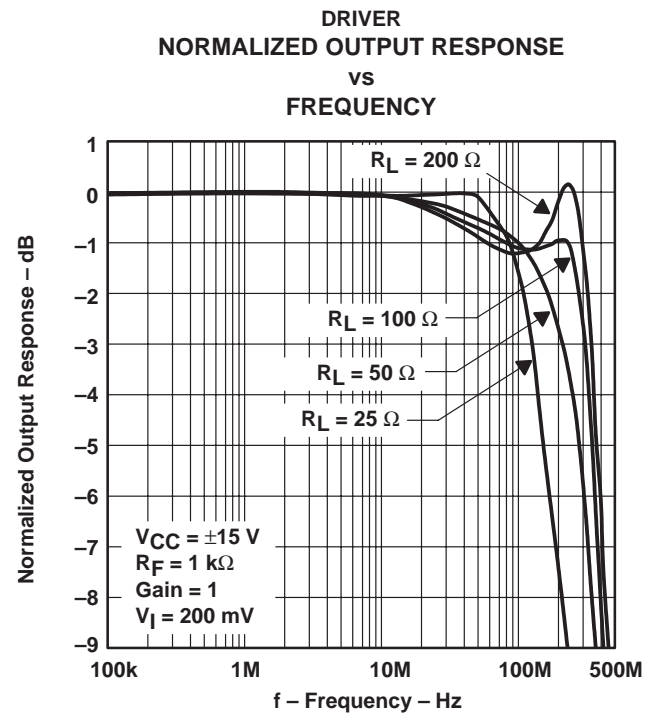
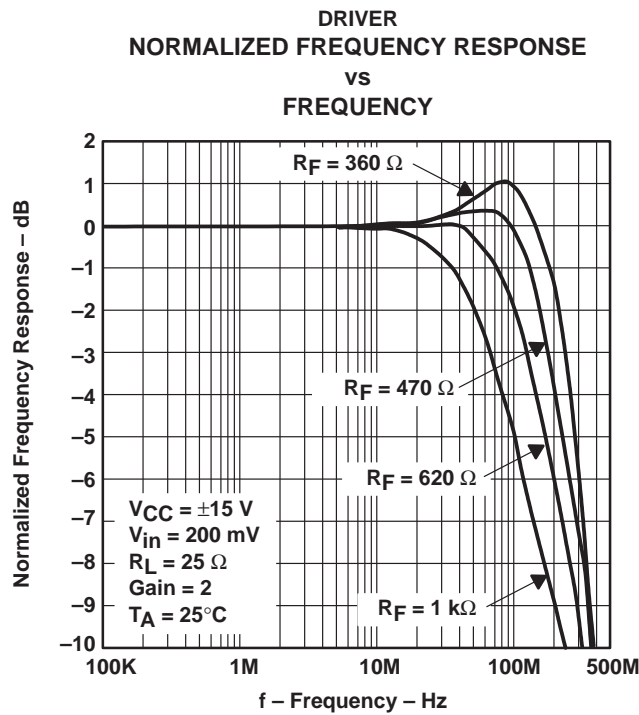
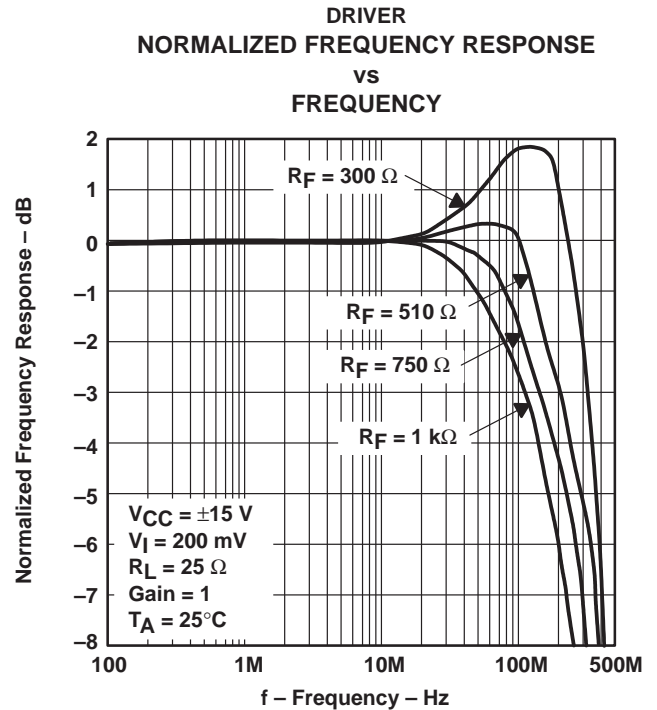
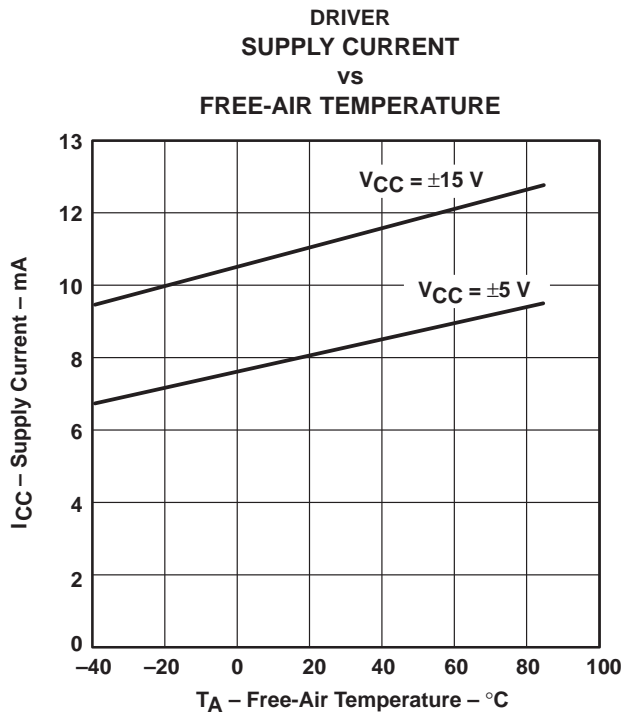

Figure 15



TYPICAL CHARACTERISTICS



# THS6002 DUAL DIFFERENTIAL LINE DRIVERS AND RECEIVERS

SLOS202D– JANUARY 1998– REVISED JULY 1999

## TYPICAL CHARACTERISTICS

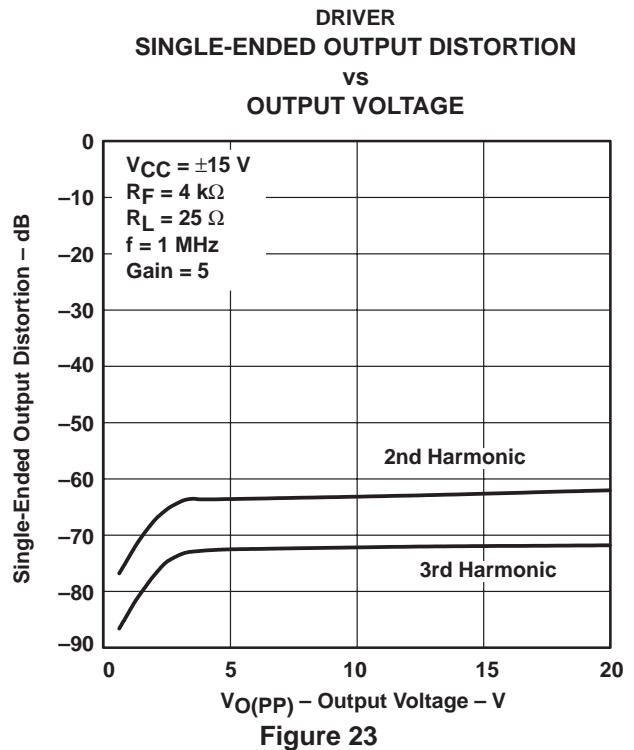
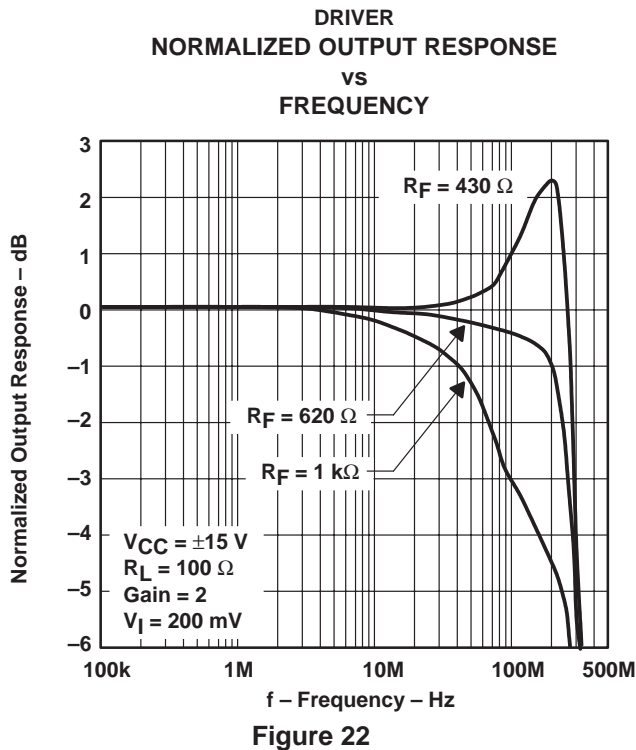
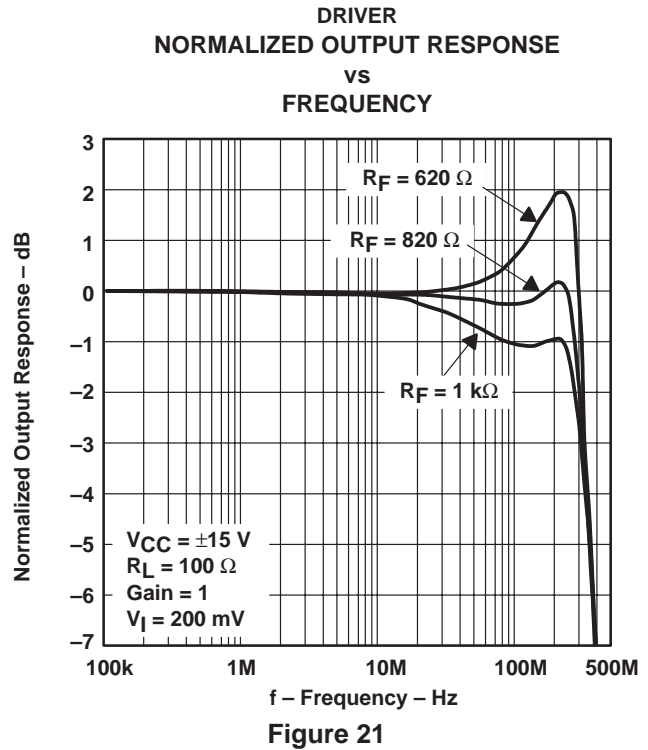
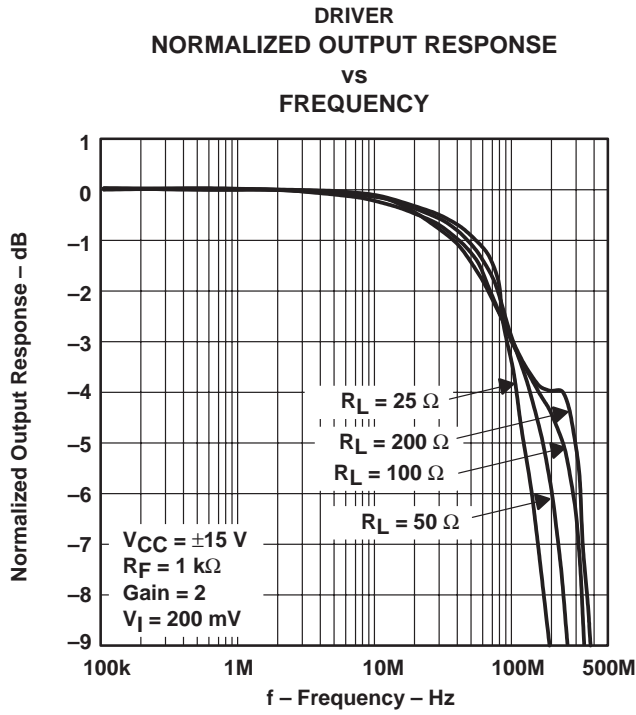

TYPICAL CHARACTERISTICS

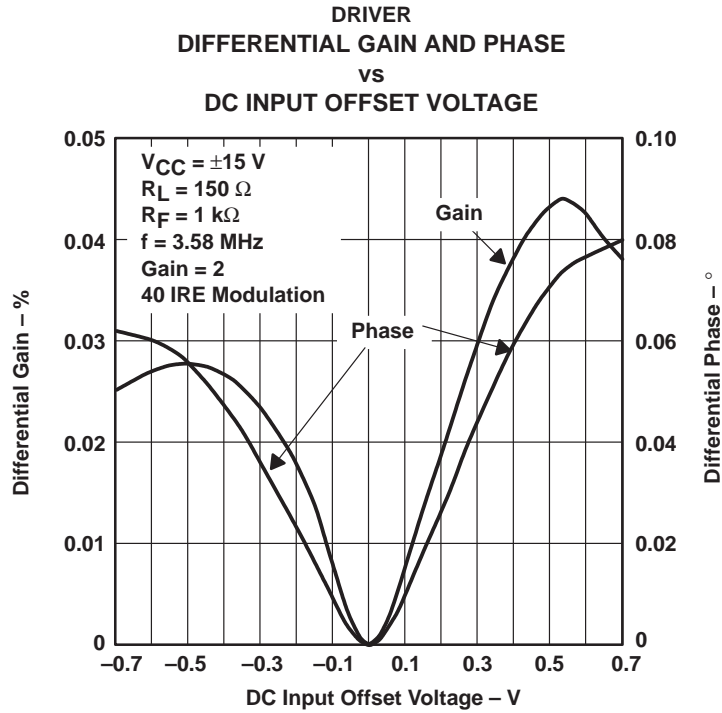

Figure 24

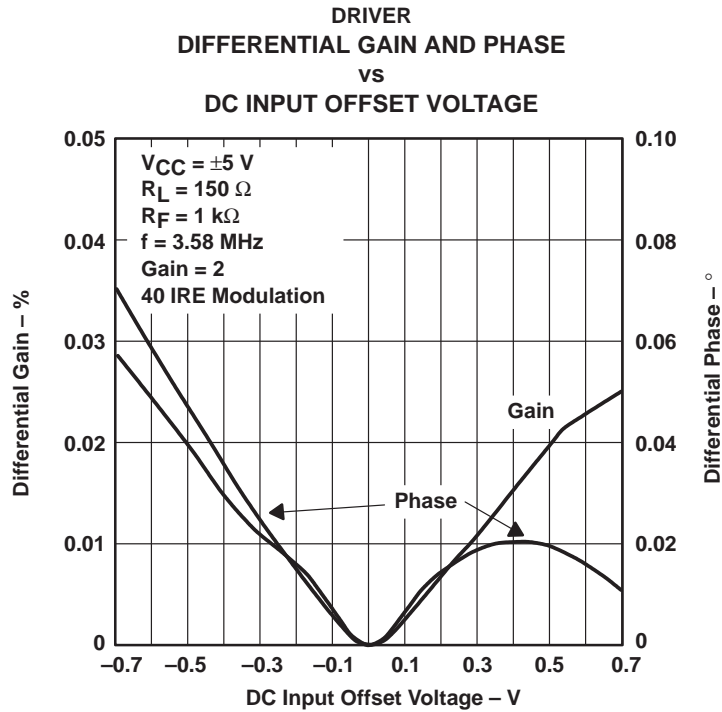

Figure 25

# THS6002 DUAL DIFFERENTIAL LINE DRIVERS AND RECEIVERS

SLOS202D—JANUARY 1998—REVISED JULY 1999

## TYPICAL CHARACTERISTICS

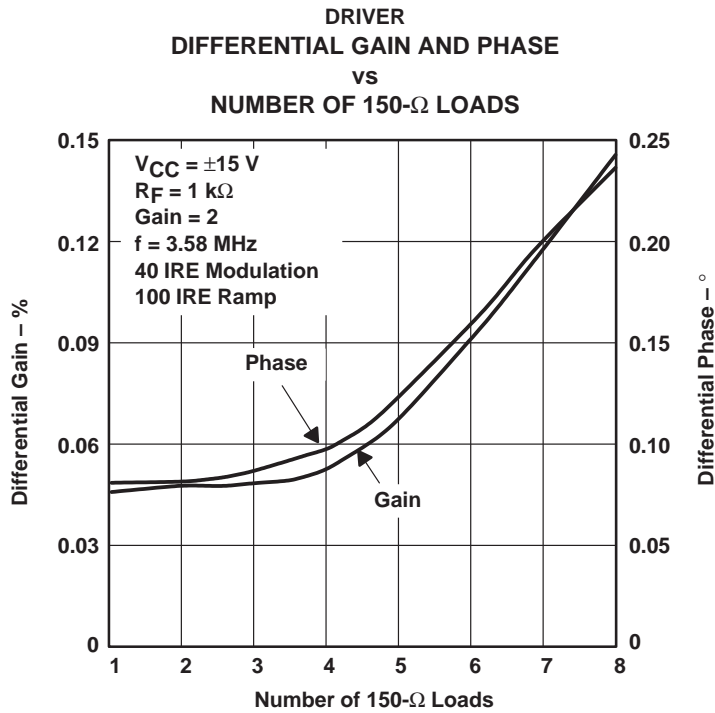

Figure 26

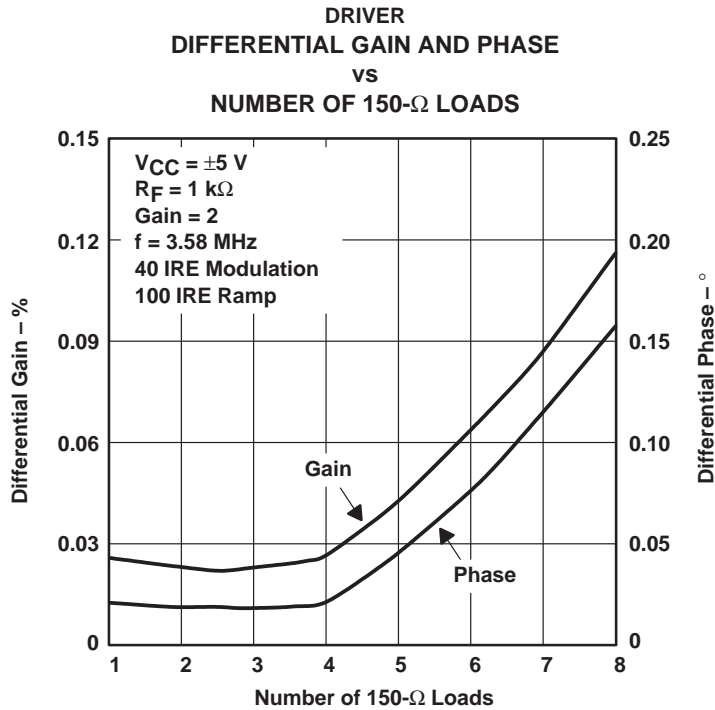
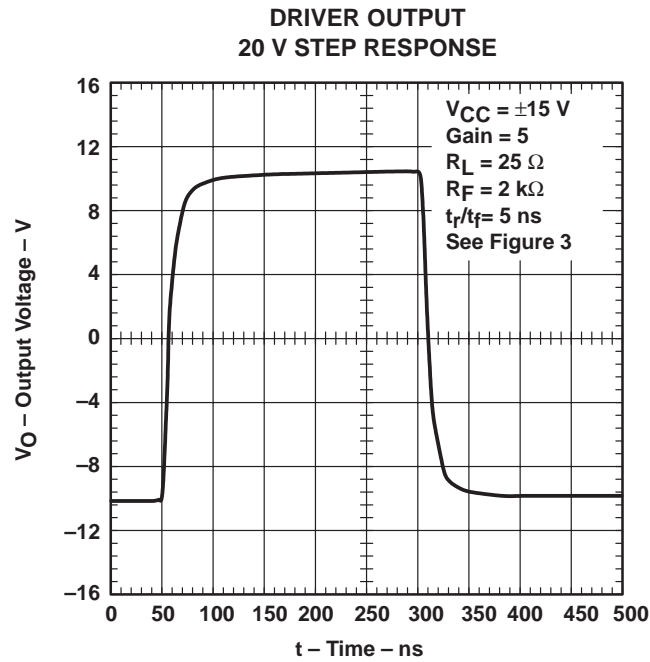
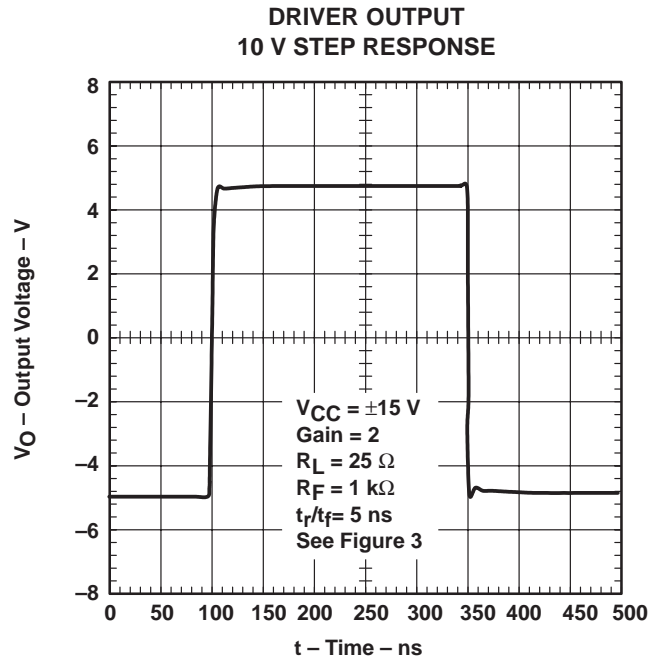
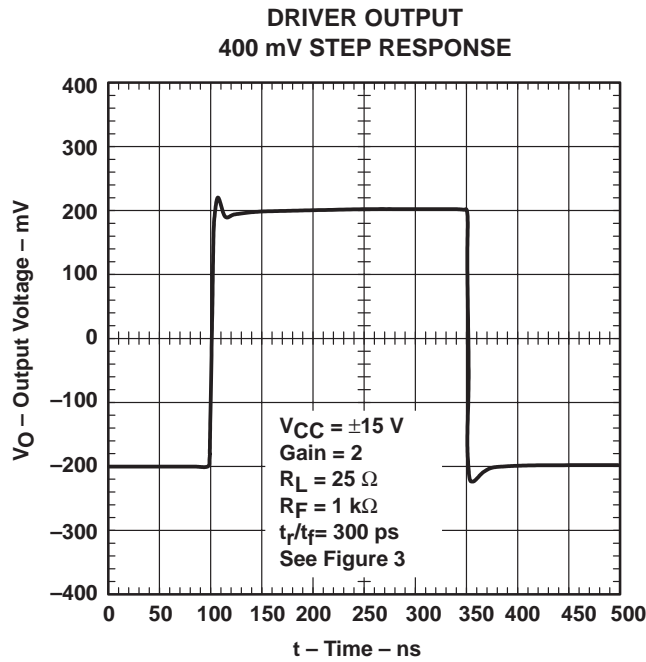

Figure 27





TYPICAL CHARACTERISTICS



# THS6002 DUAL DIFFERENTIAL LINE DRIVERS AND RECEIVERS

SLOS202D– JANUARY 1998– REVISED JULY 1999

## TYPICAL CHARACTERISTICS

RECEIVER  
PEAK-TO-PEAK OUTPUT VOLTAGE SWING  
VS  
SUPPLY VOLTAGE

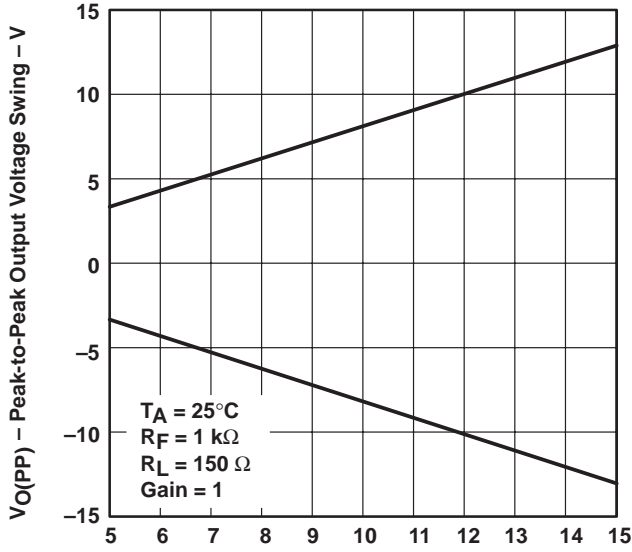

Figure 31

RECEIVER  
PEAK-TO-PEAK OUTPUT VOLTAGE  
VS  
LOAD RESISTANCE

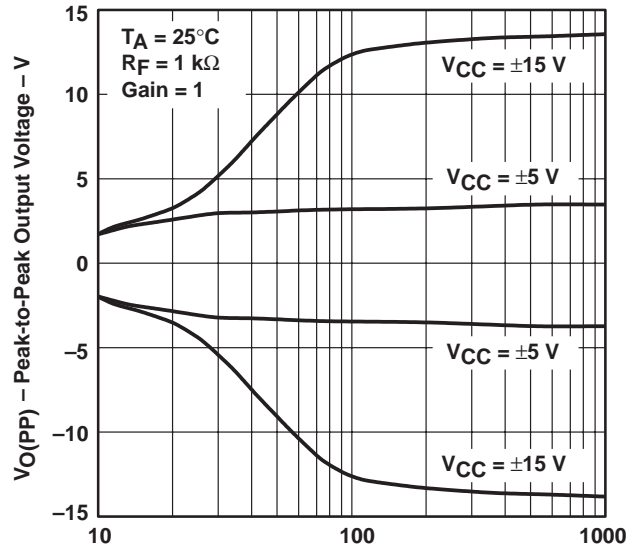

Figure 32

RECEIVER  
INPUT OFFSET VOLTAGE  
VS  
FREE-AIR TEMPERATURE

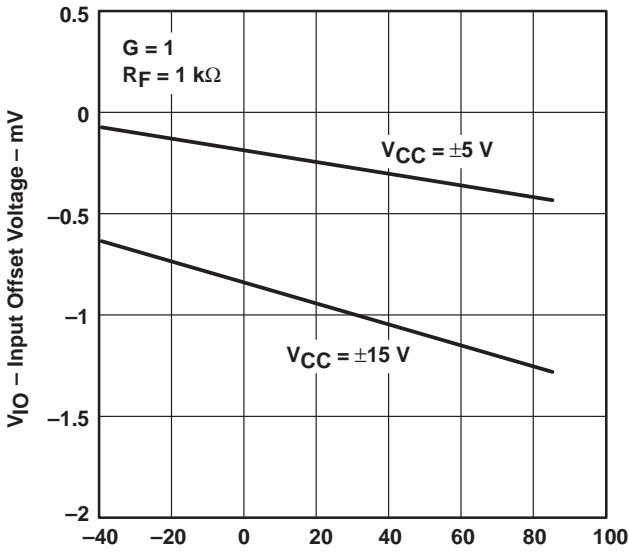

Figure 33

RECEIVER  
INPUT BIAS CURRENT  
VS  
FREE-AIR TEMPERATURE

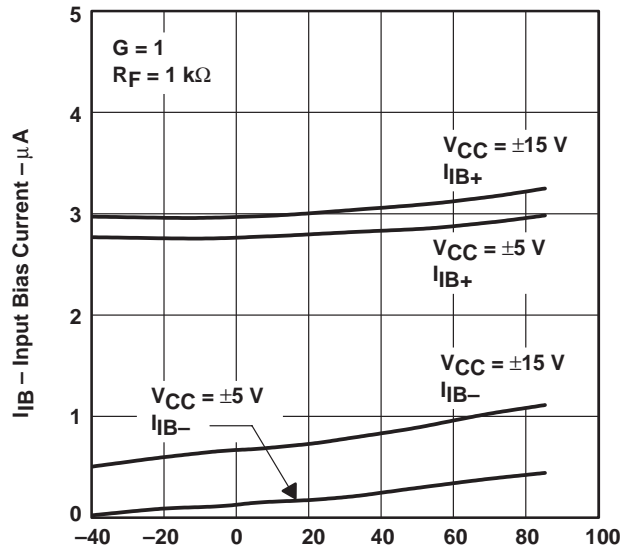
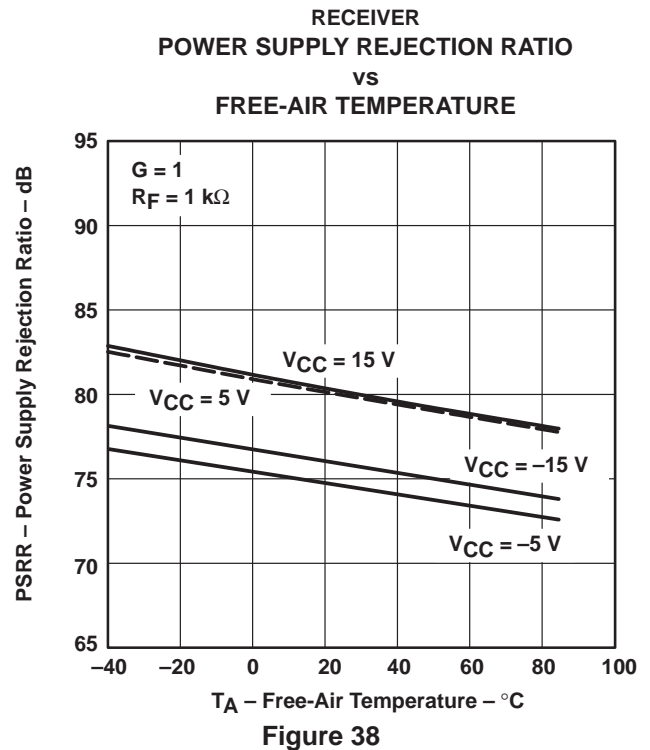
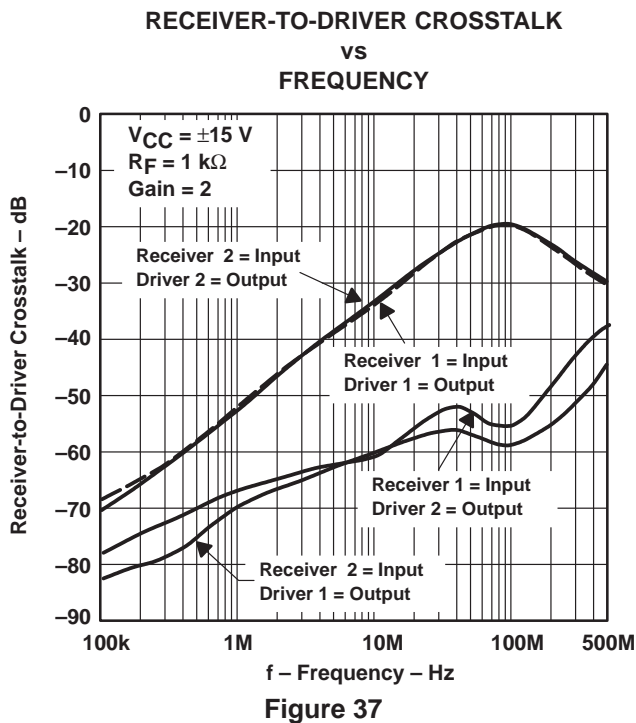
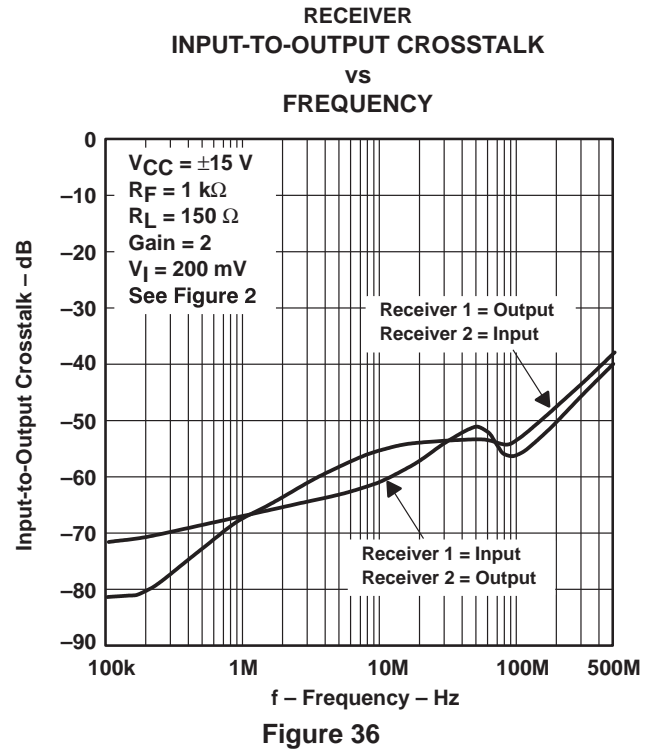
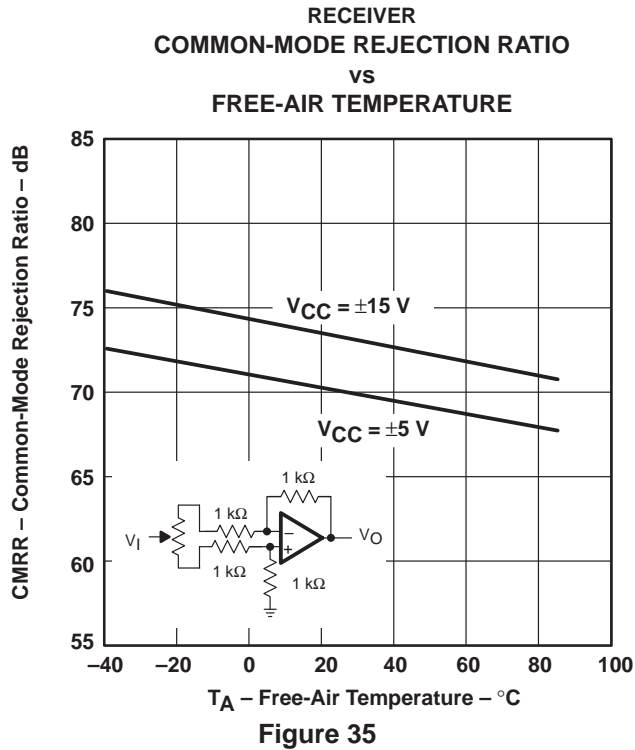

Figure 34



## TYPICAL CHARACTERISTICS



# THS6002 DUAL DIFFERENTIAL LINE DRIVERS AND RECEIVERS

SLOS202D– JANUARY 1998– REVISED JULY 1999

## TYPICAL CHARACTERISTICS

RECEIVER  
SUPPLY CURRENT  
VS  
FREE-AIR TEMPERATURE

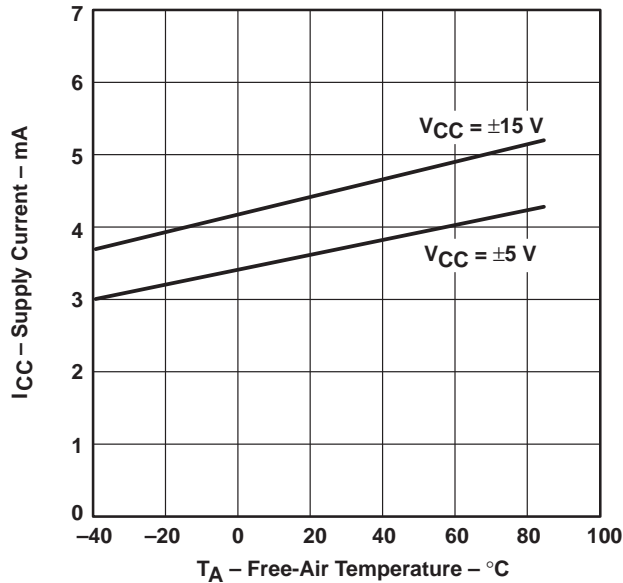

Figure 39

RECEIVER  
NORMALIZED OUTPUT RESPONSE  
VS  
FREQUENCY

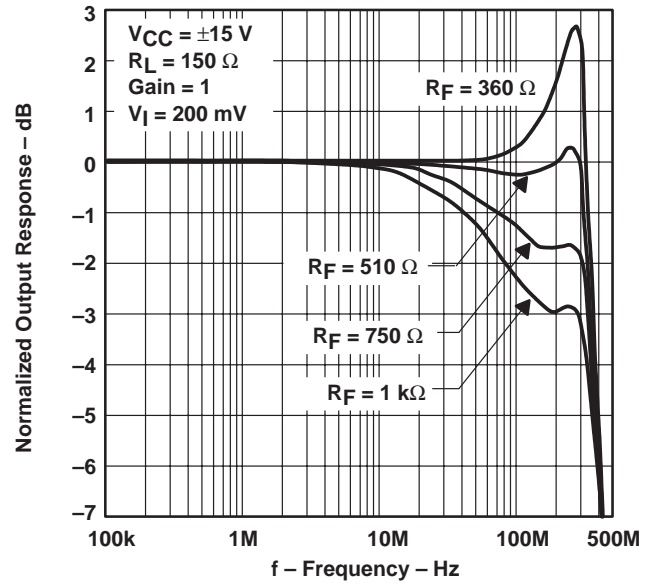

Figure 40

RECEIVER  
NORMALIZED OUTPUT RESPONSE  
VS  
FREQUENCY

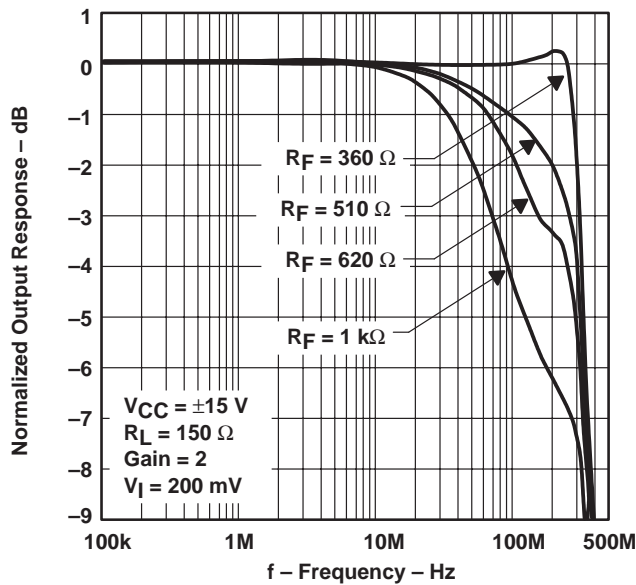

Figure 41

RECEIVER  
OUTPUT DISTORTION  
VS  
OUTPUT VOLTAGE

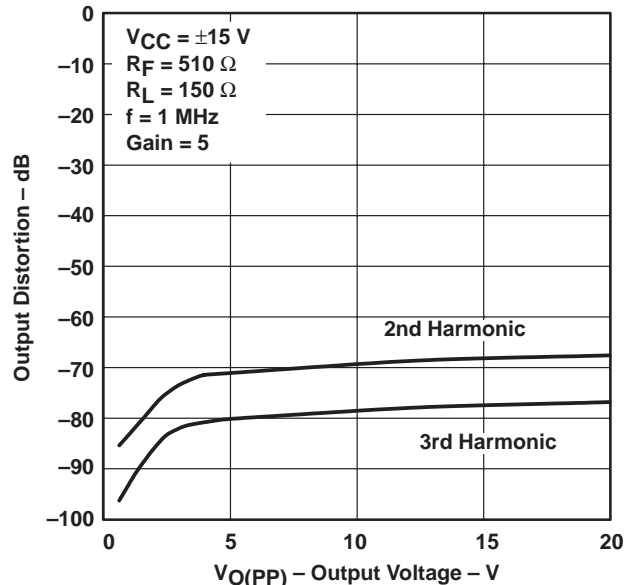
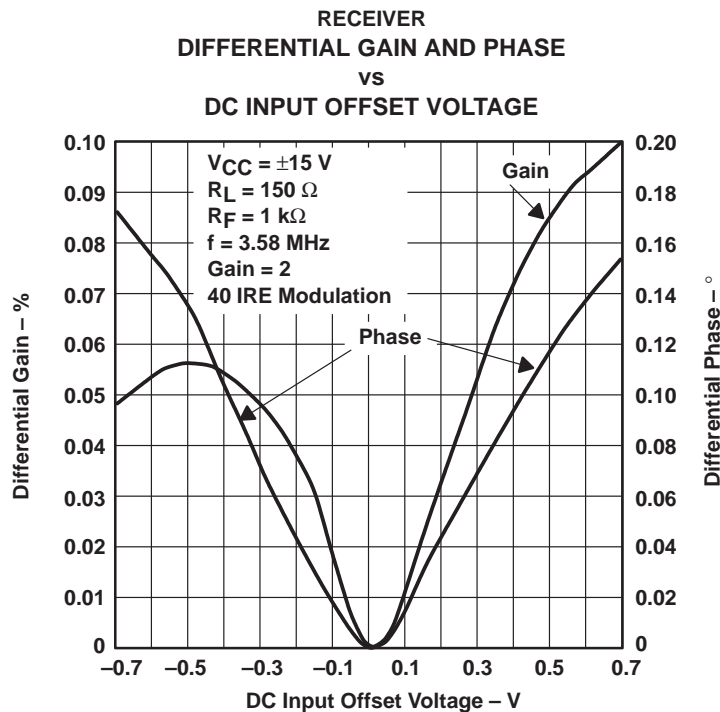
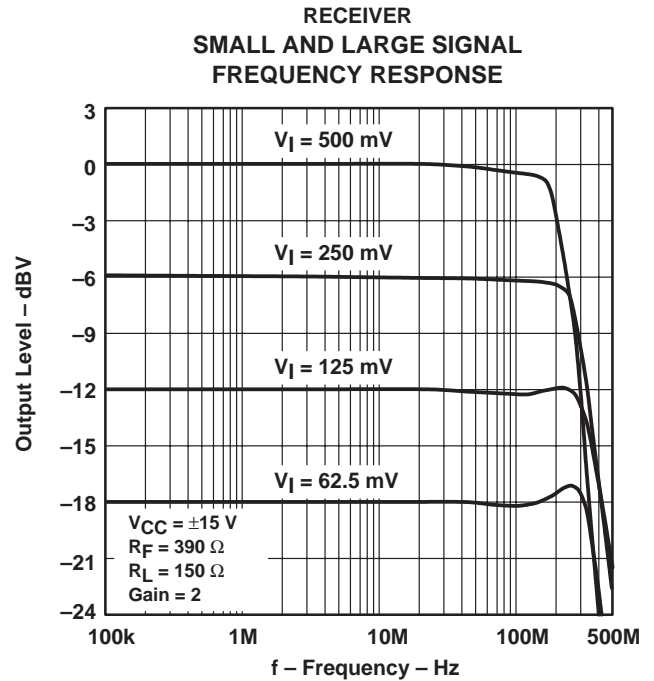
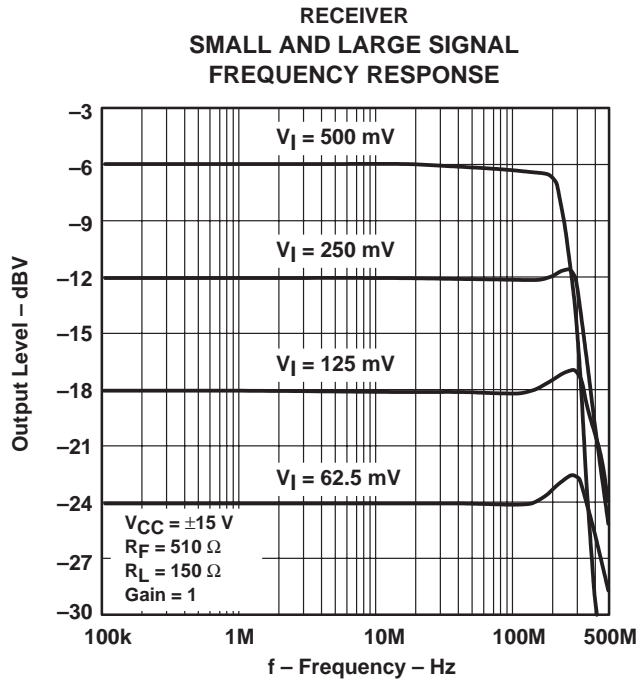

Figure 42

TYPICAL CHARACTERISTICS



# THS6002 DUAL DIFFERENTIAL LINE DRIVERS AND RECEIVERS

SLOS202D– JANUARY 1998– REVISED JULY 1999

## TYPICAL CHARACTERISTICS

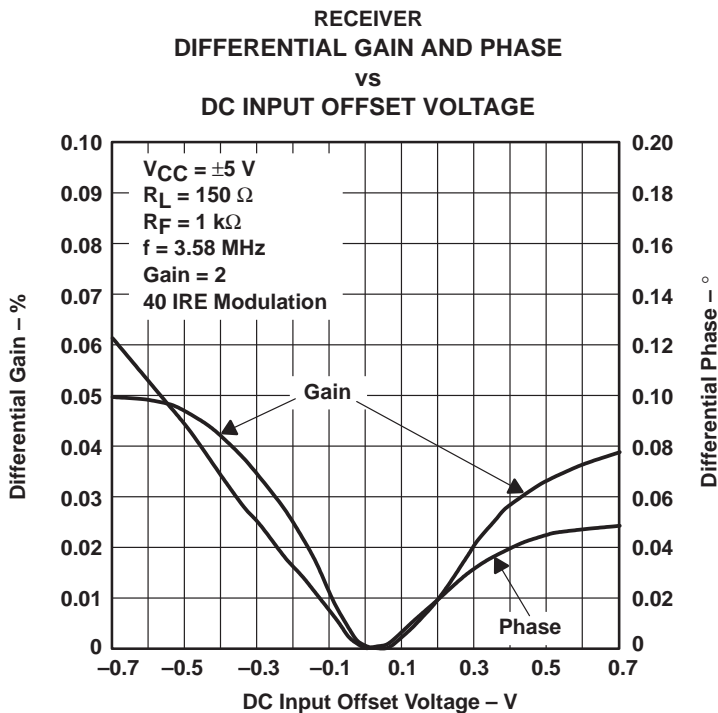

Figure 46

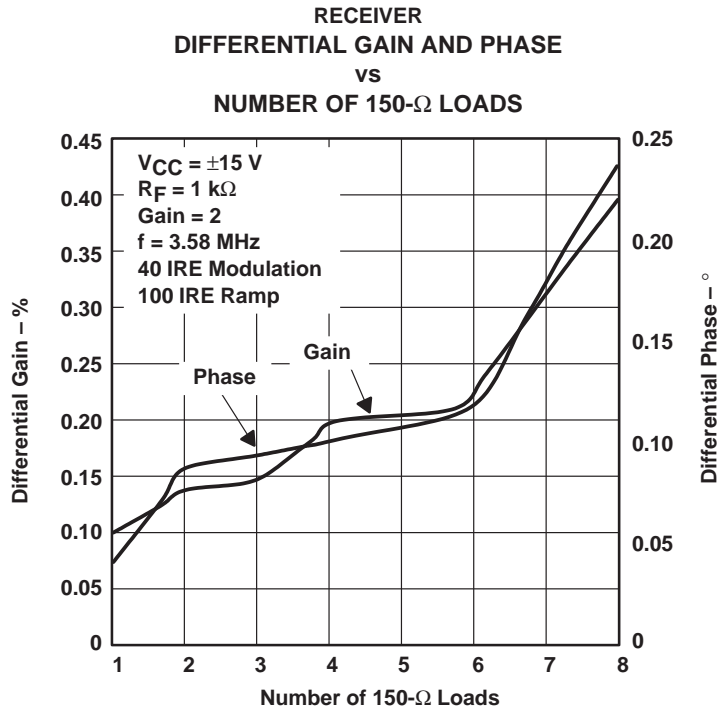

Figure 47



TYPICAL CHARACTERISTICS

RECEIVER  
 DIFFERENTIAL GAIN AND PHASE  
 VS  
 NUMBER OF 150-Ω LOADS

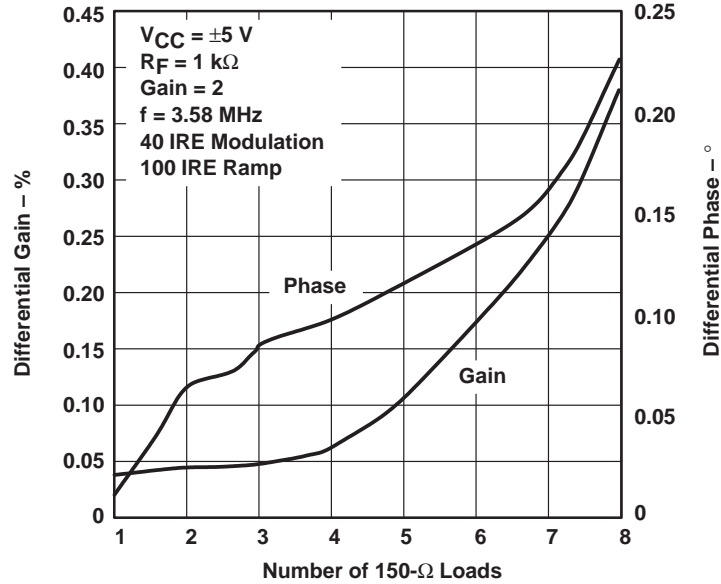

Figure 48

RECEIVER OUTPUT  
 400-mV STEP RESPONSE

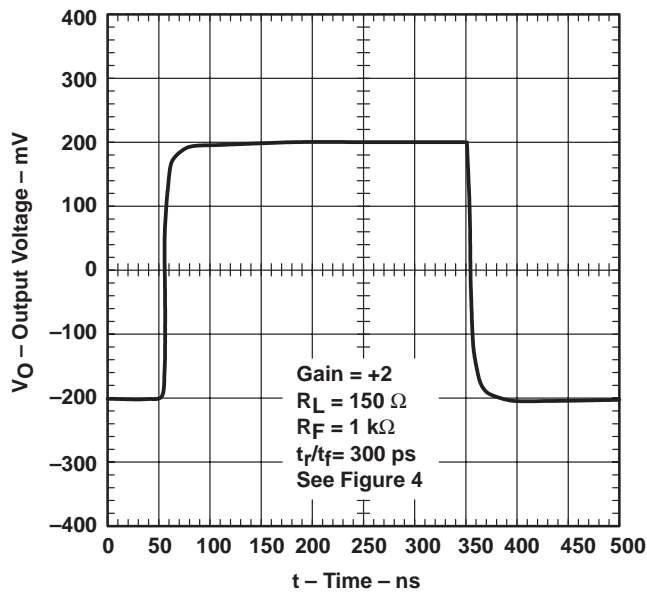

Figure 49

RECEIVER OUTPUT  
 10-V STEP RESPONSE

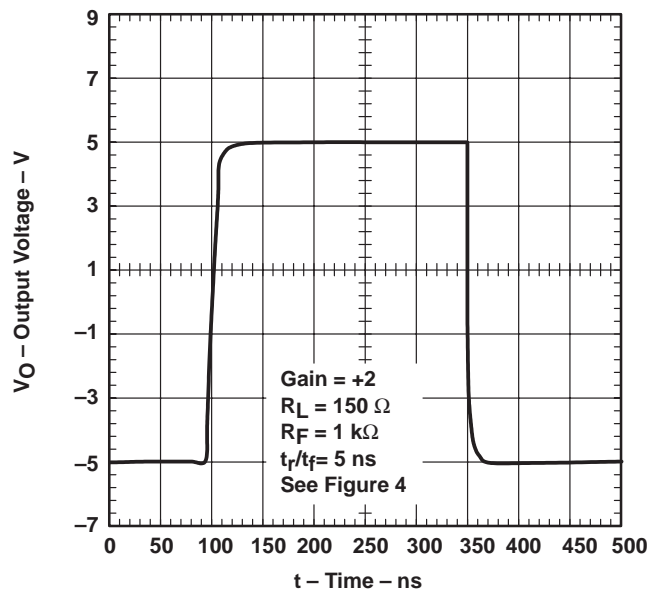
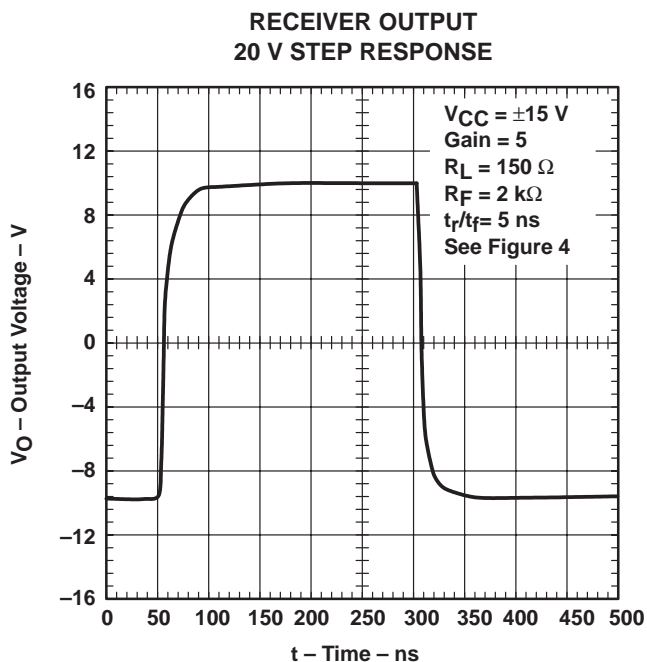

Figure 50

## TYPICAL CHARACTERISTICS



## APPLICATION INFORMATION

The THS6002 contains four independent operational amplifiers. Two are designated as drivers because of their high output current capability, and two are designated as receivers. The receiver amplifiers are current feedback topology amplifiers made for high-speed operation and are capable of driving output loads of at least 80 mA. The drivers are also current feedback topology amplifiers. However, the drivers have been specifically designed to deliver the full power requirements of ADSL and therefore can deliver output currents of at least 400 mA at full output voltage.

The THS6002 is fabricated using Texas Instruments 30-V complementary bipolar process, HVBiCOM. This process provides excellent isolation and high slew rates that result in the device's excellent crosstalk and extremely low distortion.

### independent power supplies

Each amplifier of the THS6002 has its own power supply pins. This was specifically done to solve a problem that often occurs when multiple devices in the same package share common power pins. This problem is crosstalk between the individual devices caused by currents flowing in common connections. Whenever the current required by one device flows through a common connection shared with another device, this current, in conjunction with the impedance in the shared line, produces an unwanted voltage on the power supply. Proper power supply decoupling and good device power supply rejection helps to reduce this unwanted signal. What is left is crosstalk.

However, with independent power supply pins for each device, the effects of crosstalk through common impedance in the power supplies is more easily managed. This is because it is much easier to achieve low common impedance on the PCB with copper etch than it is to achieve low impedance within the package with either bond wires or metal traces on silicon.



## APPLICATION INFORMATION

### power supply restrictions

Although the THS6002 is specified for operation from power supplies of  $\pm 5\text{ V}$  to  $\pm 15\text{ V}$  (or singled-ended power supply operation from  $10\text{ V}$  to  $30\text{ V}$ ), and each amplifier has its own power supply pins, several precautions must be taken to assure proper operation.

1. The power supplies for each amplifier must be the same value. For example, if the drivers use  $\pm 15\text{ volts}$ , then the receivers must also use  $\pm 15\text{ volts}$ . Using  $\pm 15\text{ volts}$  for one amplifier and  $\pm 5\text{ volts}$  for another amplifier is not allowed.
2. To save power by powering down some of the amplifiers in the package, the following rules must be followed.
  - The amplifier designated Receiver 1 must always receive power whenever any other amplifier(s) within the package is used. This is because the internal startup circuitry uses the power from the Receiver 1 device.
  - The  $-V_{CC}$  pins from all four devices must always be at the same potential.
  - Individual amplifiers are powered down by simply opening the  $+V_{CC}$  connection.

As an example, if only the two drivers within the THS6002 are used, then the package power is reduced by removing the  $+V_{CC}$  connection to Receiver 2. This reduces the power consumption by an amount equal to the quiescent power of a single receiver amplifier. The  $+V_{CC}$  connections to Receiver 1 and both drivers are required. Also, all four amplifiers must be connected to  $-V_{CC}$ , including Receiver 2.

The THS6002 incorporates a standard Class A-B output stage. This means that some of the quiescent current is directed to the load as the load current increases. So under heavy load conditions, accurate power dissipation calculations are best achieved through actual measurements. For small loads, however, internal power dissipation for each amplifier in the THS6002 can be approximated by the following formula:

$$P_D \cong (2 V_{CC} I_{CC}) + (V_{CC} - V_O) \times \left( \frac{V_O}{R_L} \right)$$

Where:

- $P_D$  = power dissipation for one amplifier
- $V_{CC}$  = split supply voltage
- $I_{CC}$  = supply current for that particular amplifier
- $V_O$  = output voltage of amplifier
- $R_L$  = load resistance

To find the total THS6002 power dissipation, we simply sum up all four amplifier power dissipation results. Generally, the worst case power dissipation occurs when the output voltage is one-half the  $V_{CC}$  voltage. One last note, which is often overlooked: the feedback resistor ( $R_F$ ) is also a load to the output of the amplifier and should be taken into account for low value feedback resistors.

# THS6002

## DUAL DIFFERENTIAL LINE DRIVERS AND RECEIVERS

SLOS202D– JANUARY 1998– REVISED JULY 1999

### APPLICATION INFORMATION

#### device protection features

The THS6002 has two built-in protection features that protect the device against improper operation. The first protection mechanism is output current limiting. Should the output become shorted to ground the output current is automatically limited to the value given in the data sheet. While this protects the output against excessive current, the device internal power dissipation increases due to the high current and large voltage drop across the output transistors. Continuous output shorts are not recommended and could damage the device. Additionally, connection of the amplifier output to one of the supply rails ( $\pm V_{CC}$ ) can cause failure of the device and is not recommended.

The second built-in protection feature is thermal shutdown. Should the internal junction temperature rise above approximately  $180^{\circ}\text{C}$ , the device automatically shuts down. Such a condition could exist with improper heat sinking or if the output is shorted to ground. When the abnormal condition is fixed, the internal thermal shutdown circuit automatically turns the device back on.

#### thermal information

The THS6002 is packaged in a thermally-enhanced DWP package, which is a member of the PowerPAD family of packages. This package is constructed using a downset leadframe upon which the die is mounted [see Figure 52(a) and Figure 52(b)]. This arrangement results in the lead frame being exposed as a thermal pad on the underside of the package [see Figure 52(c)]. Because this thermal pad has direct thermal contact with the die, excellent thermal performance can be achieved by providing a good thermal path away from the thermal pad.

The PowerPAD package allows for both assembly and thermal management in one manufacturing operation. During the surface-mount solder operation (when the leads are being soldered), the thermal pad can also be soldered to a copper area underneath the package. Through the use of thermal paths within this copper area, heat can be conducted away from the package into either a ground plane or other heat dissipating device. This is discussed in more detail in the *PCB design considerations* section of this document.

The PowerPAD package represents a breakthrough in combining the small area and ease of assembly of surface mount with the, heretofore, awkward mechanical methods of heatsinking.

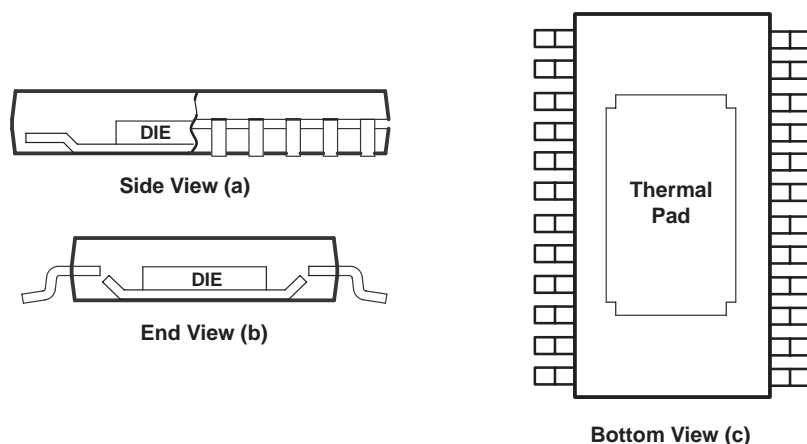

NOTE A: The thermal pad is electrically isolated from all terminals in the package.

**Figure 52. Views of Thermally Enhanced DWP Package**

APPLICATION INFORMATION

recommended feedback and gain resistor values

As with all current feedback amplifiers, the bandwidth of the THS6002 is an inversely proportional function of the value of the feedback resistor. This can be seen from Figures 17 and 18. For the driver, the recommended resistors for the optimum frequency response for a 25-Ω load system are 680-Ω for a gain = 1 and 620-Ω for a gain = 2 or –1. For the receivers, the recommended resistors for the optimum frequency response are 560 Ω for a gain = 1 and 390 Ω for a gain = 2 or –1. These should be used as a starting point and once optimum values are found, 1% tolerance resistors should be used to maintain frequency response characteristics. Because there is a finite amount of output resistance of the operational amplifier, load resistance can play a major part in frequency response. This is especially true with the drivers, which tend to drive low-impedance loads. This can be seen in Figure 7, Figure 19, and Figure 20. As the load resistance increases, the output resistance of the amplifier becomes less dominant at high frequencies. To compensate for this, the feedback resistor should change. For 100-Ω loads, it is recommended that the feedback resistor be changed to 820 Ω for a gain of 1 and 560 Ω for a gain of 2 or –1. Although, for most applications, a feedback resistor value of 1 kΩ is recommended, which is a good compromise between bandwidth and phase margin that yields a very stable amplifier.

Consistent with current feedback amplifiers, increasing the gain is best accomplished by changing the gain resistor, not the feedback resistor. This is because the bandwidth of the amplifier is dominated by the feedback resistor value and internal dominant-pole capacitor. The ability to control the amplifier gain independently of the bandwidth constitutes a major advantage of current feedback amplifiers over conventional voltage feedback amplifiers. Therefore, once a frequency response is found suitable to a particular application, adjust the value of the gain resistor to increase or decrease the overall amplifier gain.

Finally, it is important to realize the effects of the feedback resistance on distortion. Increasing the resistance decreases the loop gain and increases the distortion. It is also important to know that decreasing load impedance increases total harmonic distortion (THD). Typically, the third order harmonic distortion increases more than the second order harmonic distortion.

offset voltage

The output offset voltage, ( $V_{OO}$ ) is the sum of the input offset voltage ( $V_{IO}$ ) and both input bias currents ( $I_{IB}$ ) times the corresponding gains. The following schematic and formula can be used to calculate the output offset voltage:

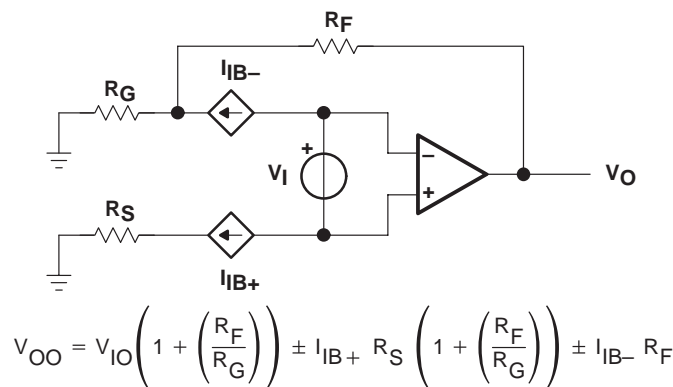

Figure 53. Output Offset Voltage Model

# THS6002

## DUAL DIFFERENTIAL LINE DRIVERS AND RECEIVERS

SLOS202D– JANUARY 1998– REVISED JULY 1999

### APPLICATION INFORMATION

#### noise calculations and noise figure

Noise can cause errors on very small signals. This is especially true for the receiver amplifiers which are generally used for amplifying small signals coming over a transmission line. The noise model for current feedback amplifiers (CFB) is the same as voltage feedback amplifiers (VFB). The only difference between the two is that the CFB amplifiers generally specify different current noise parameters for each input while VFB amplifiers usually only specify one noise current parameter. The noise model is shown in Figure 54. This model includes all of the noise sources as follows:

- $e_n$  = amplifier internal voltage noise ( $\text{nV}/\sqrt{\text{Hz}}$ )
- $IN+$  = noninverting current noise ( $\text{pA}/\sqrt{\text{Hz}}$ )
- $IN-$  = inverting current noise ( $\text{pA}/\sqrt{\text{Hz}}$ )
- $e_{R_x}$  = thermal voltage noise associated with each resistor ( $e_{R_x} = 4 kTR_x$ )

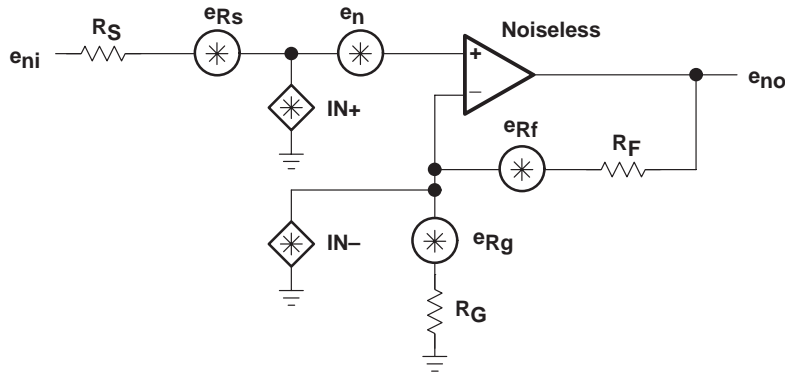

Figure 54. Noise Model

The total equivalent input noise density ( $e_{ni}$ ) is calculated by using the following equation:

$$e_{ni} = \sqrt{(e_n)^2 + (IN+ \times R_S)^2 + (IN- \times (R_F \parallel R_G))^2 + 4 kTR_S + 4 kT(R_F \parallel R_G)}$$

Where:

- $k$  = Boltzmann's constant =  $1.380658 \times 10^{-23}$
- $T$  = temperature in degrees Kelvin ( $273 + ^\circ\text{C}$ )
- $R_F \parallel R_G$  = parallel resistance of  $R_F$  and  $R_G$

To get the equivalent output noise of the amplifier, just multiply the equivalent input noise density ( $e_{ni}$ ) by the overall amplifier gain ( $A_V$ ).

$$e_{no} = e_{ni} A_V = e_{ni} \left( 1 + \frac{R_F}{R_G} \right) \text{ (Noninverting Case)}$$

APPLICATION INFORMATION

noise calculations and noise figure (continued)

As the previous equations show, to keep noise at a minimum, small value resistors should be used. As the closed-loop gain is increased (by reducing  $R_G$ ), the input noise is reduced considerably because of the parallel resistance term. This leads to the general conclusion that the most dominant noise sources are the source resistor ( $R_S$ ) and the internal amplifier noise voltage ( $e_n$ ). Because noise is summed in a root-mean-squares method, noise sources smaller than 25% of the largest noise source can be effectively ignored. This can greatly simplify the formula and make noise calculations much easier to calculate.

This brings up another noise measurement usually preferred in RF applications, the noise figure (NF). Noise figure is a measure of noise degradation caused by the amplifier. The value of the source resistance must be defined and is typically 50  $\Omega$  in RF applications.

$$NF = 10\log \left[ \frac{e_{ni}^2}{e_{Rs}} \right]$$

Because the dominant noise components are generally the source resistance and the internal amplifier noise voltage, we can approximate noise figure as:

$$NF = 10\log \left[ 1 + \frac{\left[ (e_n)^2 + (IN + \times R_S)^2 \right]}{4 kTR_S} \right]$$

The Figure 55 shows the noise figure graph for the THS6002.

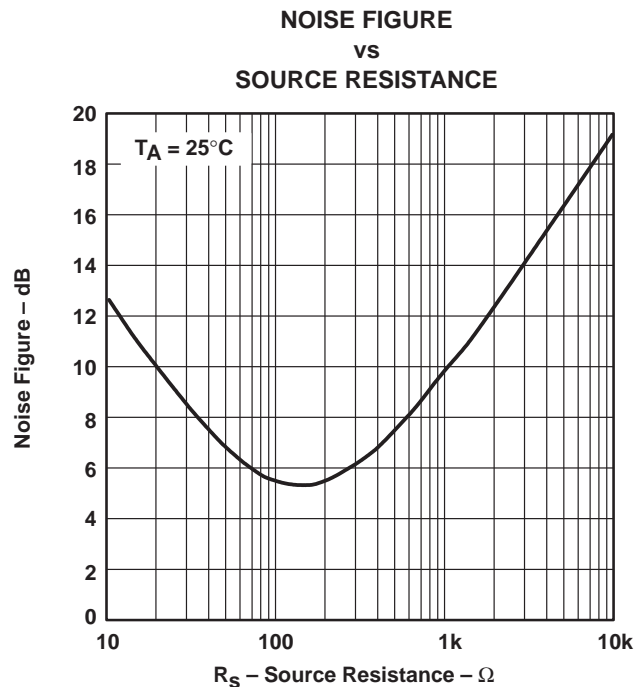

Figure 55. Noise Figure vs. Source Resistance

**APPLICATION INFORMATION**

**PCB design considerations**

Proper PCB design techniques in two areas are important to assure proper operation of the THS6002. These areas are high-speed layout techniques and thermal-management techniques. Because the THS6002 is a high-speed part, the following guidelines are recommended.

- Ground plane – It is essential that a ground plane be used on the board to provide all components with a low inductive ground connection. Although a ground connection directly to a terminal of the THS6002 is not necessarily required, it is recommended that the thermal pad of the package be tied to ground. This serves two functions. It provides a low inductive ground to the device substrate to minimize internal crosstalk and it provides the path for heat removal.
- Input stray capacitance – To minimize potential problems with amplifier oscillation, the capacitance at the inverting input of the amplifiers must be kept to a minimum. To do this, PCB trace runs to the inverting input must be as short as possible, the ground plane must be removed under any etch runs connected to the inverting input, and external components should be placed as close as possible to the inverting input. This is especially true in the noninverting configuration. An example of this can be seen in Figure 56, which shows what happens when 1.8 pF is added to the inverting input terminal in the noninverting configuration. The bandwidth increases dramatically at the expense of peaking. This is because some of the error current is flowing through the stray capacitor instead of the inverting node of the amplifier. Although, in the inverting mode, stray capacitance at the inverting input has little effect. This is because the inverting node is at a *virtual ground* and the voltage does not fluctuate nearly as much as in the noninverting configuration.

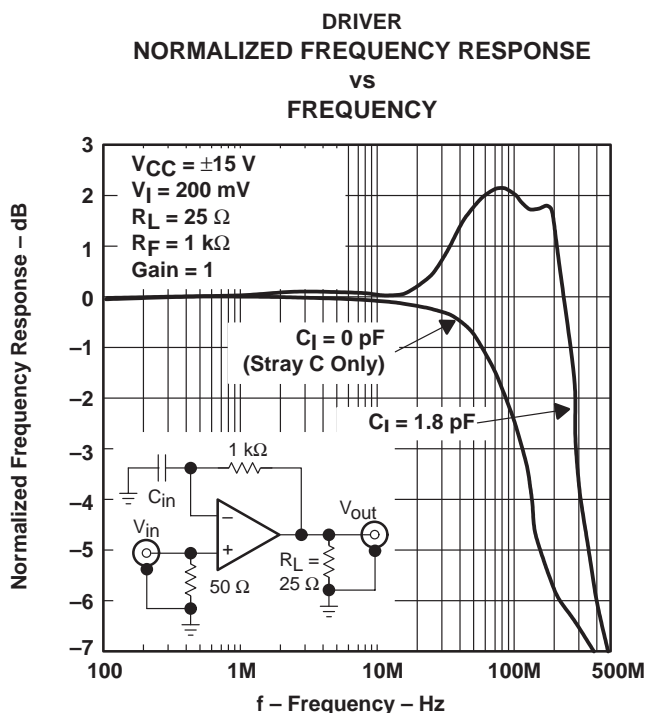

**Figure 56. Driver Normalized Frequency Response vs. Frequency**

## APPLICATION INFORMATION

### PCB design considerations (continued)

- Proper power supply decoupling – Use a minimum of a 6.8- $\mu$ F tantalum capacitor in parallel with a 0.1- $\mu$ F ceramic capacitor on each supply terminal. It may be possible to share the tantalum among several amplifiers depending on the application, but a 0.1- $\mu$ F ceramic capacitor should always be used on the supply terminal of every amplifier. In addition, the 0.1- $\mu$ F capacitor should be placed as close as possible to the supply terminal. As this distance increases, the inductance in the connecting etch makes the capacitor less effective. The designer should strive for distances of less than 0.1 inches between the device power terminal and the ceramic capacitors.

Because of its power dissipation, proper thermal management of the THS6002 is required. Although there are many ways to properly heatsink this device, the following steps illustrate one recommended approach for a multilayer PCB with an internal ground plane.

1. Prepare the PCB with a top side etch pattern as shown in Figure 57. There should be etch for the leads as well as etch for the thermal pad.
2. Place five holes in the area of the thermal pad. These holes should be 13 mils in diameter. They are kept small so that solder wicking through the holes is not a problem during reflow.
3. Place four more holes under the package, but outside the thermal pad area. These holes are 25 mils in diameter. They may be larger because they are not in the area to be soldered so that wicking is not a problem.
4. Connect all nine holes, the five within the thermal pad area and the four outside the pad area, to the internal ground plane.
5. When connecting these holes to the ground plane, do **not** use the typical web or spoke via connection methodology. Web connections have a high thermal resistance connection that is useful for slowing the heat transfer during soldering operations. This makes the soldering of vias that have plane connections easier. However, in this application, low thermal resistance is desired for the most efficient heat transfer. Therefore, the holes under the THS6002 package should make their connection to the internal ground plane with a complete connection around the entire circumference of the plated through hole.
6. The top-side solder mask should leave exposed the terminals of the package and the thermal pad area with its five holes. The four larger holes outside the thermal pad area, but still under the package, should be covered with solder mask.
7. Apply solder paste to the exposed thermal pad area and all of the operational amplifier terminals.
8. With these preparatory steps in place, the THS6002 is simply placed in position and run through the solder reflow operation as any standard surface mount component. This results in a part that is properly installed.

# THS6002

## DUAL DIFFERENTIAL LINE DRIVERS AND RECEIVERS

SLOS202D– JANUARY 1998– REVISED JULY 1999

### APPLICATION INFORMATION

#### PCB design considerations (continued)

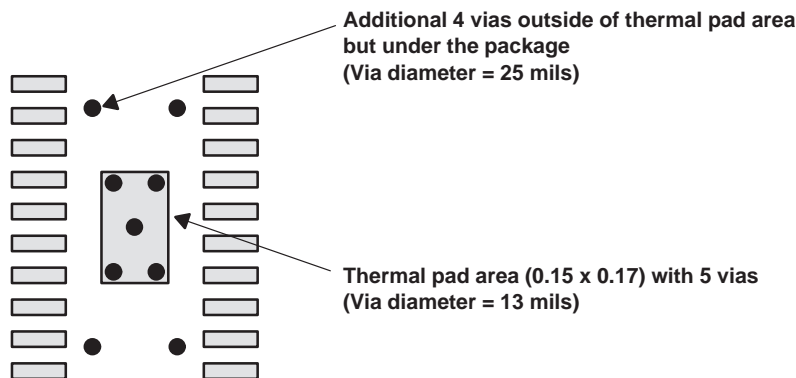

**Figure 57. PowerPad PCB Etch and Via Pattern**

The actual thermal performance achieved with the THS6002 in its PowerPAD package depends on the application. In the previous example, if the size of the internal ground plane is approximately 3 inches x 3 inches, then the expected thermal coefficient,  $\theta_{JA}$ , is about 21.5°C/W. For a given  $\theta_{JA}$ , the maximum power dissipation is shown in Figure 58 and is calculated by the following formula:

$$P_D = \left( \frac{T_{MAX} - T_A}{\theta_{JA}} \right)$$

Where:

- $P_D$  = Maximum power dissipation of THS6002 (watts)
- $T_{MAX}$  = Absolute maximum junction temperature (150°C)
- $T_A$  = Free-ambient air temperature (°C)
- $\theta_{JA}$  =  $\theta_{JC} + \theta_{CA}$
- $\theta_{JC}$  = Thermal coefficient from junction to case (0.37°C/W)
- $\theta_{CA}$  = Thermal coefficient from case to ambient

More complete details of the PowerPAD installation process and thermal management techniques can be found in the Texas Instruments Technical Brief, *PowerPAD Thermally Enhanced Package*. This document can be found at the TI web site ([www.ti.com](http://www.ti.com)) by searching on the key word PowerPAD. The document can also be ordered through your local TI sales office. Refer to literature number SLMA002 when ordering.



APPLICATION INFORMATION

PCB design considerations (continued)

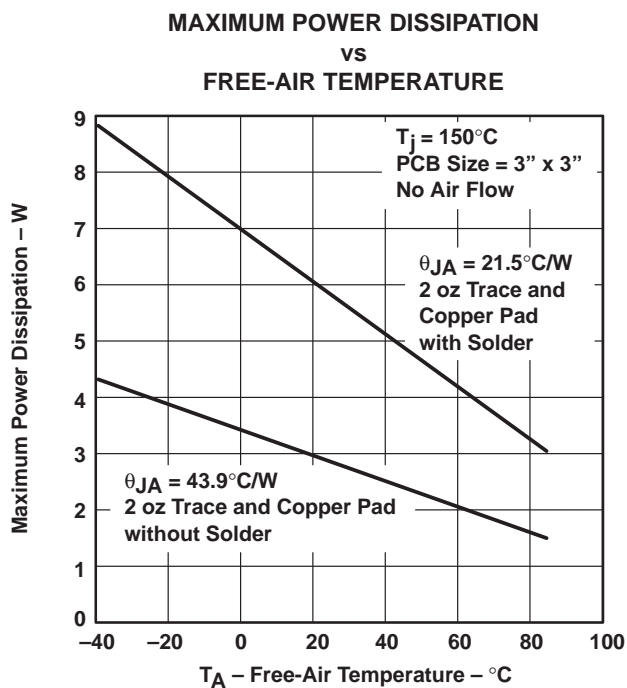

Figure 58. Maximum Power Dissipation vs Free-Air Temperature

# THS6002 DUAL DIFFERENTIAL LINE DRIVERS AND RECEIVERS

SLOS202D— JANUARY 1998— REVISED JULY 1999

## APPLICATION INFORMATION

### ADSL

The THS6002 was primarily designed as a line driver and line receiver for ADSL (asymmetrical digital subscriber line). The driver output stage has been sized to provide full ADSL power levels of 20 dBm onto the telephone lines. Although actual driver output peak voltages and currents vary with each particular ADSL application, the THS6002 is specified for a minimum full output current of 400 mA at its full output voltage of approximately 12 V. This performance meets the demanding needs of ADSL at the central office end of the telephone line. A typical ADSL schematic is shown in Figure 59.

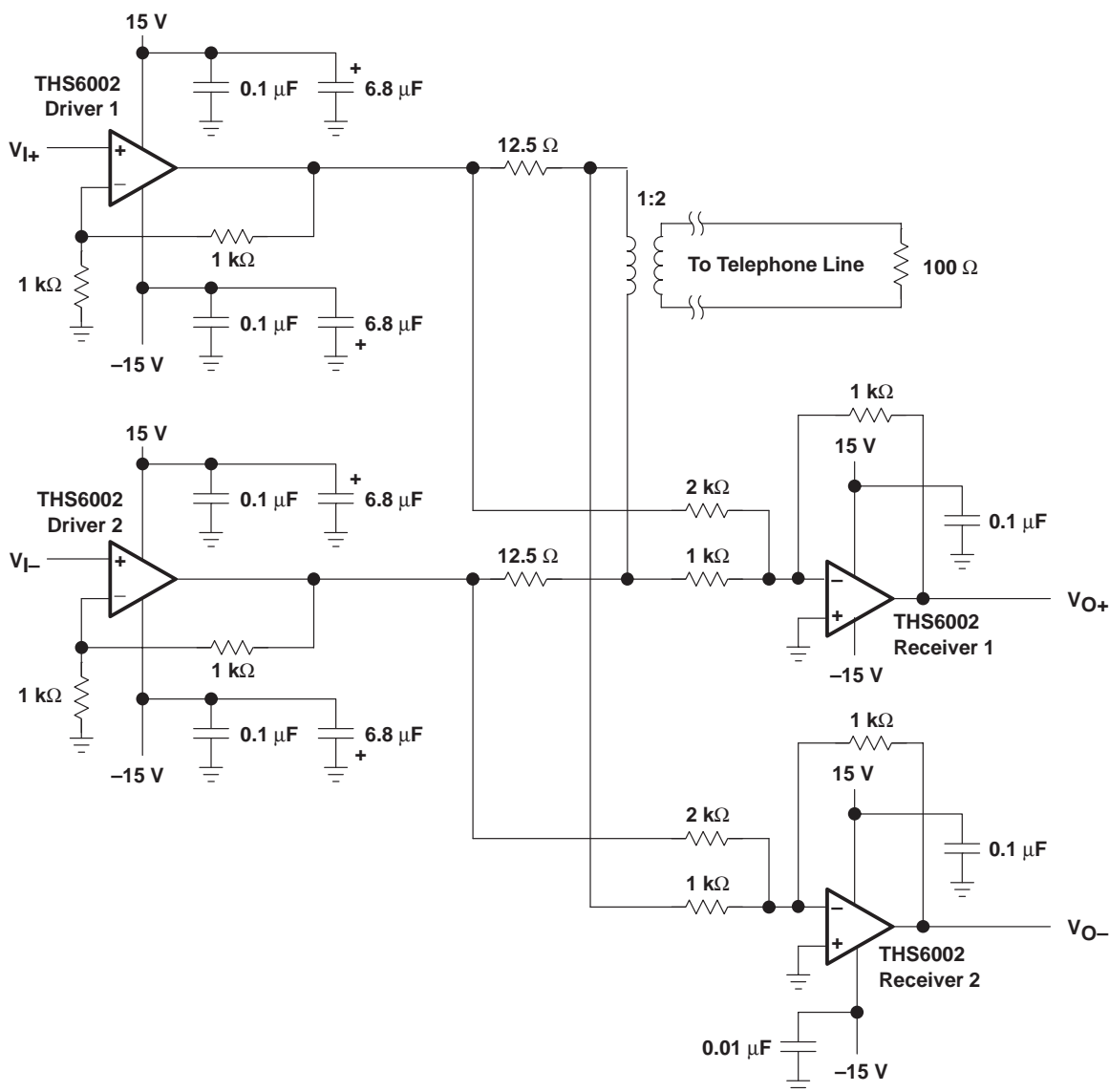

Figure 59. THS6002 ADSL Application

---

## APPLICATION INFORMATION

### ADSL (continued)

The ADSL transmit band consists of 255 separate carrier frequencies each with its own modulation and amplitude level. With such an implementation, it is imperative that signals put onto the telephone line have as low a distortion as possible. This is because any distortion either interferes directly with other ADSL carrier frequencies or it creates intermodulation products that interfere with ADSL carrier frequencies.

The THS6002 has been specifically designed for ultra low distortion by careful circuit implementation and by taking advantage of the superb characteristics of the complementary bipolar process. Driver single-ended distortion measurements are shown in Figure 23. It is commonly known that in the differential driver configuration, the second order harmonics tend to cancel out. Thus, the dominant total harmonic distortion (THD) will be primarily due to the third order harmonics. For this test, the load was  $25\ \Omega$  and the output signal produced a  $20\ V_{O(PP)}$  signal. Thus, the test was run at full signal and full load conditions. Because the feedback resistor used for the test was  $4\ k\Omega$ , the distortion numbers are actually in a worst-case scenario. Distortion should be reduced as the feedback resistance drops. This is because the bandwidth of the amplifier increases dramatically, which allows the amplifier to react faster to any nonlinearities in the closed-loop system.

Another significant point is the fact that distortion decreases as the impedance load increases. This is because the output resistance of the amplifier becomes less significant as compared to the output load resistance.

# THS6002 DUAL DIFFERENTIAL LINE DRIVERS AND RECEIVERS

SLOS202D– JANUARY 1998– REVISED JULY 1999

## APPLICATION INFORMATION

### HDSL

Shown in Figure 60 is an example of the THS6002 being used for HDSL-2 applications. The receiver amplifiers within the THS6002 have been configured as predrivers for the driver amplifiers. This dual composite amplifier setup has the effect of raising the open loop gain for the combination of both amplifiers, thereby giving improved distortion performance.

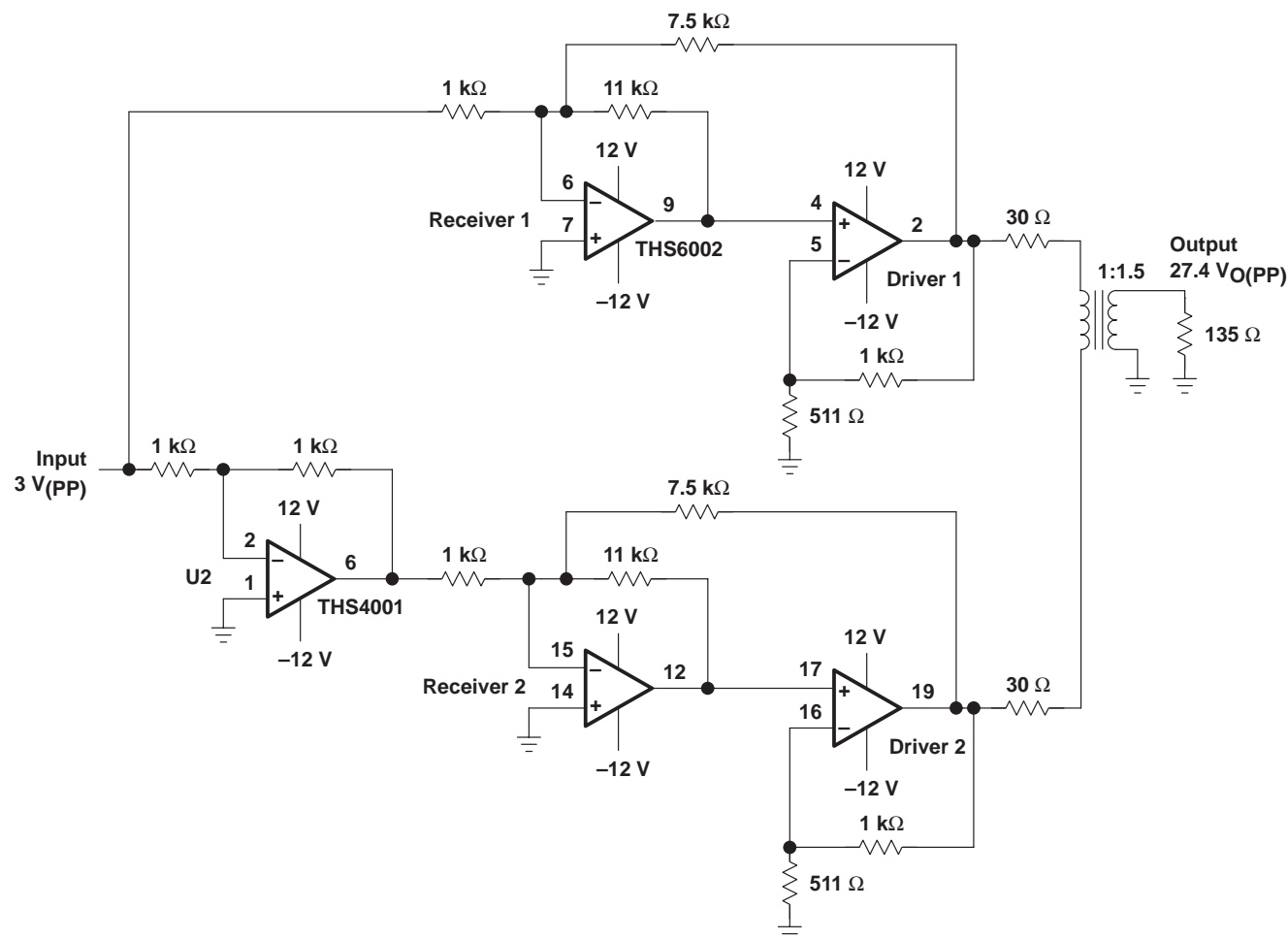

Figure 60. HDSL-2 Line Driver

### general configurations

A common error for the first-time CFB user is to create a unity gain buffer amplifier by shorting the output directly to the inverting input. A CFB amplifier in this configuration is now commonly referred to as an oscillator. The THS6002, like all CFB amplifiers, **must** have a feedback resistor for stable operation. Additionally, placing capacitors directly from the output to the inverting input is not recommended. This is because, at high frequencies, a capacitor has a very low impedance. This results in an unstable amplifier and should not be considered when using a current-feedback amplifier. Because of this, integrators and simple low-pass filters, which are easily implemented on a VFB amplifier, have to be designed slightly differently. If filtering is required, simply place an RC-filter at the noninverting terminal of the operational-amplifier (see Figure 61).

APPLICATION INFORMATION

general configurations (continued)

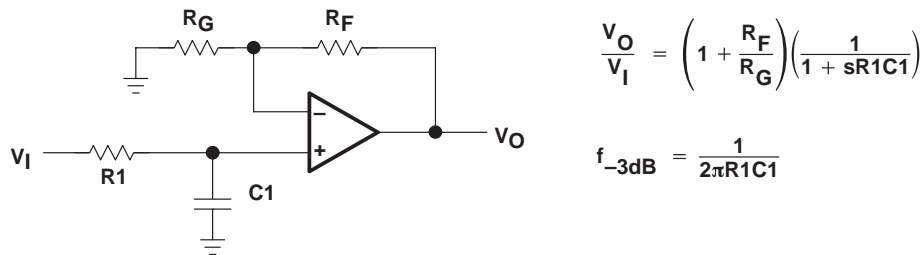

Figure 61. Single-Pole Low-Pass Filter

If a multiple pole filter is required, the use of a Sallen-Key filter can work very well with CFB amplifiers. This is because the filtering elements are not in the negative feedback loop and stability is not compromised. Because of their high slew-rates and high bandwidths, CFB amplifiers can create very accurate signals and help minimize distortion. An example is shown in Figure 62.

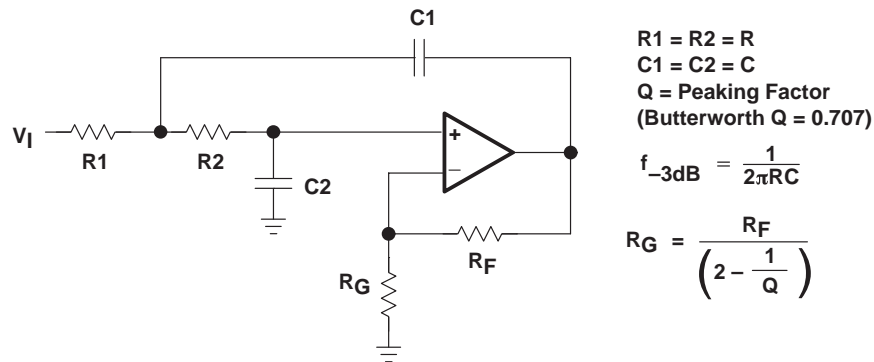

Figure 62. 2-Pole Low-Pass Sallen-Key Filter

There are two simple ways to create an integrator with a CFB amplifier. The first one shown in Figure 63 adds a resistor in series with the capacitor. This is acceptable because at high frequencies, the resistor is dominant and the feedback impedance never drops below the resistor value. The second one shown in Figure 64 uses positive feedback to create the integration. Caution is advised because oscillations can occur because of the positive feedback.

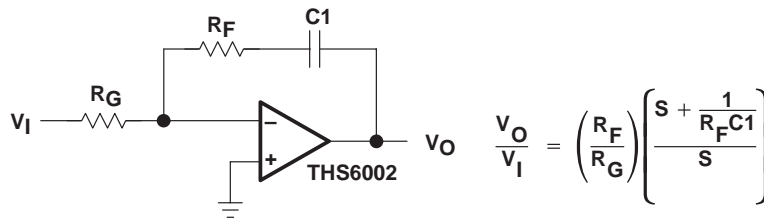

Figure 63. Inverting CFB Integrator

# THS6002 DUAL DIFFERENTIAL LINE DRIVERS AND RECEIVERS

SLOS202D– JANUARY 1998– REVISED JULY 1999

## APPLICATION INFORMATION

### general configurations (continued)

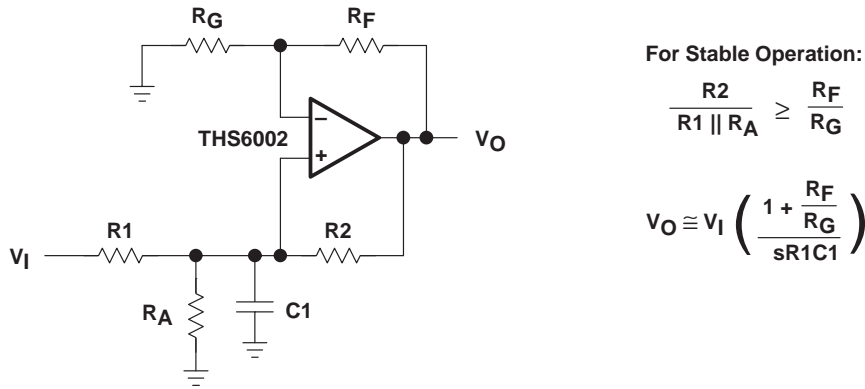

Figure 64. Non-Inverting CFB Integrator

Another good use for the THS6002 driver amplifiers are as very good video distribution amplifiers. One characteristic of distribution amplifiers is the fact that the differential phase (DP) and the differential gain (DG) are compromised as the number of lines increases and the closed-loop gain increases. Be sure to use termination resistors throughout the distribution system to minimize reflections and capacitive loading.

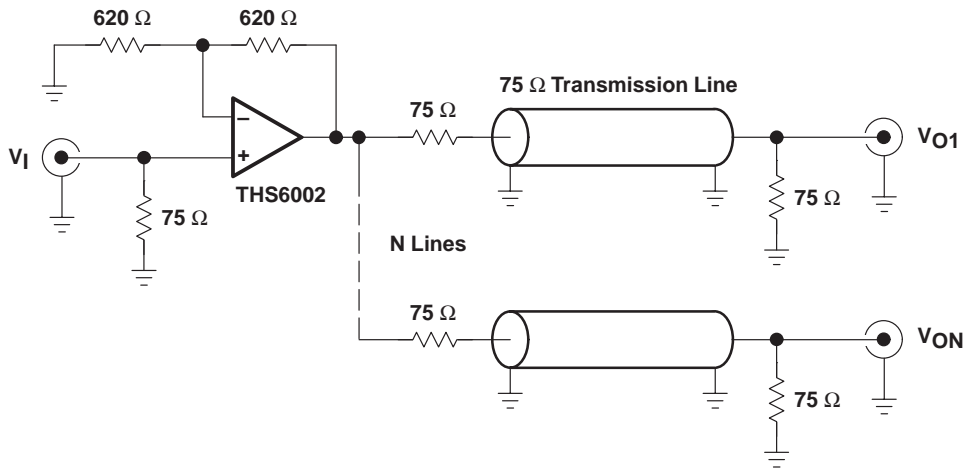

Figure 65. Video Distribution Amplifier Application

### evaluation board

An evaluation board is available for the THS6002 (literature number SLOP117). This board has been configured for proper thermal management of the THS6002. The circuitry has been designed for a typical ADSL application as shown previously in this document. For more detailed information, refer to the *THS6002EVM User's Manual* (literature number SLOU018). To order the evaluation board contact your local TI sales office or distributor.

# THS6002 DUAL DIFFERENTIAL LINE DRIVERS AND RECEIVERS

SLOS202D—JANUARY 1998—REVISED JULY 1999

## MECHANICAL INFORMATION

**DWP (R-PDSO-G20)**

**PowerPAD™ PLASTIC SMALL-OUTLINE PACKAGE**

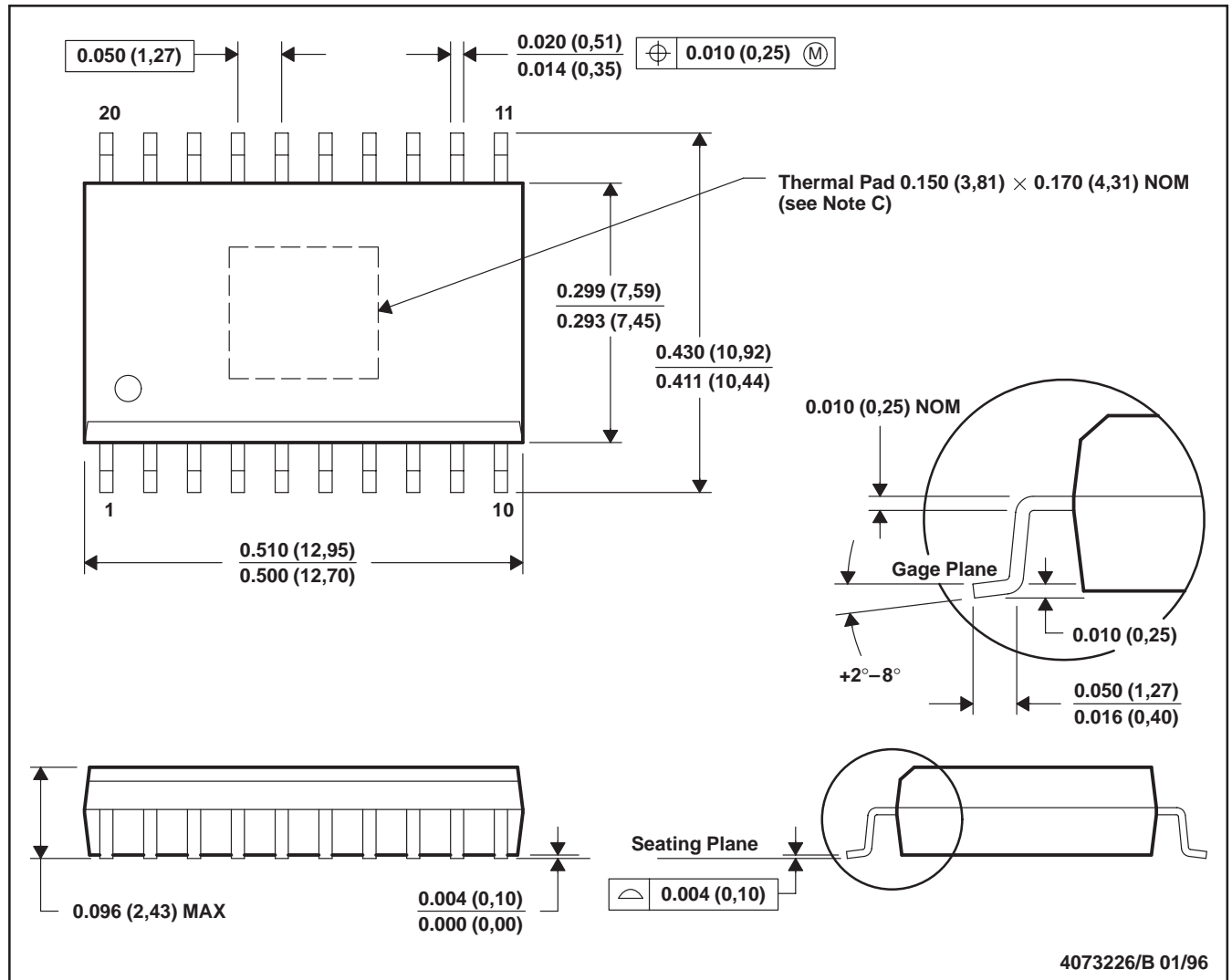

- NOTES: A. All linear dimensions are in inches (millimeters).  
 B. This drawing is subject to change without notice.  
 C. The thermal performance may be enhanced by bonding the thermal pad to an external thermal plane.

PowerPAD is a trademark of Texas Instruments Incorporated.



POST OFFICE BOX 655303 • DALLAS, TEXAS 75265

## **IMPORTANT NOTICE**

Texas Instruments and its subsidiaries (TI) reserve the right to make changes to their products or to discontinue any product or service without notice, and advise customers to obtain the latest version of relevant information to verify, before placing orders, that information being relied on is current and complete. All products are sold subject to the terms and conditions of sale supplied at the time of order acknowledgement, including those pertaining to warranty, patent infringement, and limitation of liability.

TI warrants performance of its semiconductor products to the specifications applicable at the time of sale in accordance with TI's standard warranty. Testing and other quality control techniques are utilized to the extent TI deems necessary to support this warranty. Specific testing of all parameters of each device is not necessarily performed, except those mandated by government requirements.

**CERTAIN APPLICATIONS USING SEMICONDUCTOR PRODUCTS MAY INVOLVE POTENTIAL RISKS OF DEATH, PERSONAL INJURY, OR SEVERE PROPERTY OR ENVIRONMENTAL DAMAGE ("CRITICAL APPLICATIONS"). TI SEMICONDUCTOR PRODUCTS ARE NOT DESIGNED, AUTHORIZED, OR WARRANTED TO BE SUITABLE FOR USE IN LIFE-SUPPORT DEVICES OR SYSTEMS OR OTHER CRITICAL APPLICATIONS. INCLUSION OF TI PRODUCTS IN SUCH APPLICATIONS IS UNDERSTOOD TO BE FULLY AT THE CUSTOMER'S RISK.**

In order to minimize risks associated with the customer's applications, adequate design and operating safeguards must be provided by the customer to minimize inherent or procedural hazards.

TI assumes no liability for applications assistance or customer product design. TI does not warrant or represent that any license, either express or implied, is granted under any patent right, copyright, mask work right, or other intellectual property right of TI covering or relating to any combination, machine, or process in which such semiconductor products or services might be or are used. TI's publication of information regarding any third party's products or services does not constitute TI's approval, warranty or endorsement thereof.



Copyright © Each Manufacturing Company.

All Datasheets cannot be modified without permission.

This datasheet has been download from :

[www.AllDataSheet.com](http://www.AllDataSheet.com)

100% Free DataSheet Search Site.

Free Download.

No Register.

Fast Search System.

[www.AllDataSheet.com](http://www.AllDataSheet.com)