

- 50-mA Low-Dropout Regulator
- Fixed Output Voltage Options: 5 V, 3.8 V, 3.3 V, 3.2 V, and 3 V
- Dropout Typically 120 mV at 50 mA
- Thermal Protection
- Less Than 1  $\mu$ A Quiescent Current in Shutdown
- $-40^{\circ}\text{C}$  to  $125^{\circ}\text{C}$  Operating Junction Temperature Range
- 5-Pin SOT-23 Package
- ESD Protection Verified to 1.5 kV Human Body Model (HBM) per MIL-STD-883C

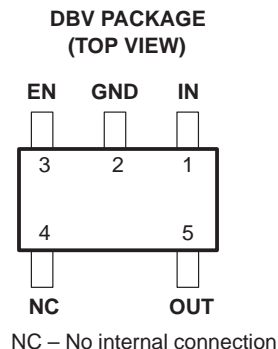

### description

The TPS760xx is a 50mA, low dropout (LDO) voltage regulator designed specifically for battery-powered applications. A proprietary BiCMOS fabrication process allows the TPS760xx to provide outstanding performance in all specifications critical to battery-powered operation.

The TPS760xx is available in a space-saving SOT-23 package and operates over a junction temperature range of  $-40^{\circ}\text{C}$  to  $125^{\circ}\text{C}$ .

AVAILABLE OPTIONS

| $T_J$  | VOLTAGE | PACKAGE | PART NUMBER  | SYMBOL |
|--|---------|---------|--------------|--------|
| $-40^{\circ}\text{C}$ to $125^{\circ}\text{C}$ | 3 V     | SOT-23  | TPS76030DBVR | PAGI   |
|  | 3.2 V   |         | TPS76032DBVR | PAOI   |
|  | 3.3 V   |         | TPS76033DBVR | PAHI   |
|  | 3.8 V   |         | TPS76038DBVR | PAJI   |
|  | 5 V     |         | TPS76050DBVR | PANI   |

NOTE: The DBV package is available taped and reeled only.

### functional block diagram

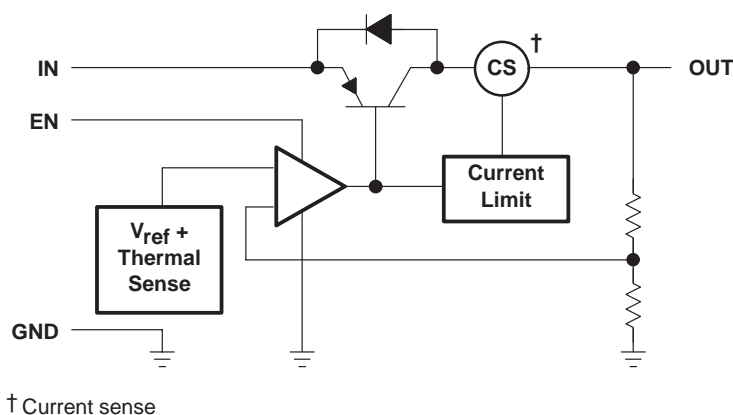

Please be aware that an important notice concerning availability, standard warranty, and use in critical applications of Texas Instruments semiconductor products and disclaimers thereto appears at the end of this data sheet.

# TPS76030, TPS76032, TPS76033, TPS76038, TPS76050

## LOW-POWER 50-mA LOW-DROPOUT LINEAR REGULATORS

SLVS144B –JULY 1998 – REVISED FEBRUARY 1999

### Terminal Functions

| TERMINAL NAME | NO. | I/O | DESCRIPTION              |
|---------------|-----|-----|--------------------------|
| IN            | 1   | I   | Input voltage            |
| GND           | 2   |     | Ground                   |
| EN            | 3   | I   | Enable input             |
| NC            | 4   |     | No connection            |
| OUT           | 5   | O   | Regulated output voltage |

### absolute maximum ratings over operating free-air temperature range (unless otherwise noted)†

|   |                         |
|---|-------------------------|
| Input voltage range, $V_I$ ‡                | –0.3 V to 16 V          |
| Voltage range at EN                         | –0.3 V to $V_I + 0.3$ V |
| Peak output current                         | internally limited      |
| Continuous total dissipation                | See dissipation table   |
| Operating junction temperature range, $T_J$ | –40°C to 150°C          |
| Storage temperature range, $T_{stg}$        | –65°C to 150°C          |
| ESD rating, HBM                             | 1.5 kV                  |

† Stresses beyond those listed under “absolute maximum ratings” may cause permanent damage to the device. These are stress ratings only, and functional operation of the device at these or any other conditions beyond those indicated under “recommended operating conditions” is not implied. Exposure to absolute-maximum-rated conditions for extended periods may affect device reliability.

‡ All voltages are with respect to device GND pin.

DISSIPATION RATING TABLE

|             | PACKAGE | $T_A \leq 25^\circ\text{C}$<br>POWER RATING | DERATING FACTOR<br>ABOVE $T_A = 25^\circ\text{C}$ | $T_A = 70^\circ\text{C}$<br>POWER RATING | $T_A = 85^\circ\text{C}$<br>POWER RATING |
|-------------|---------|---|---|--|--|
| Recommended | DBV     | 350 mW                                      | 3.5 mW/°C   | 192 mW                                   | 140 mW                                   |
| Maximum     | DBV     | 437 mW                                      | 3.5 mW/°C   | 280 mW                                   | 227 mW                                   |

### recommended operating conditions

|                                       |          | MIN | NOM | MAX | UNIT |
|---------------------------------------|----------|-----|-----|-----|------|
| Input voltage, $V_I$                  | TPS76030 | 3.2 |     | 16  | V    |
|                                       | TPS76032 | 3.4 |     | 16  | V    |
|                                       | TPS76033 | 3.5 |     | 16  | V    |
|                                       | TPS76038 | 4   |     | 16  | V    |
|                                       | TPS76050 | 5.2 |     | 16  | V    |
| Continuous output current, $I_O$      |          | 0   |     | 50  | mA   |
| Operating junction temperature, $T_J$ |          | –40 |     | 125 | °C   |



# TPS76030, TPS76032, TPS76033, TPS76038, TPS76050 LOW-POWER 50-mA LOW-DROPOUT LINEAR REGULATORS

SLVS144B –JULY 1998 – REVISED FEBRUARY 1999

**electrical characteristics over recommended operating free-air temperature range,  
 $V_I = V_{O(nom)} + 1\text{ V}$ ,  $I_O = 1\text{ mA}$ ,  $EN = V_I$ ,  $C_O = 2.2\text{ }\mu\text{F}$  (unless otherwise noted)**

| PARAMETER                       |                                   | TEST CONDITIONS   | MIN                      | TYP  | MAX  | UNIT             |   |
|---------------------------------|-----------------------------------|---|--------------------------|------|------|------------------|---|
| $V_O$                           | Output voltage                    | TPS76030  | $T_J = 25^\circ\text{C}$ | 2.96 | 3    | 3.04             | V |
|                                 |                                   | $T_J = 25^\circ\text{C}$ , $1\text{ mA} < I_O < 50\text{ mA}$                                     | 2.92                     |      | 3.04 | V                |   |
|                                 |                                   | $1\text{ mA} < I_O < 50\text{ mA}$  | 2.91                     |      | 3.07 | V                |   |
|                                 | Output voltage                    | TPS76032  | $T_J = 25^\circ\text{C}$ | 3.16 | 3.2  | 3.24             | V |
|                                 |                                   | $T_J = 25^\circ\text{C}$ , $1\text{ mA} < I_O < 50\text{ mA}$                                     | 3.13                     |      | 3.24 | V                |   |
|                                 |                                   | $1\text{ mA} < I_O < 50\text{ mA}$  | 3.1                      |      | 3.3  | V                |   |
|                                 | Output voltage                    | TPS76033  | $T_J = 25^\circ\text{C}$ | 3.26 | 3.3  | 3.34             | V |
|                                 |                                   | $T_J = 25^\circ\text{C}$ , $1\text{ mA} < I_O < 50\text{ mA}$                                     | 3.23                     |      | 3.34 | V                |   |
|                                 |                                   | $1\text{ mA} < I_O < 50\text{ mA}$  | 3.2                      |      | 3.4  | V                |   |
|                                 | Output voltage                    | TPS76038  | $T_J = 25^\circ\text{C}$ | 3.76 | 3.8  | 3.84             | V |
|                                 |                                   | $T_J = 25^\circ\text{C}$ , $1\text{ mA} < I_O < 50\text{ mA}$                                     | 3.73                     |      | 3.84 | V                |   |
|                                 |                                   | $1\text{ mA} < I_O < 50\text{ mA}$  | 3.7                      |      | 3.9  | V                |   |
|                                 | Output voltage                    | TPS76050  | $T_J = 25^\circ\text{C}$ | 4.95 | 5    | 5.05             | V |
|                                 |                                   | $T_J = 25^\circ\text{C}$ , $1\text{ mA} < I_O < 50\text{ mA}$                                     | 4.91                     |      | 5.05 | V                |   |
|                                 |                                   | $1\text{ mA} < I_O < 50\text{ mA}$  | 4.89                     |      | 5.1  | V                |   |
| $I_{I(\text{standby})}$         | Standby current                   | $EN = 0\text{ V}$   |                          |      | 1    | $\mu\text{A}$    |   |
| Quiescent current (GND current) |                                   | $I_O = 0\text{ mA}$ , $T_J = 25^\circ\text{C}$  |                          | 90   | 115  | $\mu\text{A}$    |   |
|                                 |                                   | $I_O = 0\text{ mA}$   |                          |      | 130  |                  |   |
|                                 |                                   | $I_O = 1\text{ mA}$ , $T_J = 25^\circ\text{C}$  |                          | 100  | 130  |                  |   |
|                                 |                                   | $I_O = 1\text{ mA}$   |                          |      | 170  |                  |   |
|                                 |                                   | $I_O = 10\text{ mA}$ , $T_J = 25^\circ\text{C}$   |                          | 190  | 215  |                  |   |
|                                 |                                   | $I_O = 10\text{ mA}$  |                          |      | 460  |                  |   |
|                                 |                                   | $I_O = 50\text{ mA}$ , $T_J = 25^\circ\text{C}$   |                          | 850  | 1100 |                  |   |
|                                 |                                   | $I_O = 50\text{ mA}$  |                          |      | 1200 |                  |   |
| Input regulation                | TPS76030                          | $4\text{ V} < V_I < 16$ , $I_O = 1\text{ mA}$   |                          | 3    | 10   | mV               |   |
|                                 | TPS76032                          | $4.2\text{ V} < V_I < 16$ , $I_O = 1\text{ mA}$   |                          | 3    | 10   |                  |   |
|                                 | TPS76033                          | $4.3\text{ V} < V_I < 16$ , $I_O = 1\text{ mA}$   |                          | 3    | 10   |                  |   |
|                                 | TPS76038                          | $4.8\text{ V} < V_I < 16$ , $I_O = 1\text{ mA}$   |                          | 3    | 10   |                  |   |
|                                 | TPS76050                          | $6\text{ V} < V_I < 16$ , $I_O = 1\text{ mA}$   |                          | 3    | 10   |                  |   |
| $V_n$                           | Output noise voltage              | $BW = 300\text{ Hz to } 50\text{ kHz}$ , $C_O = 10\text{ }\mu\text{F}$ , $T_J = 25^\circ\text{C}$ |                          | 190  |      | $\mu\text{Vrms}$ |   |
|                                 | Ripple rejection                  | $f = 1\text{ kHz}$ , $C_O = 10\text{ }\mu\text{F}$ , $T_J = 25^\circ\text{C}$                     |                          | 63   |      | dB               |   |
| Dropout voltage                 |                                   | $I_O = 0\text{ mA}$ , $T_J = 25^\circ\text{C}$  |                          | 1    | 3    | mV               |   |
|                                 |                                   | $I_O = 0\text{ mA}$   |                          |      | 5    |                  |   |
|                                 |                                   | $I_O = 1\text{ mA}$ , $T_J = 25^\circ\text{C}$  |                          | 7    | 10   |                  |   |
|                                 |                                   | $I_O = 1\text{ mA}$   |                          |      | 15   |                  |   |
|                                 |                                   | $I_O = 10\text{ mA}$ , $T_J = 25^\circ\text{C}$   |                          | 40   | 60   |                  |   |
|                                 |                                   | $I_O = 10\text{ mA}$  |                          |      | 90   |                  |   |
|                                 |                                   | $I_O = 50\text{ mA}$ , $T_J = 25^\circ\text{C}$   |                          | 120  | 150  |                  |   |
|                                 |                                   |   |                          | 180  |      |                  |   |
|                                 | Peak output current/current limit | $T_J = 25^\circ\text{C}$  | 100                      | 125  |      | mA               |   |



**TPS76030, TPS76032, TPS76033, TPS76038, TPS76050**  
**LOW-POWER 50-mA LOW-DROPOUT LINEAR REGULATORS**

SLVS144B –JULY 1998 – REVISED FEBRUARY 1999

**electrical characteristics over recommended operating free-air temperature range,  
 $V_I = V_{O(nom)} + 1\text{ V}$ ,  $I_O = 1\text{ mA}$ ,  $EN = V_I$ ,  $C_O = 1\text{ }\mu\text{F}$  (unless otherwise noted) (continued)**

| PARAMETER |                         | TEST CONDITIONS   | MIN | TYP | MAX | UNIT          |
|-----------|-------------------------|-------------------|-----|-----|-----|---------------|
|           | High level enable input |                   | 2   |     |     | V             |
|           | Low level enable input  |                   |     |     | 0.8 | V             |
| $I_I$     | Input current (EN)      | $EN = 0\text{ V}$ | -1  | 0   | 1   | $\mu\text{A}$ |
|           |                         | $EN = V_I$        |     | 2.5 | 5   | $\mu\text{A}$ |

**TYPICAL CHARACTERISTICS**

**Table of Graphs**

|          |                         |                         | FIGURE  |
|----------|-------------------------|-------------------------|---------|
| $V_O$    | Output voltage          | vs Output current       | 1, 2, 3 |
|          |                         | vs Free-air temperature | 4, 5, 6 |
|          | Ground current          | vs Free-air temperature | 7, 8, 9 |
|          | Output noise            | vs Frequency            | 10      |
| $Z_o$    | Output impedance        | vs Frequency            | 11      |
| $V_{DO}$ | Dropout voltage         | vs Free-air temperature | 12      |
|          | Line transient response |                         | 13, 15  |
|          | Load transient response |                         | 14, 16  |



TYPICAL CHARACTERISTICS

TPS76030  
 OUTPUT VOLTAGE  
 vs  
 OUTPUT CURRENT

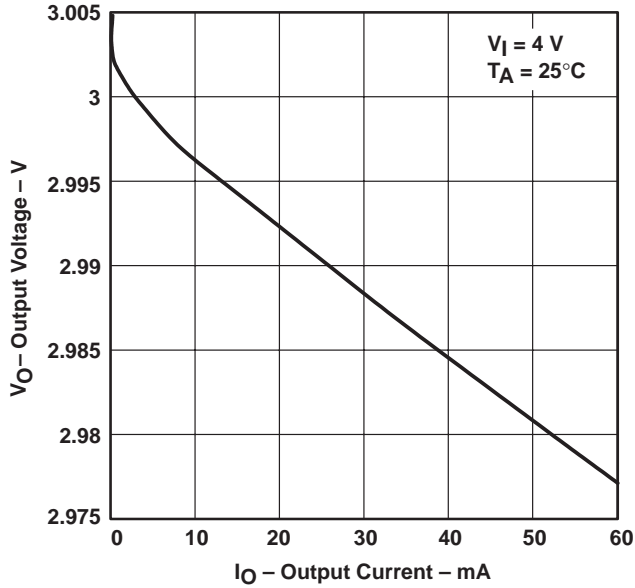

Figure 1

TPS76033  
 OUTPUT VOLTAGE  
 vs  
 OUTPUT CURRENT

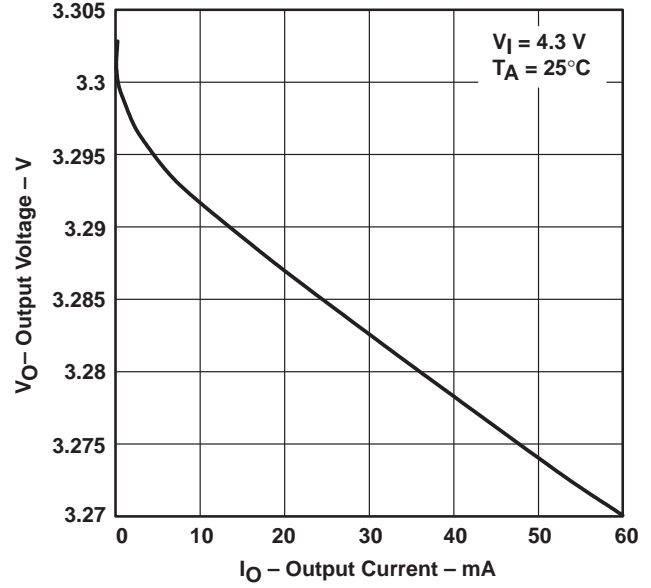

Figure 2

TPS76050  
 OUTPUT VOLTAGE  
 vs  
 OUTPUT CURRENT

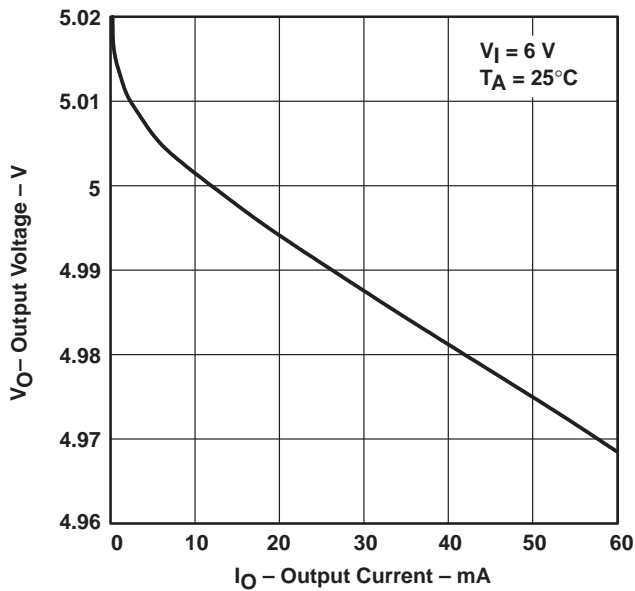

Figure 3

TPS76030  
 OUTPUT VOLTAGE  
 vs  
 FREE-AIR TEMPERATURE

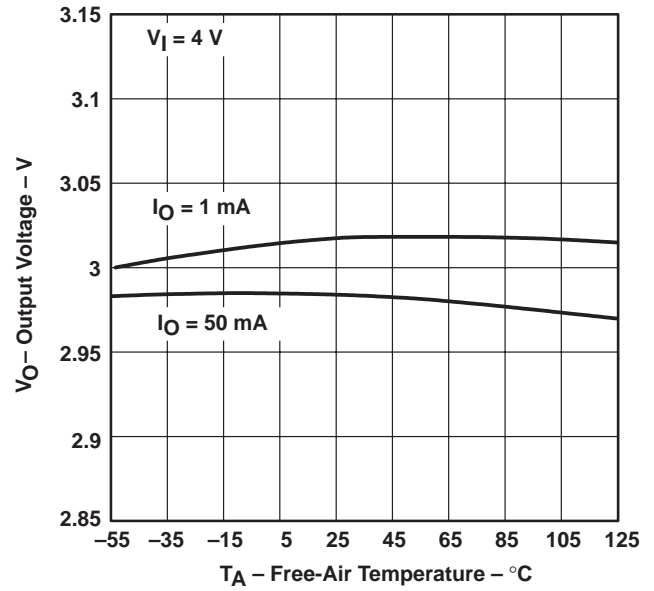

Figure 4

# TPS76030, TPS76032, TPS76033, TPS76038, TPS76050

## LOW-POWER 50-mA LOW-DROPOUT LINEAR REGULATORS

SLVS144B – JULY 1998 – REVISED FEBRUARY 1999

### TYPICAL CHARACTERISTICS

TPS76033  
OUTPUT VOLTAGE  
vs  
FREE-AIR TEMPERATURE

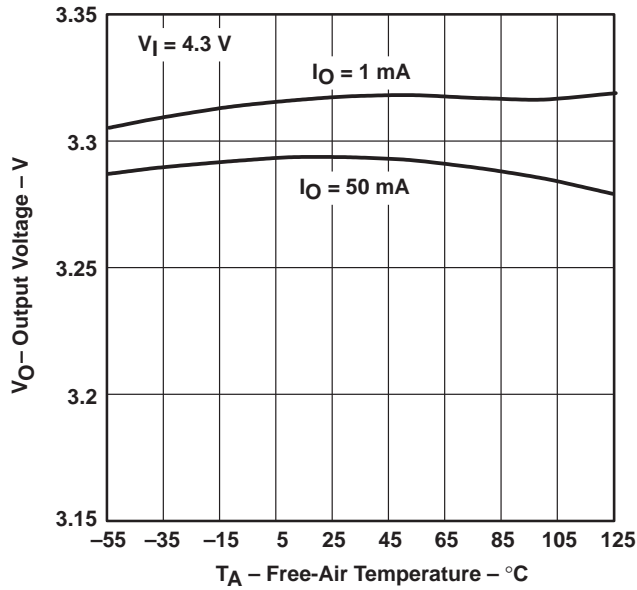

Figure 5

TPS76050  
OUTPUT VOLTAGE  
vs  
FREE-AIR TEMPERATURE

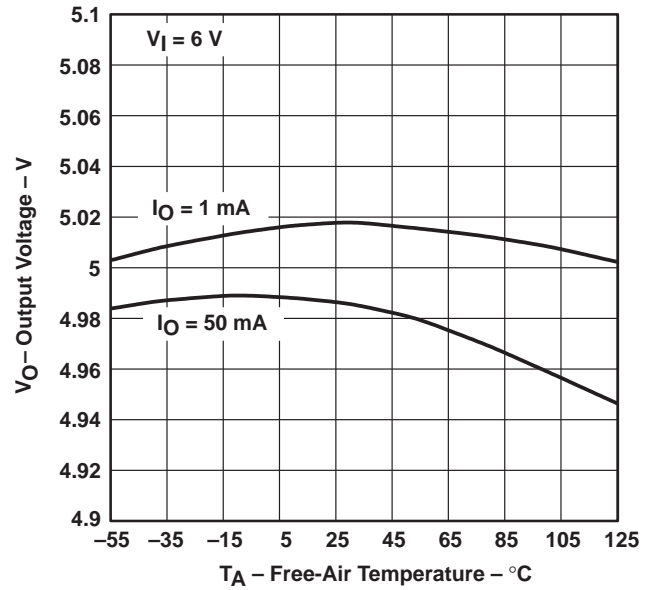

Figure 6

TPS76030  
GROUND CURRENT  
vs  
FREE-AIR TEMPERATURE

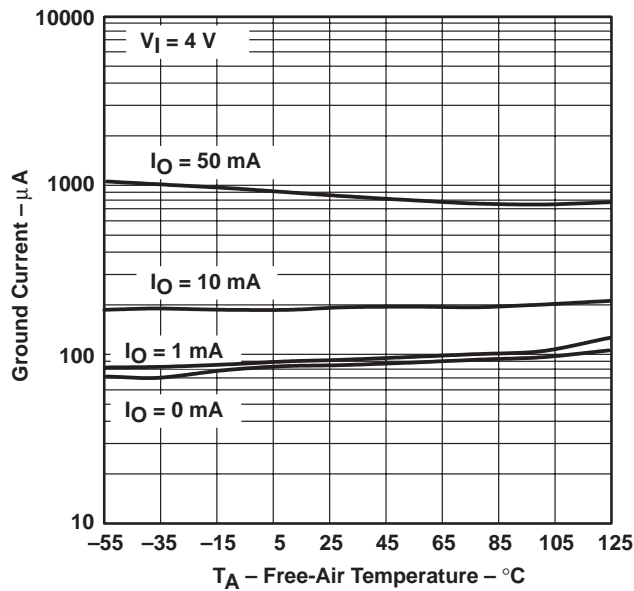

Figure 7

TPS76033  
GROUND CURRENT  
vs  
FREE-AIR TEMPERATURE

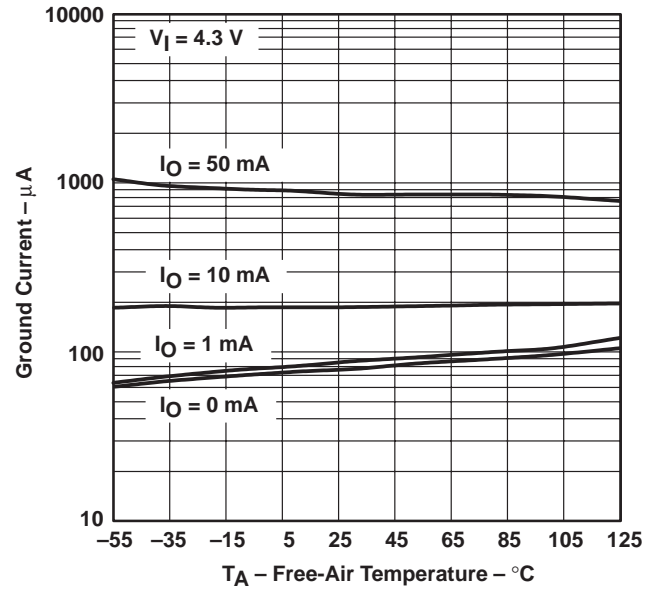
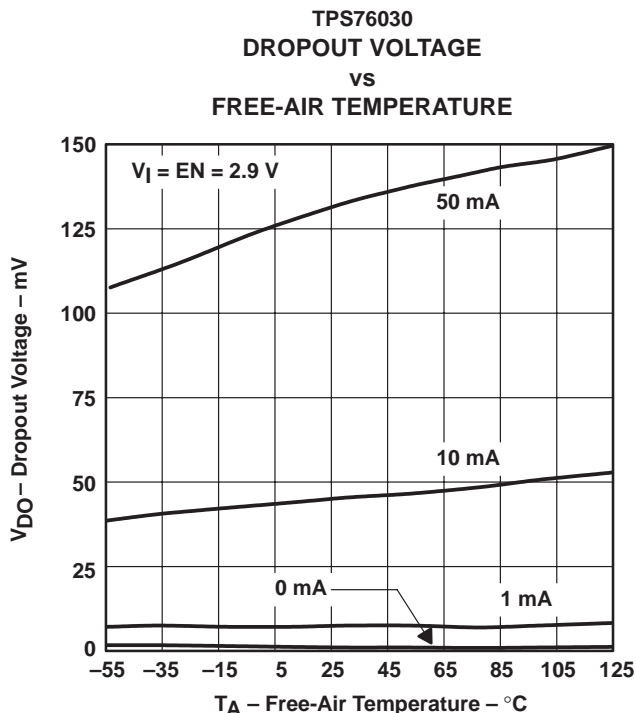
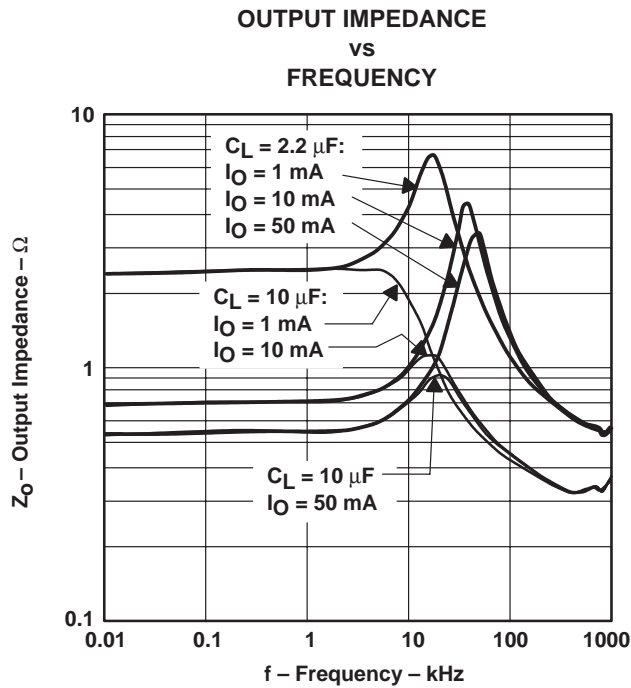
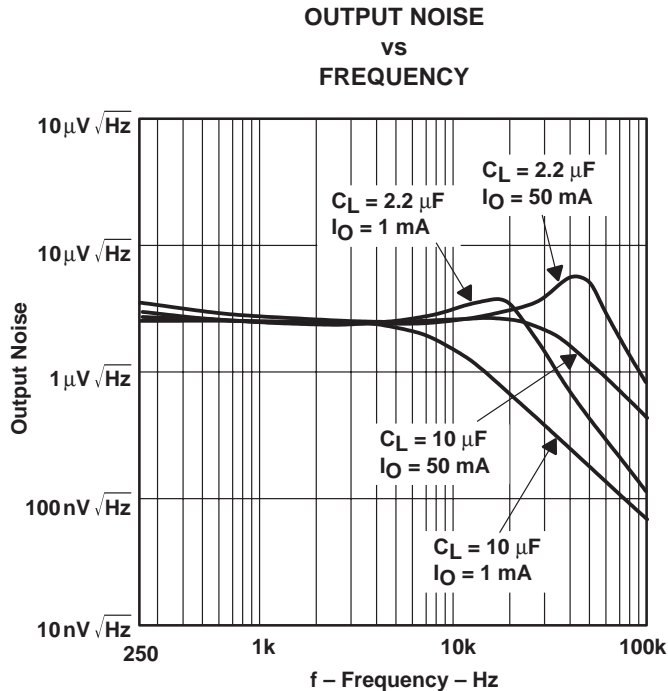
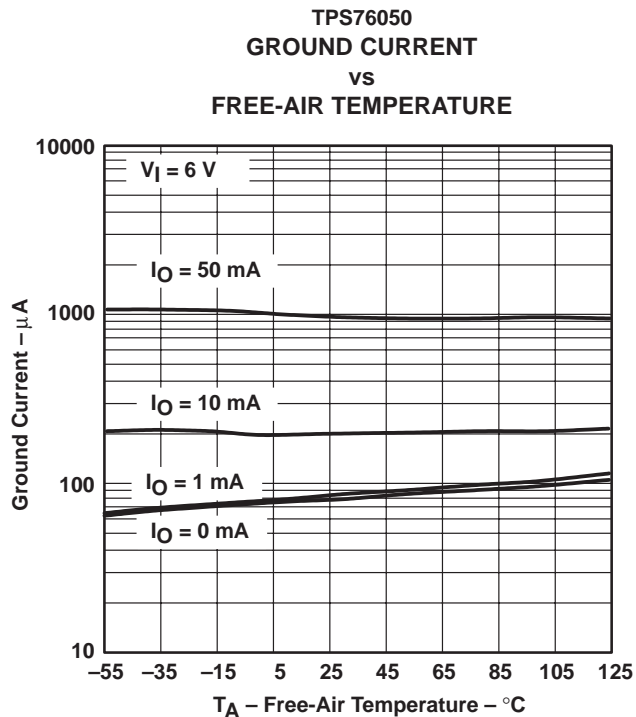

Figure 8



TYPICAL CHARACTERISTICS



# TPS76030, TPS76032, TPS76033, TPS76038, TPS76050

## LOW-POWER 50-mA LOW-DROPOUT LINEAR REGULATORS

SLVS144B – JULY 1998 – REVISED FEBRUARY 1999

### TYPICAL CHARACTERISTICS

**TPS76033**  
**LINE TRANSIENT RESPONSE**

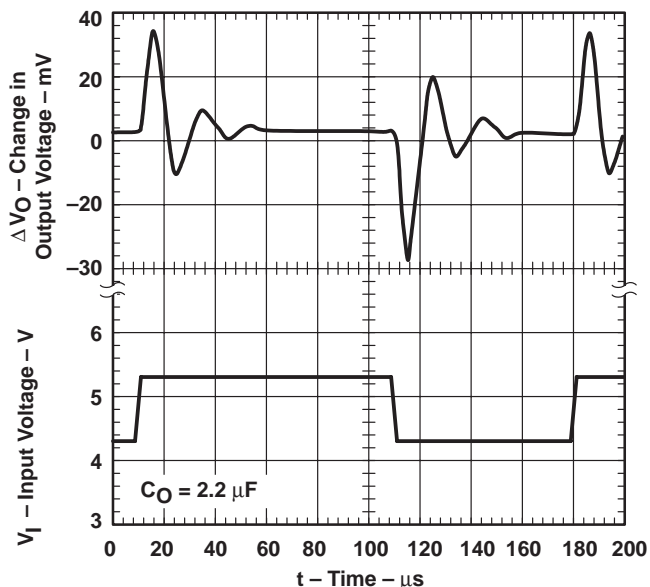

**Figure 13**

**TPS76033**  
**LOAD TRANSIENT RESPONSE**

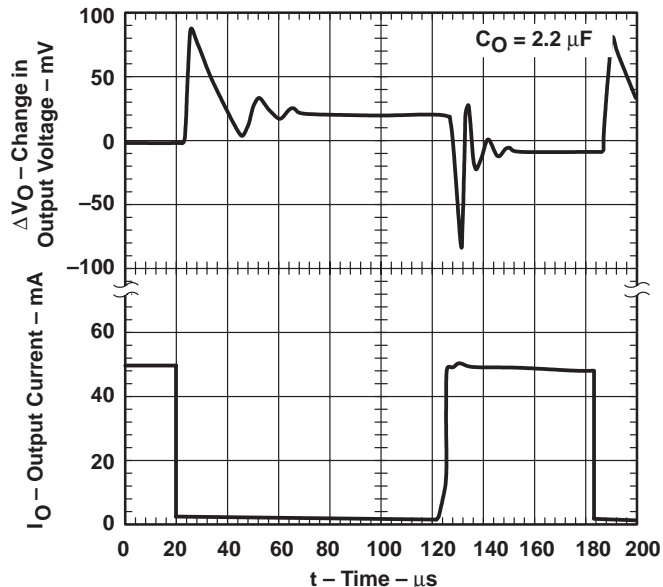

**Figure 14**

**TPS76050**  
**LINE TRANSIENT RESPONSE**

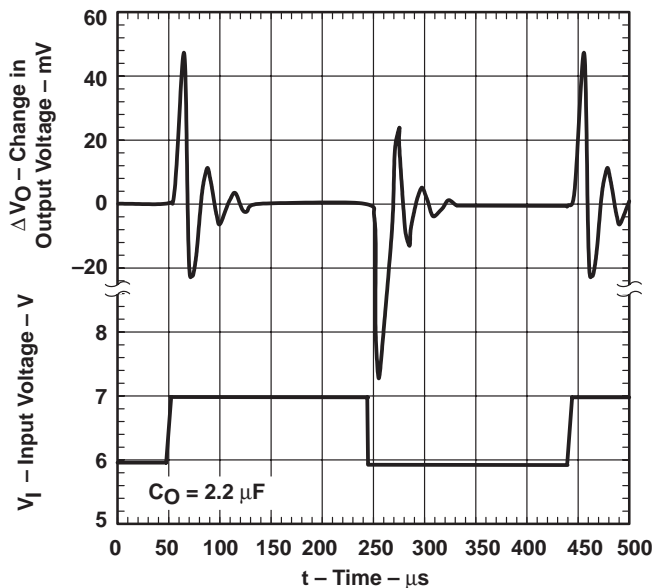

**Figure 15**

**TPS76050**  
**LOAD TRANSIENT RESPONSE**

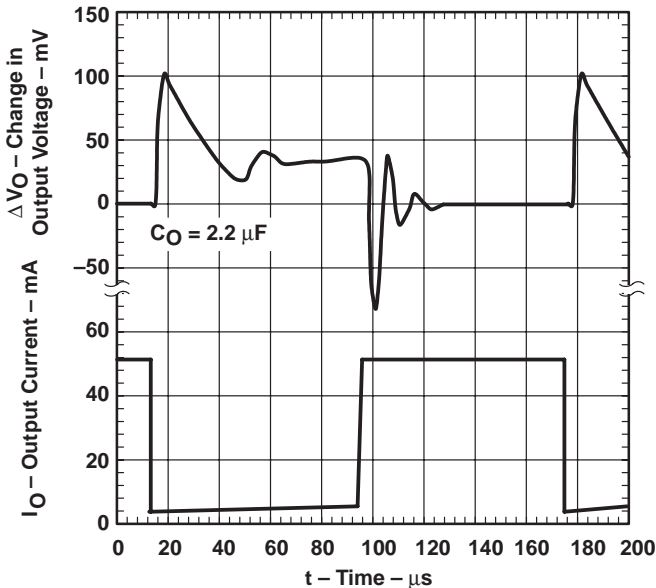

**Figure 16**





## APPLICATION INFORMATION

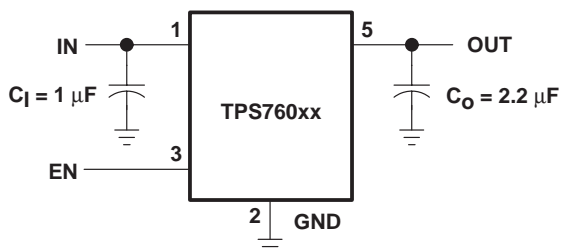

Figure 17. TPS760xx Typical Application

### over current protection

The over current protection circuit forces the TPS760xx into a constant current output mode when the load is excessive or the output is shorted to ground. Normal operation resumes when the fault condition is removed. An overload or short circuit may also activate the over temperature protection if the fault condition persists.

### over temperature protection

The thermal protection system shuts the TPS760xx down when the junction temperature exceeds 160°C. The device recovers and operates normally when the temperature drops below 150°C.

### input capacitor

A 0.047 µF or larger ceramic decoupling capacitor with short leads connected between IN and GND is recommended. The decoupling capacitor may be omitted if there is a 1 µF or larger electrolytic capacitor connected between IN and GND and located reasonably close to the TPS760xx. However, the small ceramic device is desirable even when the larger capacitor is present, if there is a lot of high frequency noise present in the system.

### output capacitor

Like all low dropout regulators, the TPS760xx requires an output capacitor connected between OUT and GND to stabilize the internal control loop. The minimum recommended capacitance value is 2.2 µF and the ESR (equivalent series resistance) must be between 0.1 Ω and 20 Ω. Capacitor values of 2.5-µF or larger are acceptable, provided the ESR is less than 20 Ω. Solid tantalum electrolytic, aluminum electrolytic, and multilayer ceramic capacitors are all suitable, provided they meet the requirements described above. Most of the commercially available 2.2-µF surface-mount solid-tantalum capacitors, including devices from Sprague, Kemet, and Nichicon, meet the ESR requirements stated above. Multilayer ceramic capacitors should have minimum values of 2.5 µF over the full operating temperature range of the equipment.

### enable (EN)

A logic zero on the enable input shuts the TPS760xx off and reduces the supply current to less than 1 µA. Pulling the enable input high causes normal operation to resume. If the enable feature is not used, EN should be connected to IN to keep the regulator on all of the time. The EN input must not be left floating.

# TPS76030, TPS76032, TPS76033, TPS76038, TPS76050 LOW-POWER 50-mA LOW-DROPOUT LINEAR REGULATORS

SLVS144B –JULY 1998 – REVISED FEBRUARY 1999

## APPLICATION INFORMATION

### reverse current path

The power transistor used in the TPS760xx has an inherent diode connected between IN and OUT as shown in the functional block diagram. This diode conducts current from the OUT terminal to the IN terminal whenever IN is lower than OUT by a diode drop. This condition does not damage the TPS760xx, provided the current is limited to 100mA.

## MECHANICAL DATA

DBV (R-PDSO-G5)

PLASTIC SMALL-OUTLINE PACKAGE

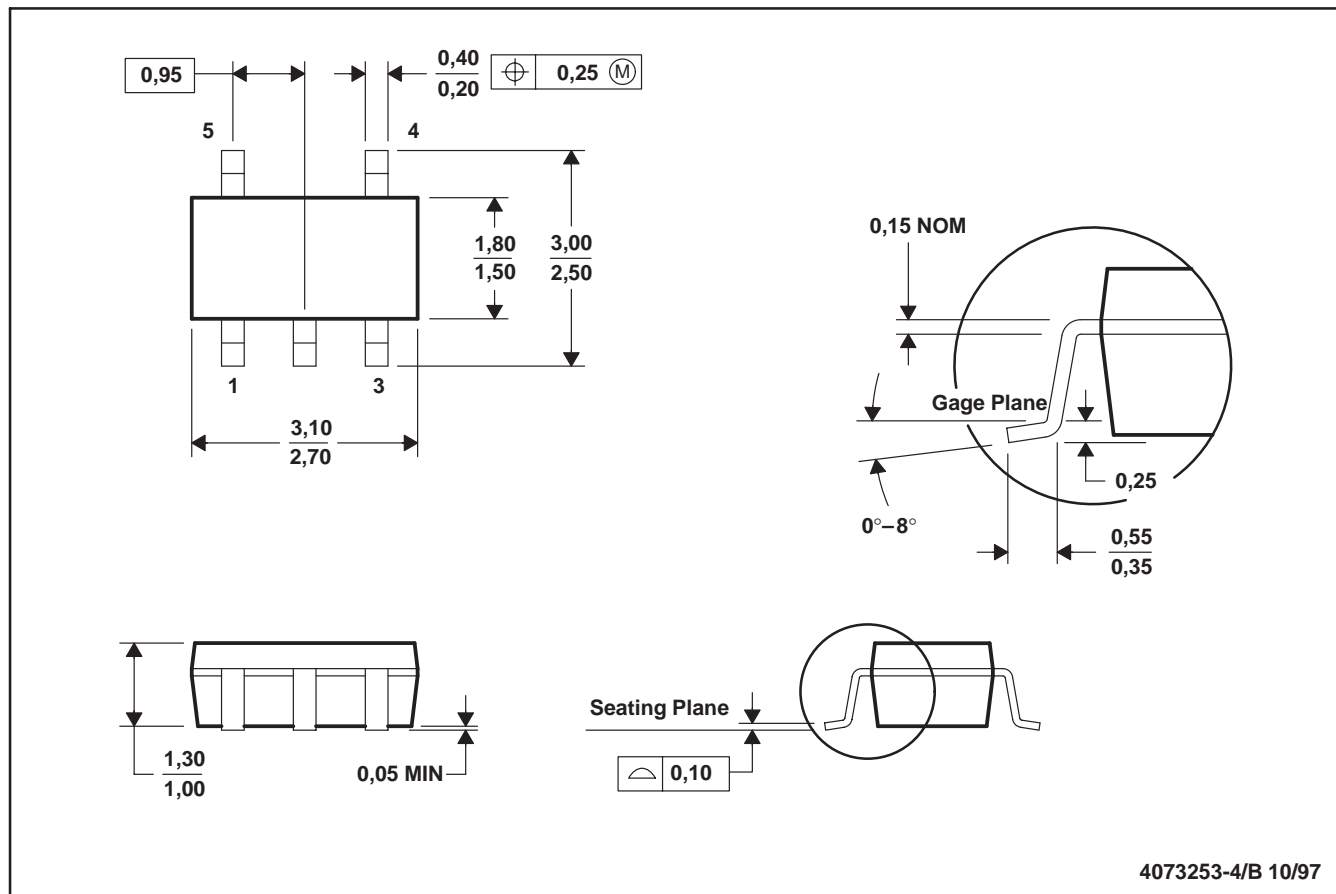

- NOTES: A. All linear dimensions are in millimeters.  
 B. This drawing is subject to change without notice.  
 C. Body dimensions include mold flash or protrusion.

## **IMPORTANT NOTICE**

Texas Instruments and its subsidiaries (TI) reserve the right to make changes to their products or to discontinue any product or service without notice, and advise customers to obtain the latest version of relevant information to verify, before placing orders, that information being relied on is current and complete. All products are sold subject to the terms and conditions of sale supplied at the time of order acknowledgement, including those pertaining to warranty, patent infringement, and limitation of liability.

TI warrants performance of its semiconductor products to the specifications applicable at the time of sale in accordance with TI's standard warranty. Testing and other quality control techniques are utilized to the extent TI deems necessary to support this warranty. Specific testing of all parameters of each device is not necessarily performed, except those mandated by government requirements.

**CERTAIN APPLICATIONS USING SEMICONDUCTOR PRODUCTS MAY INVOLVE POTENTIAL RISKS OF DEATH, PERSONAL INJURY, OR SEVERE PROPERTY OR ENVIRONMENTAL DAMAGE ("CRITICAL APPLICATIONS"). TI SEMICONDUCTOR PRODUCTS ARE NOT DESIGNED, AUTHORIZED, OR WARRANTED TO BE SUITABLE FOR USE IN LIFE-SUPPORT DEVICES OR SYSTEMS OR OTHER CRITICAL APPLICATIONS. INCLUSION OF TI PRODUCTS IN SUCH APPLICATIONS IS UNDERSTOOD TO BE FULLY AT THE CUSTOMER'S RISK.**

In order to minimize risks associated with the customer's applications, adequate design and operating safeguards must be provided by the customer to minimize inherent or procedural hazards.

TI assumes no liability for applications assistance or customer product design. TI does not warrant or represent that any license, either express or implied, is granted under any patent right, copyright, mask work right, or other intellectual property right of TI covering or relating to any combination, machine, or process in which such semiconductor products or services might be or are used. TI's publication of information regarding any third party's products or services does not constitute TI's approval, warranty or endorsement thereof.

Copyright © Each Manufacturing Company.

All Datasheets cannot be modified without permission.

This datasheet has been download from :

[www.AllDataSheet.com](http://www.AllDataSheet.com)

100% Free DataSheet Search Site.

Free Download.

No Register.

Fast Search System.

[www.AllDataSheet.com](http://www.AllDataSheet.com)