



STPS8L30B

LOW DROP POWER SCHOTTKY RECTIFIER

MAIN PRODUCT CHARACTERISTICS

I_{F(AV)}	8 A
V_{RRM}	30 V
T_{j (max)}	150 °C
V_{F (max)}	0.40 V

FEATURES AND BENEFITS

- LOW COST DEVICE WITH LOW DROP FORWARD VOLTAGE FOR LESS POWER DISSIPATION AND REDUCED HEATSINK
- OPTIMIZED CONDUCTION/REVERSE LOSSES TRADE-OFF WHICH LEADS TO THE HIGHEST YIELD IN THE APPLICATIONS
- HIGH POWER SURFACE MOUNT MINIATURE PACKAGE

DESCRIPTION

Single Schottky rectifier suited to Switched Mode Power Supplies and high frequency DC to DC converters.

Packaged in DPAK, this device is especially intended for use as a Rectifier at the secondary of 3.3V SMPS or DC/DC units.

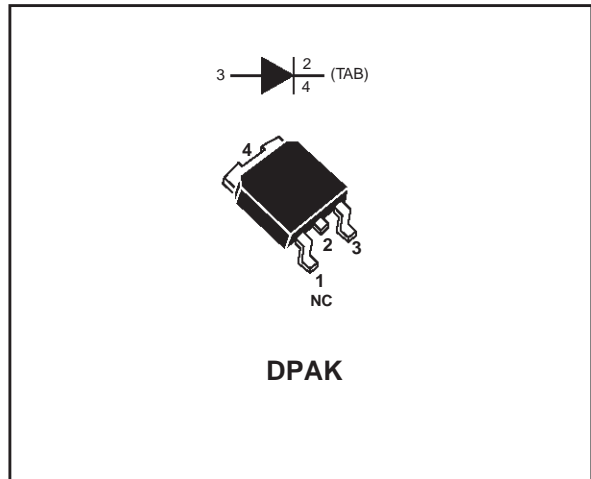

ABSOLUTE RATINGS (limiting values)

Symbol	Parameter		Value	Unit
V _{RRM}	Repetitive peak reverse voltage		30	V
I _{F(RMS)}	RMS forward current		7	A
I _{F(AV)}	Average forward current	T _c = 135°C δ = 0.5	8	A
I _{FSM}	Surge non repetitive forward current	t _p = 10 ms Sinusoidal	75	A
I _{R(RM)}	Repetitive peak reverse current	t _p = 2 μs F = 1kHz square	1	A
I _{R(SM)}	Non repetitive peak reverse current	t _p = 100μs square	2	A
T _{stg}	Storage temperature range		- 65 to + 150	°C
T _j	Maximum junction temperature		150	°C
dV/dt	Critical rate of rise of reverse voltage		10000	V/μs

* : $\frac{dP_{tot}}{dT_j} < \frac{1}{R_{th(j-a)}}$ thermal runaway condition for a diode on its own heatsink

STPS8L30B

THERMAL RESISTANCES

Symbol	Parameter	Value	Unit
$R_{th(j-c)}$	Junction to case	2.5	$^{\circ}\text{C}/\text{W}$

STATIC ELECTRICAL CHARACTERISTICS

Symbol	Tests Conditions	Tests Conditions	Min.	Typ.	Max.	Unit
I_R^*	Reverse leakage current	$T_j = 25^{\circ}\text{C}$	$V_R = V_{RRM}$		1	mA
		$T_j = 100^{\circ}\text{C}$		15	40	
V_F^*	Forward voltage drop	$T_j = 25^{\circ}\text{C}$	$I_F = 8\text{ A}$		0.49	V
		$T_j = 125^{\circ}\text{C}$		0.35	0.4	
		$T_j = 25^{\circ}\text{C}$	$I_F = 16\text{ A}$		0.63	
		$T_j = 125^{\circ}\text{C}$		0.48	0.57	

Pulse test : * $t_p = 380\ \mu\text{s}$, $\delta < 2\%$

To evaluate the maximum conduction losses use the following equation :
 $P = 0.23 \times I_{F(AV)} + 0.021 I_{F(RMS)}^2$

Fig. 1: Average forward power dissipation versus average forward current.

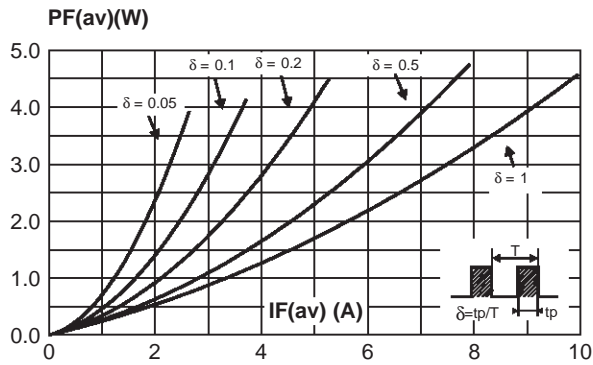

Fig. 2: Average forward current versus ambient temperature ($\delta=0.5$).

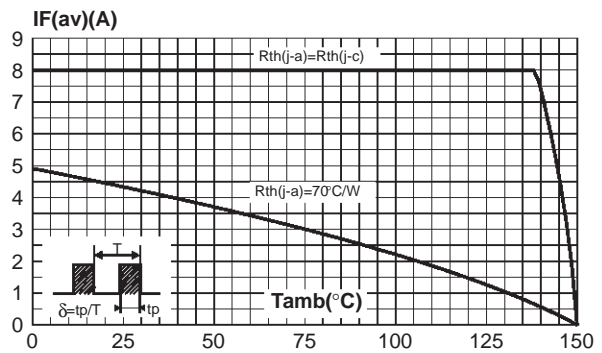

Fig. 3: Non repetitive surge peak forward current versus overload duration (maximum values).

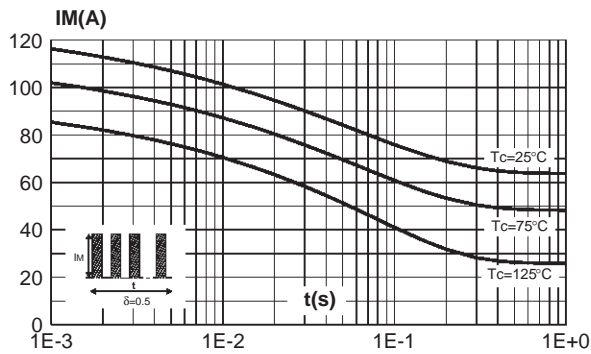

Fig. 4: Relative variation of thermal impedance junction to ambient versus pulse duration.

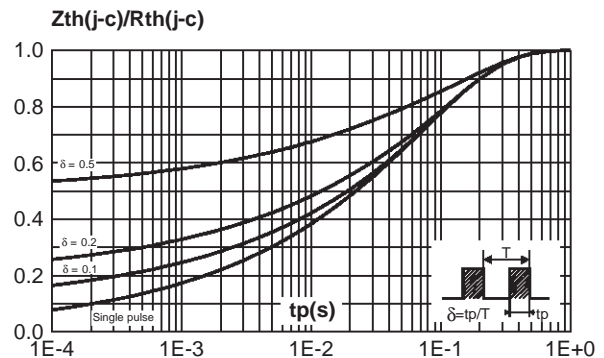

Fig. 5: Reverse leakage current versus reverse voltage applied (typical values).

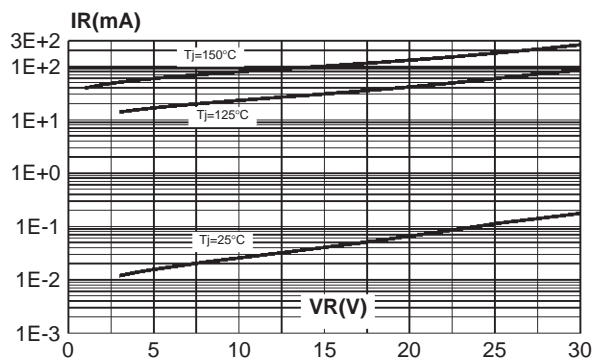

Fig. 6: Junction capacitance versus reverse voltage applied (typical values).

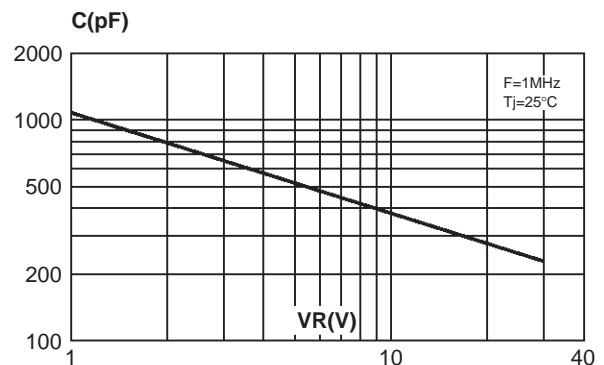

Fig. 7: Forward voltage drop versus forward current (maximum values).

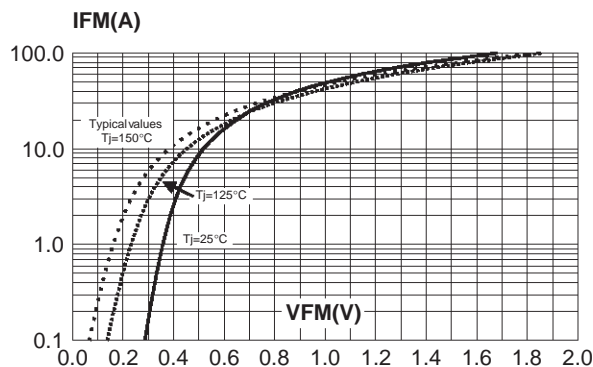
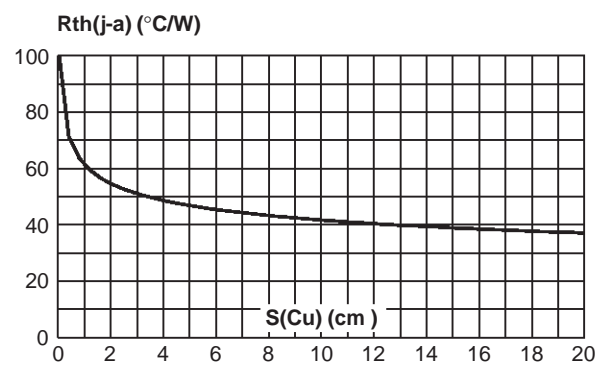
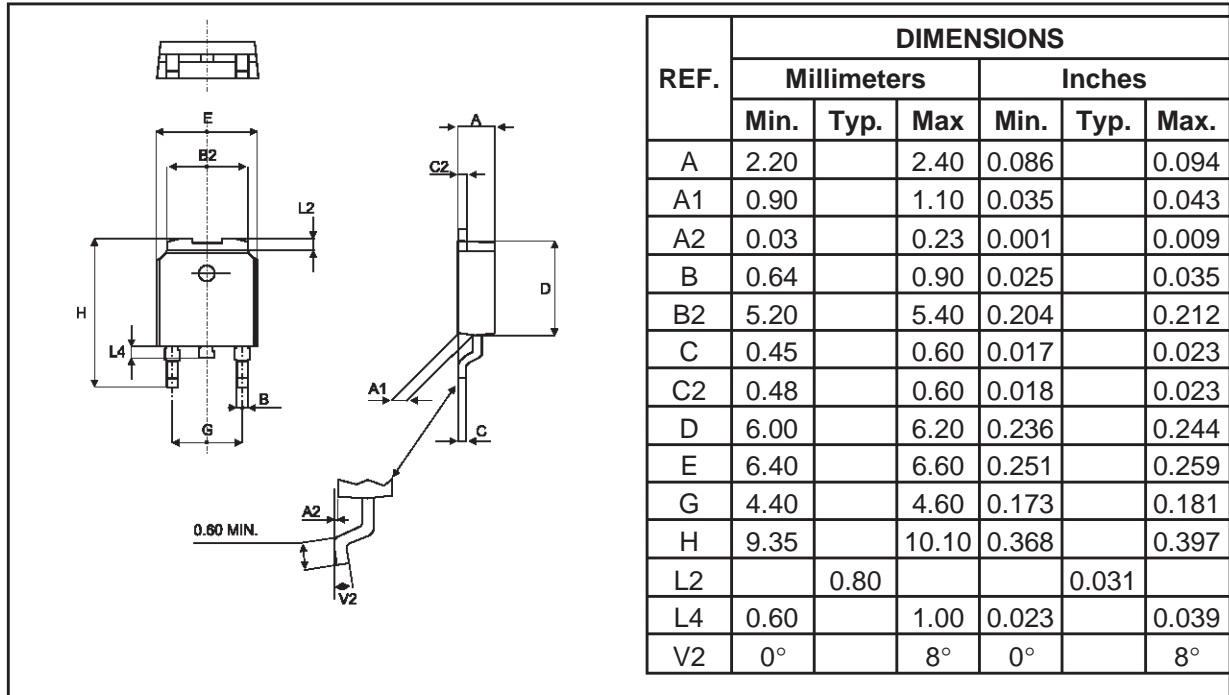

Fig. 8: Thermal resistance junction to ambient versus copper surface under tab (Epoxy printed circuit board FR4, copper thickness: 35µm).



STPS8L30B

PACKAGE MECHANICAL DATA DPAK



FOOT PRINT DIMENSIONS (in millimeters)

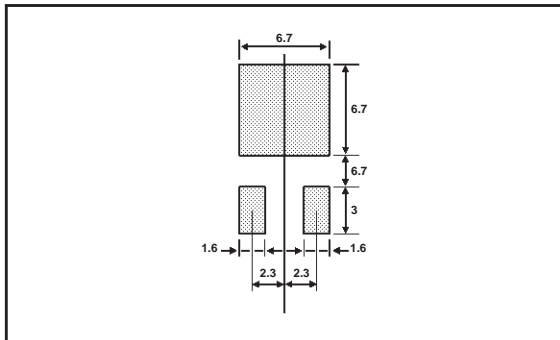

Ordering type	Marking	Package	Weight	Base qty	Delivery mode
STPS8L30B	STPS8L30B	DPAK	0.3g	75	Tube
STPS8L30B-TR	STPS8L30B	DPAK	0.3g	2500	Tape & reel

■ Epoxy meets UL94,V0

Information furnished is believed to be accurate and reliable. However, STMicroelectronics assumes no responsibility for the consequences of use of such information nor for any infringement of patents or other rights of third parties which may result from its use. No license is granted by implication or otherwise under any patent or patent rights of STMicroelectronics. Specifications mentioned in this publication are subject to change without notice. This publication supersedes and replaces all information previously supplied. STMicroelectronics products are not authorized for use as critical components in life support devices or systems without express written approval of STMicroelectronics.

The ST logo is a registered trademark of STMicroelectronics

© 1998 STMicroelectronics - Printed in Italy - All rights reserved.

STMicroelectronics GROUP OF COMPANIES

Australia - Brazil - Canada - China - France - Germany - Italy - Japan - Korea - Malaysia - Malta - Mexico - Morocco - The Netherlands - Singapore - Spain - Sweden - Switzerland - Taiwan - Thailand - United Kingdom - U.S.A.

<http://www.st.com>

Copyright © Each Manufacturing Company.

All Datasheets cannot be modified without permission.

This datasheet has been download from :

www.AllDataSheet.com

100% Free DataSheet Search Site.

Free Download.

No Register.

Fast Search System.

www.AllDataSheet.com