

DATA SHEET

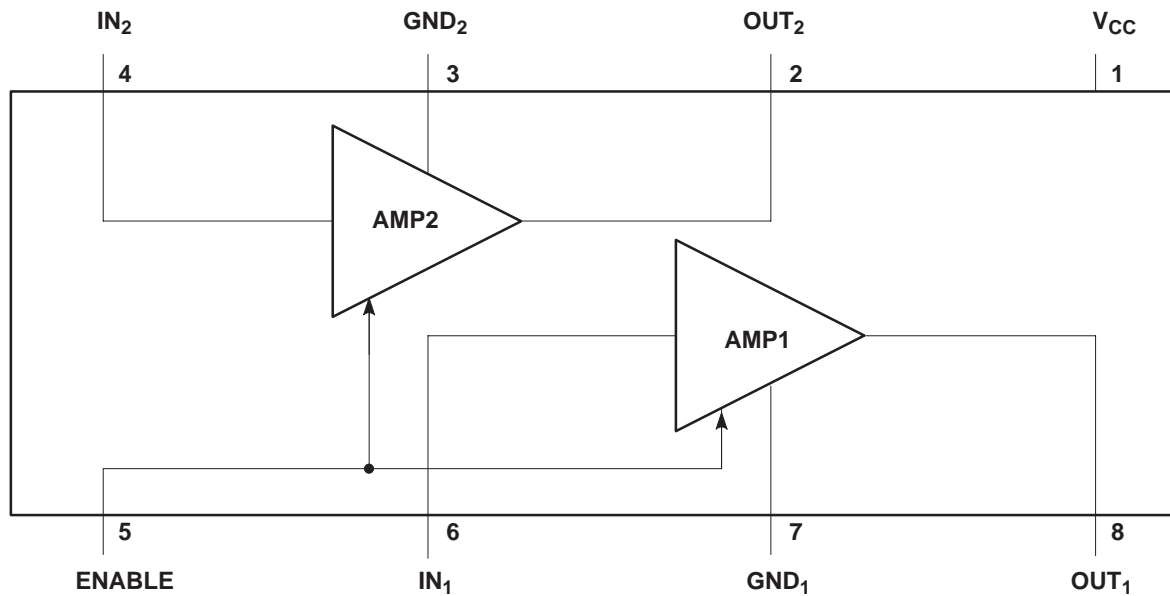

SA5200

RF dual gain-stage

Product Specification
 Replaces data of Oct 10 1991
 IC17 Data Handbook

1997 Nov 07

Philips Semiconductors



PHILIPS

RF dual gain-stage

SA5200

DESCRIPTION

The SA5200 is a dual amplifier with DC to 1200MHz response. Low noise (NF = 3.6dB) makes this part ideal for RF front-ends, and a simple power-down mode saves current for battery operated equipment. Inputs and outputs are matched to 50Ω.

The enable pin allows the designer the ability to turn the amplifiers on or off, allowing the part to act as an amplifier as well as an attenuator. This is very useful for front-end buffering in receiver applications.

FEATURES

- Dual amplifiers
- DC - 1200MHz operation
- Low DC power consumption (4.2mA per amplifier @ $V_{CC} = 5V$)
- Power-Down Mode ($I_{CC} = 95\mu A$ typical)
- 3.6dB noise figure at 900MHz
- Unconditionally stable
- Fully ESD protected
- Low cost

PIN CONFIGURATION

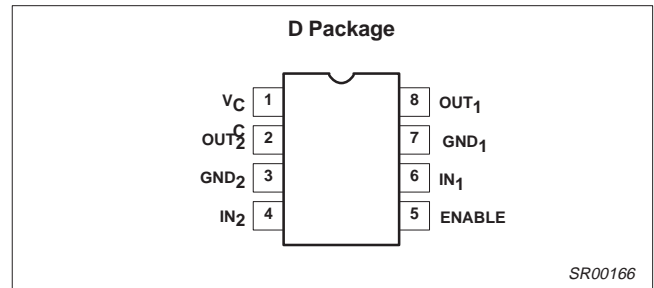

Figure 1. Pin Configuration

- Supply voltage 4-9V
- Gain $S_{21} = 7dB$ at $f = 1GHz$
- Input and output match S_{11}, S_{22} typically $< -14dB$

APPLICATIONS

- Cellular radios
- RF IF strips
- Portable equipment

ORDERING INFORMATION

DESCRIPTION	TEMPERATURE RANGE	ORDER CODE	DWG #
8-Pin Plastic Small Outline (Surface-mount)	-40-+85°C	SA5200D	SOT96-1

BLOCK DIAGRAM

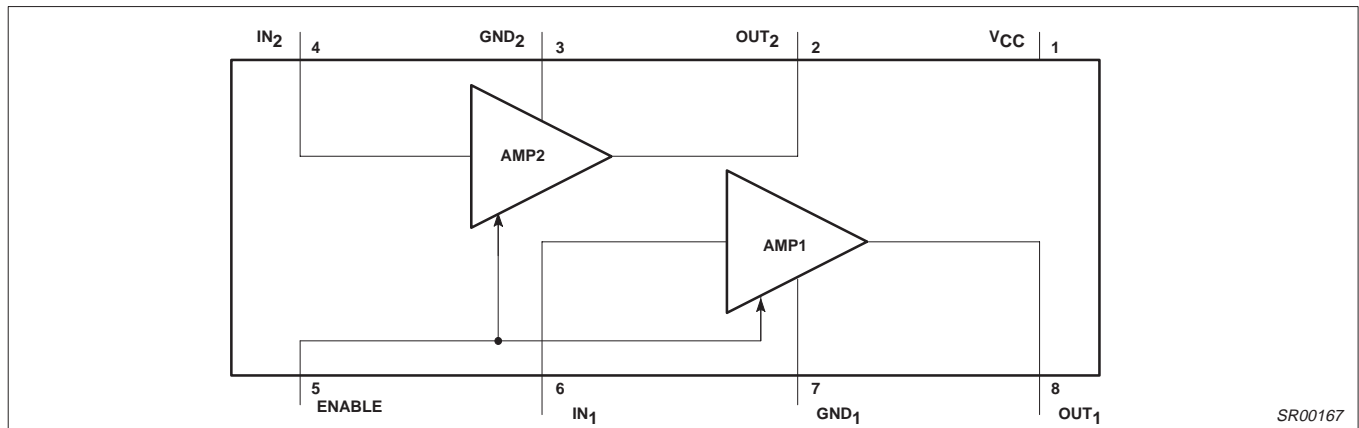

Figure 2. Block Diagram

RECOMMENDED OPERATING CONDITIONS

SYMBOL	PARAMETER	RATING	UNITS
V_{CC}	Supply voltage	4.0 to 9.0	V
T_A	Operating ambient temperature range SA Grade	-40 to +85	°C
T_J	Operating junction temperature SA Grade	-40 to +105	°C

RF dual gain-stage

SA5200

ABSOLUTE MAXIMUM RATINGS

SYMBOL	PARAMETER	RATING	UNITS
V_{CC}	Supply voltage ¹	-0.5 to +9	V
P_D	Power dissipation, $T_A = 25^\circ\text{C}$ (still air) ² 8-Pin Plastic SO	780	mW
T_{JMAX}	Maximum operating junction temperature	150	$^\circ\text{C}$
P_{MAX}	Maximum power input/output	+20	dBm
T_{STG}	Storage temperature range	-65 to +150	$^\circ\text{C}$

NOTE:

- Transients exceeding 10.5V on V_{CC} pin may damage product.
- Maximum dissipation is determined by the operating ambient temperature and the thermal resistance, θ_{JA} :
8-Pin SO: $\theta_{JA} = 158^\circ\text{C/W}$

DC ELECTRICAL CHARACTERISTICS

 $V_{CC} = +5\text{V}$, $T_A = 25^\circ\text{C}$; unless otherwise stated.

SYMBOL	PARAMETER	TEST CONDITIONS	LIMITS			UNITS
			MIN	TYP	MAX	
V_{CC}	Supply voltage		4	5.0	9.0	V
I_{CC}	Total supply current	$V_{CC} = 5\text{V}$, ENABLE = High	6.4	8.4	10.4	mA
		$V_{CC} = 5\text{V}$, ENABLE = Low		95	255	μA
		$V_{CC} = 9\text{V}$, ENABLE = High		17.8	22.2	mA
		$V_{CC} = 9\text{V}$, ENABLE = Low		320	960	μA
V_T	TTL/CMOS logic threshold voltage ¹			1.25		V
V_{IH}	Logic 1 level	Power-up mode	2.0		V_{CC}	V
V_{IL}	Logic 0 level	Power-down mode	-0.3		0.8	V
I_{IL}	Enable input current	Enable = 0.4V	-1	0	1	μA
I_{IH}	Enable input current	Enable = 2.4V	-1	0	1	μA
$V_{DC,ODC}$	Input and output DC levels		0.6	0.83	1.0	V

NOTE:

- The ENABLE input must be connected to a valid logic level for proper operation of the SA5200.

AC ELECTRICAL CHARACTERISTICS¹ $V_{CC} = +5\text{V}$, $T_A = 25^\circ\text{C}$, either amplifier, enable = 5V; unless otherwise stated.

SYMBOL	PARAMETER	TEST CONDITIONS	LIMITS			UNITS
			MIN	TYP	MAX	
S21	Insertion gain	$f = 100\text{MHz}$	9.2	11	13.2	dB
		$f = 900\text{MHz}$	5.2	7.5		
S22	Output return loss	$f = 900\text{MHz}$		-14.3		dB
S12	Reverse isolation	$f = 900\text{MHz}$		-17.9		dB
S11	Input return loss	$f = 900\text{MHz}$		-16.5		dB
P-1	Output 1dB compression point	$f = 900\text{MHz}$		-4.3		dBm
NF	Noise figure in 50 Ω	$f = 900\text{MHz}$		3.6		dB
IP ₂	Input second-order intercept point	$f = 900\text{MHz}$		+4.3		dBm
IP ₃	Input third-order intercept point	$f = 900\text{MHz}$		-1.8		dBm
ISOL	Amplifier-to-amplifier isolation ²	$f = 900\text{MHz}$		-25		dB
P _{OUT}	Saturated output power	$f = 900\text{MHz}$		-1.7		dBm
S21	Insertion gain when disabled	$f = 100\text{MHz}$		-13		dB
		$f = 900\text{MHz}$		-13.5		

NOTE:

- All measurements include the effects of the SA5200 Evaluation Board (see Figure 4). Measurement system impedance is 50 Ω .
- Input applied to one amplifier, output taken at the other output. All ports terminated into 50 Ω .

RF dual gain-stage

SA5200

APPLICATIONS

SA5200 is a user-friendly, wide-band, unconditionally stable, low power dual gain amplifier circuit. There are several advantages to using the SA5200 as a high frequency gain block instead of a discrete implementation. First is the simplicity of use. The SA5200 does not need any external biasing components. Due to the higher level of integration and small footprint (SO8) package it occupies less space on the printed circuit board and reduces the manufacturing cost of the system. Also the higher level of integration improves the reliability of the amplifier over a discrete implementation with several components. The power down mode in the SA5200 helps reduce power consumption in applications where the amplifiers can be disabled. And last but not the least is the impedance matching at inputs and outputs. Only those who have toiled through discrete transistor implementations for 50Ω input and output impedance matching can truly appreciate the elegance and simplicity of the SA5200 input and output impedance matching to 50Ω.

A simplified equivalent schematic is shown in 3. Each amplifier is composed of an NPN transistor with an Ft of 13GHz in a classical series-shunt feedback configuration. The two wideband amplifiers are biased from the same bias generator. In normal operation each amplifier consumes about 4mA of quiescent current (at V_{CC} = 5V). In the disable mode the device consumes about 90μA of current, most of it is in the TTL enable buffer and the bias generator. The input impedance of the amplifiers is 50Ω. The amplifiers have typical gain of 11dB at 100MHz and 7dB of gain at 1.2GHz.

It can be seen from 3 that any inductance between Pin 7, 3 and the ground plane will reduce the gain of the amplifiers at higher frequencies. Thus proper grounding of Pins 7 and 3 is essential for maximum gain and increased frequency response. 4 shows the printed circuit board layout and the component placement for the SA5200 evaluation board. The AC coupling capacitors should be selected such that they are shorts at the desired frequency of operation. Since most low-cost large value surface mount capacitors cease to be simply capacitors in the UHF range and exhibit an inductive behavior, it is recommended that high frequency chip capacitors be utilized in the circuit. A good power supply bypass is also essential for the performance of the amplifier and should be as close to the device as practical.

5 shows the typical frequency response of the two channels of SA5200. The low frequency gain is about 11dB at 100MHz and slowly drops off to 10dB at 500MHz. The gain is about 8dB at 900MHz and 7dB at 1.2 GHz which is typical of SA5200 with a good printed circuit board layout. It can also be seen that both channels have a very well matched frequency response and matched gain to within 0.1dB at 100MHz and 0.2dB at 900MHz.

SA5200 finds applications in many areas of RF communications. It is an ideal gain block for high performance, low cost, low power RF communications transceivers. A typical radio transceiver front-end is shown in 6. This could be the front-end of a cellular phone, a VHF/ UHF hand-held transceiver, UHF cordless telephone or a spread spectrum system. The SA5200 can be used in the receiver path of most systems as an LNA and pre-amplifier. The bandpass filter between the two amplifiers also minimize the noise into the first mixer. In the transmitter path, SA5200 can be used as a buffer to the VCO and isolate the VCO from any load variations due to the power level changes in the power amplifier. This improves the stability of the VCOs. The SA5200 can also be used as a pre-driver to the power amplifier modules.

The two amplifiers in SA5200 can be easily cascaded to have a 13dB gain block at 900MHz. At 100MHz the gain will be 22dB and a noise figure of about 5.5dB. The SA5200 can be operated at a higher voltage up to 9V for much improved 1dB output compression point and higher 3rd order intercept point.

Several stages of SA5200 can also be cascaded and be used as an IF amplifier strip for DBS/TV/GPS receivers. 7 shows a 60dB gain IF strip at 180MHz. The noise figure for the cascaded amplifier chain is given by equation 1.

$$NF \text{ (total)} = NF1 + NF2/G1 + NF3/G1*G2 + NF4/G1*G2*G3 + \dots$$

(Equation. 1)

NOTE: The noise figure and gain should not be in dB in the above equation.

Since the noise figure for each stage is about 3.6dB and the gain is about 11dB, the noise figure for the 60dB gain IF strip will be about 6.4dB.

In applications where a single amplifier is required with a 7.5dB gain at 900MHz and current consumption is of paramount importance (battery powered receivers), the amplifier A1 can be used and amplifier A2 can be disabled by leaving GND2 (Pin 3) unconnected. This will reduce the total current consumption for the IC to a meager 4mA.

The ENABLE pin is useful for Time-Division-Duplex systems where the receiver can be disabled for a period of time. In this case the overall system supply current will be decreased by 8mA.

The ENABLE pin can also be used to improve the system dynamic range. For input levels that are extremely high, the SA5200 can be disabled. In this case the input signal is attenuated by 13dB. This prevents the system from being overloaded as well as improves the system's overall dynamic range. In the disabled condition the SA5200 IP₃ increases to nearly +20dBm.

RF dual gain-stage

SA5200

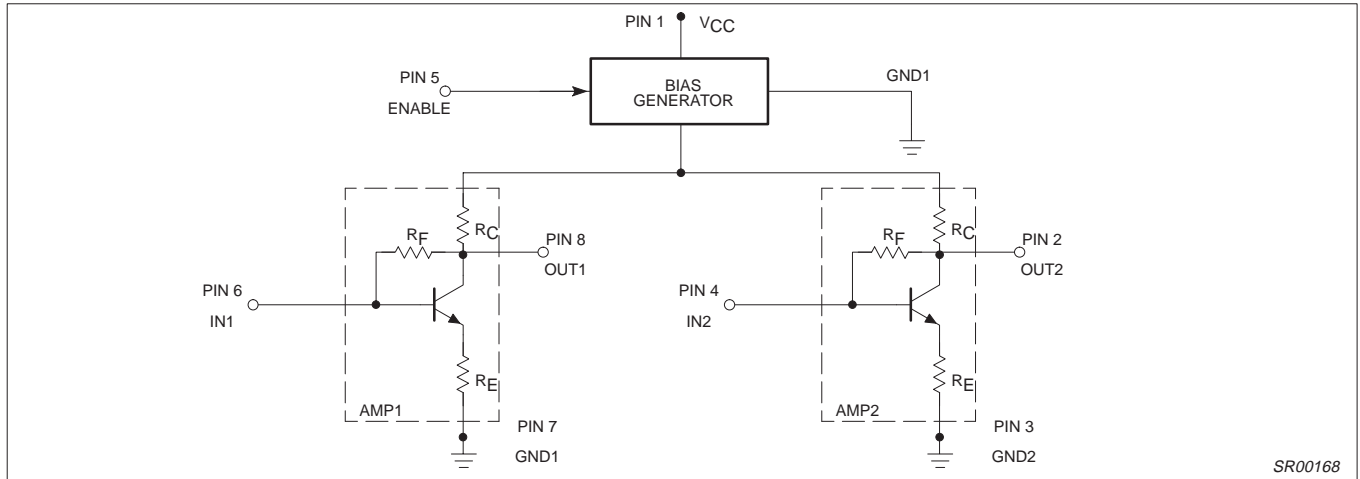

Figure 3. Simplified Equivalent Schematic of SA5200

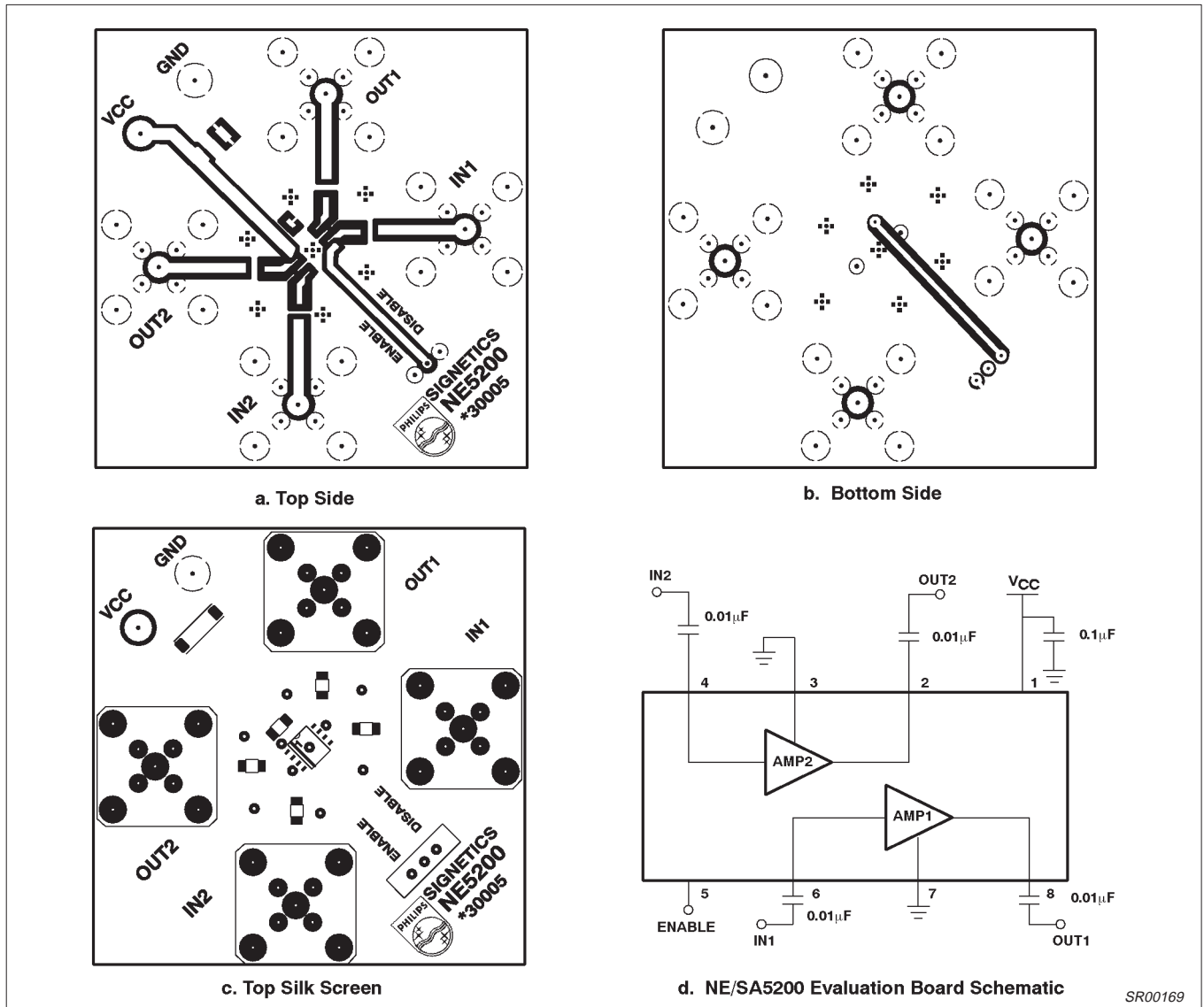

Figure 4. Printed Circuit Board Layout of the SA5200 Evaluation Board

RF dual gain-stage

SA5200

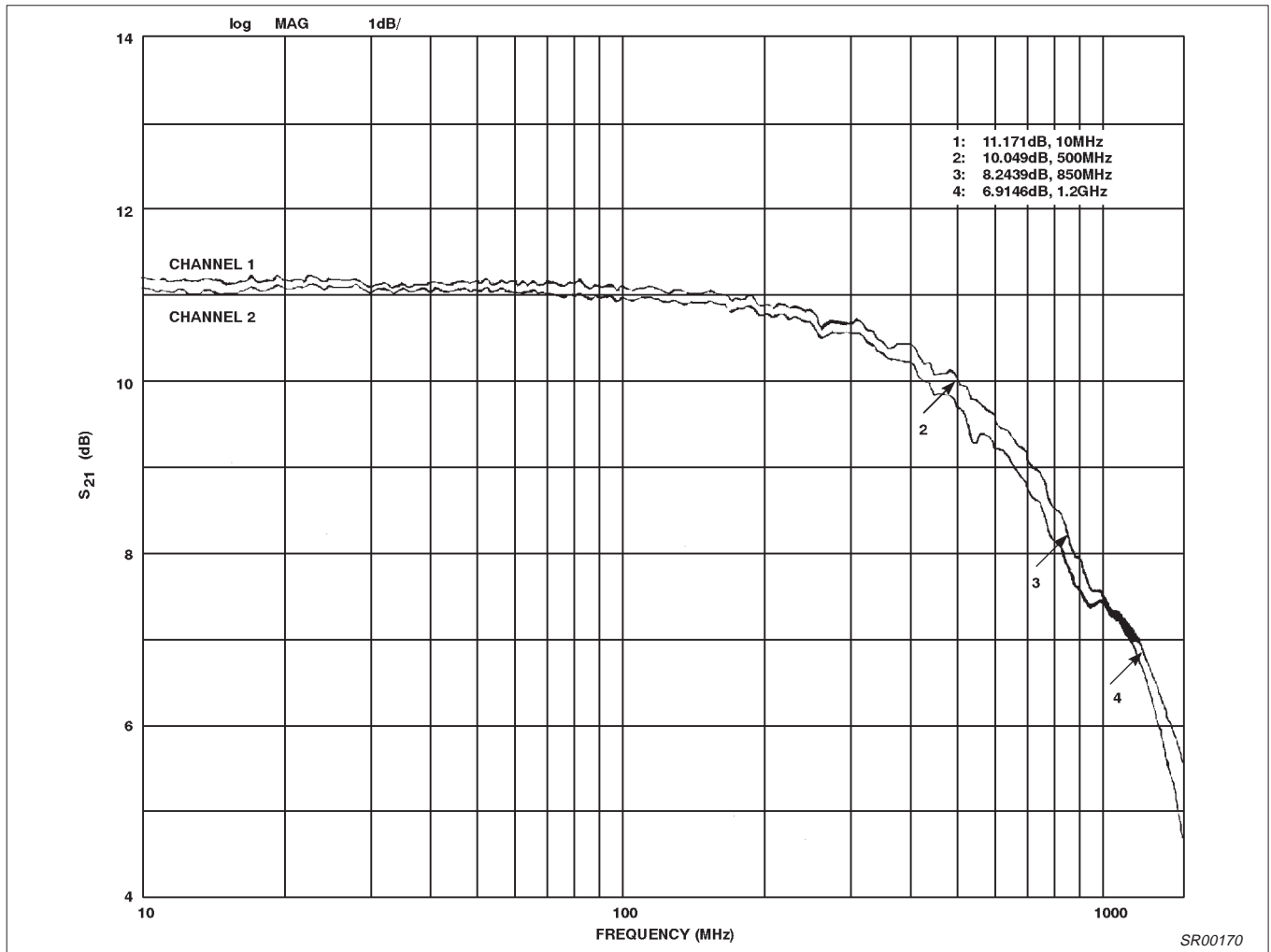

Figure 5. Typical Frequency Response of SA5200 in a 50Ω System

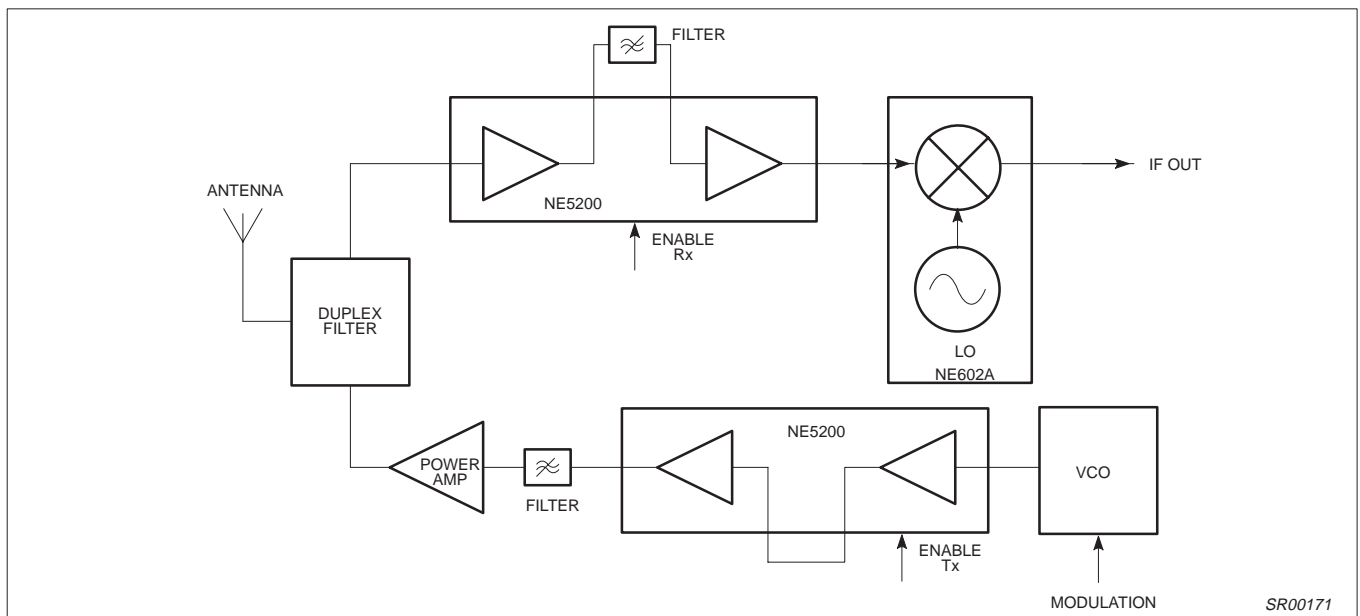

Figure 6. Typical Radio Transceiver Front-End

RF dual gain-stage

SA5200

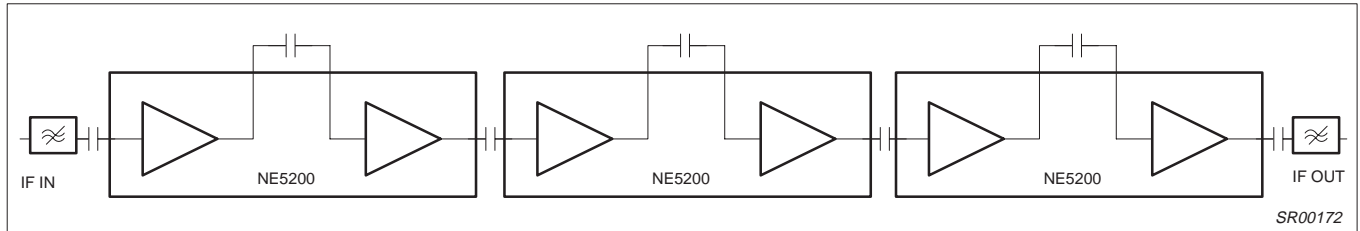

Figure 7. 60dB IF Gain Block for 100-300MHz IF for GPS/DBS Systems

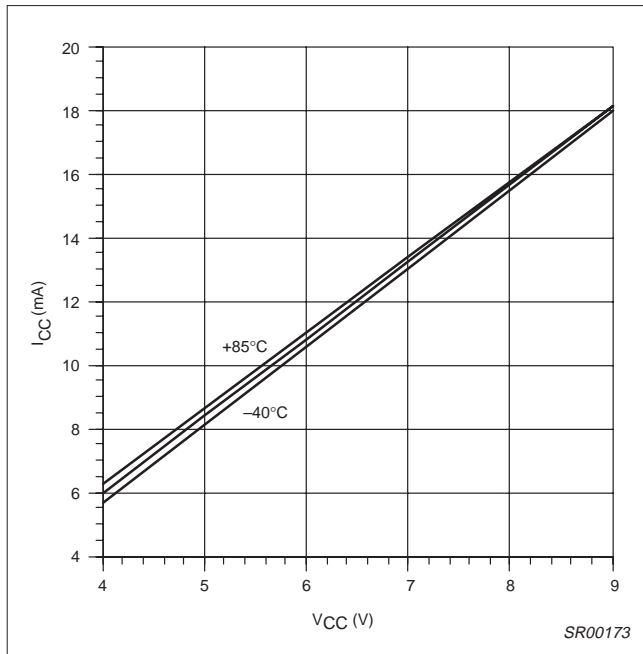

Figure 8. Supply Current vs Supply Voltage and Temperature

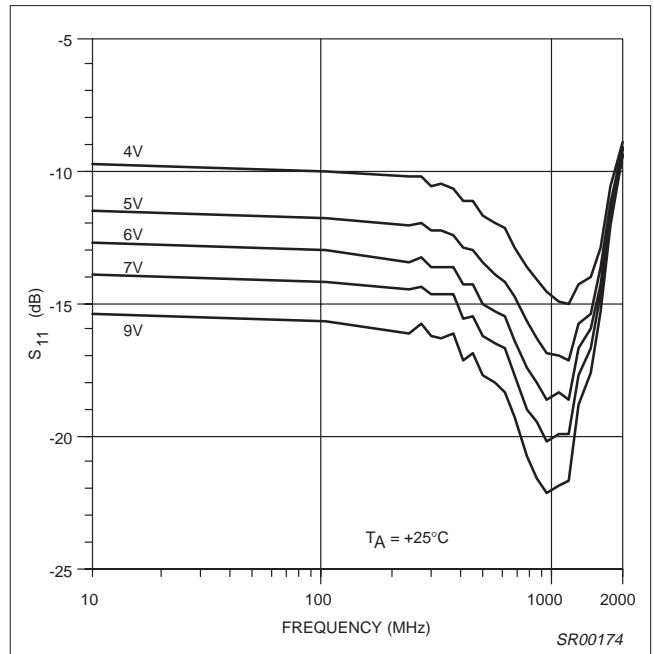

Figure 10. Input Match vs Frequency and V_{CC}

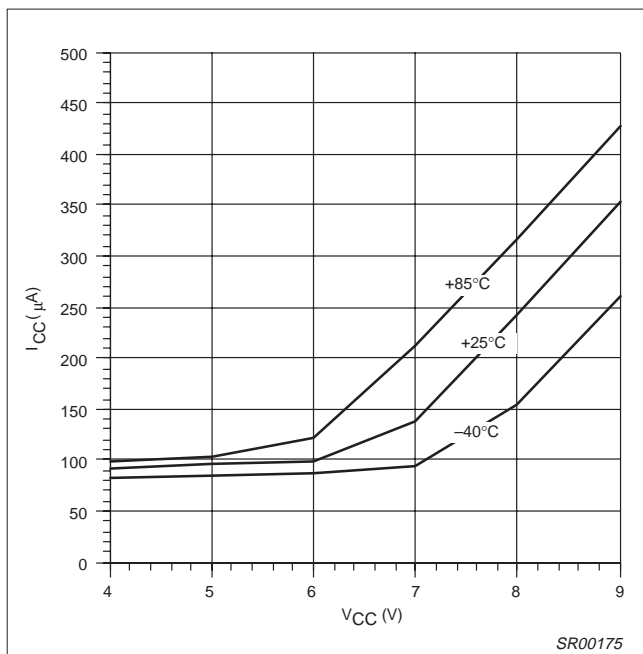

Figure 9. Disabled Supply Current vs V_{CC} and Temperature

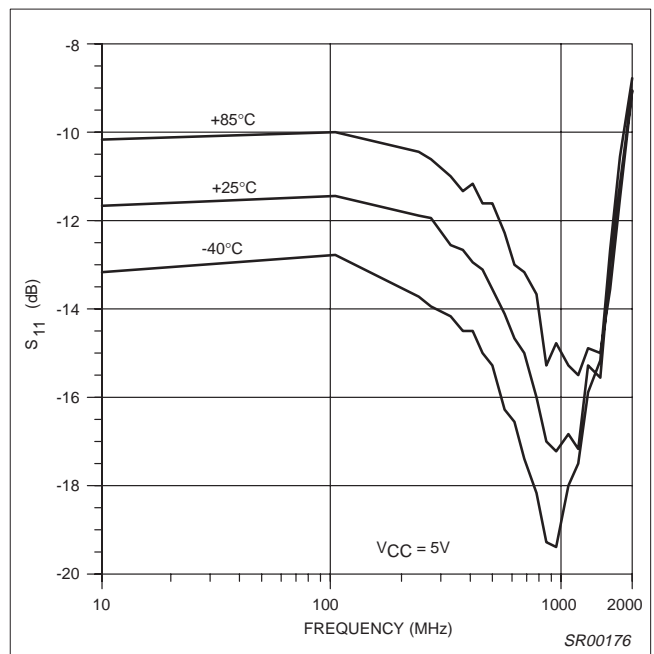

Figure 11. Input Match vs Frequency and Temperature

RF dual gain-stage

SA5200

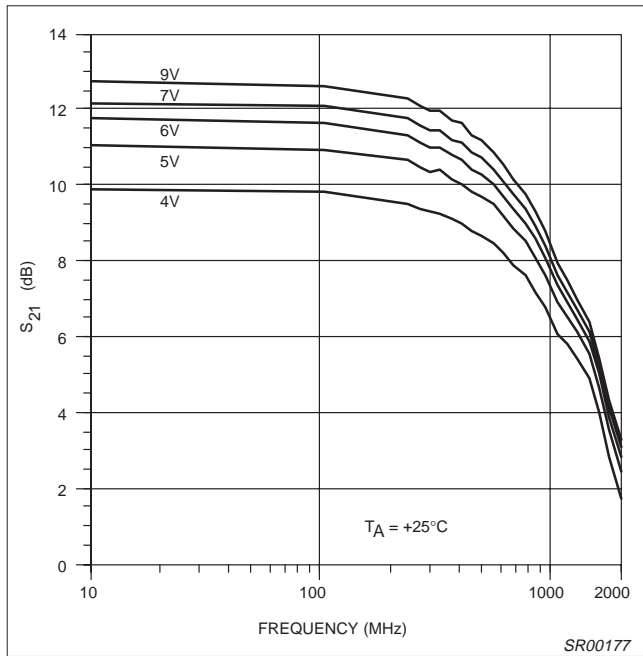

Figure 12. Insertion Gain vs Frequency and V_{CC}

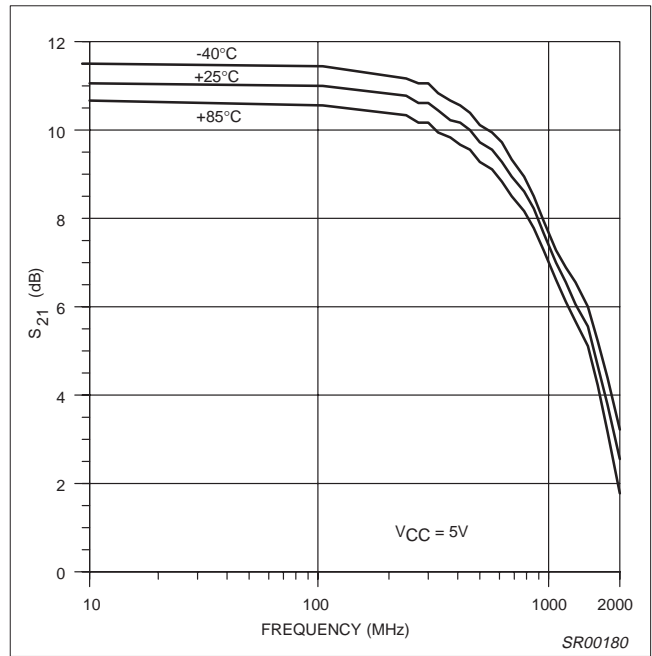

Figure 14. Insertion Gain vs Frequency and Temperature

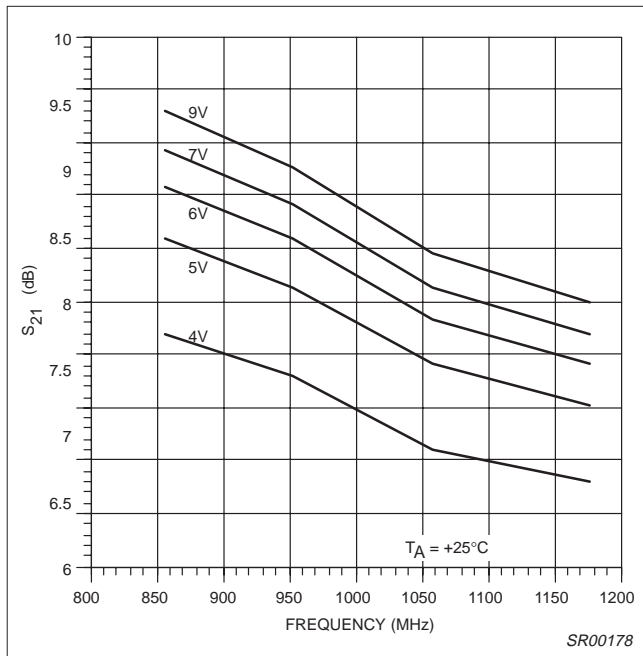

Figure 13. Insertion Gain vs Frequency and V_{CC}
— Expanded Detail —

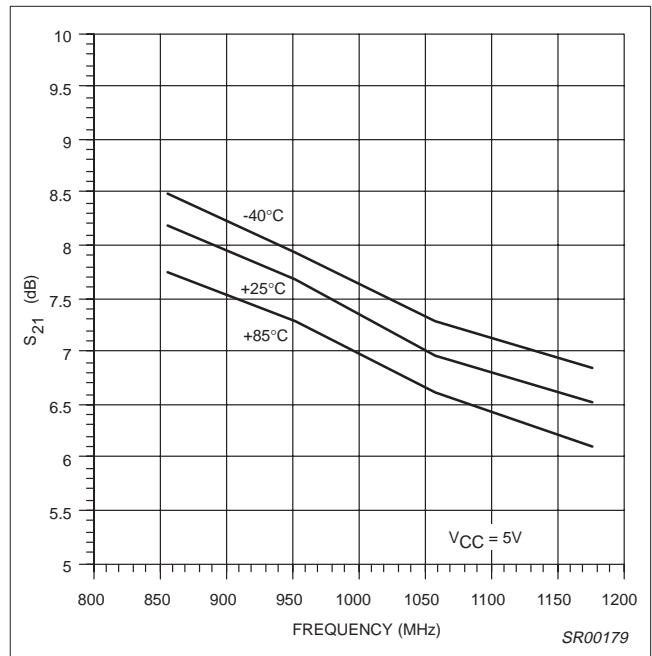

Figure 15. Insertion Gain vs Frequency and Temperature
— Expanded Detail —

RF dual gain-stage

SA5200

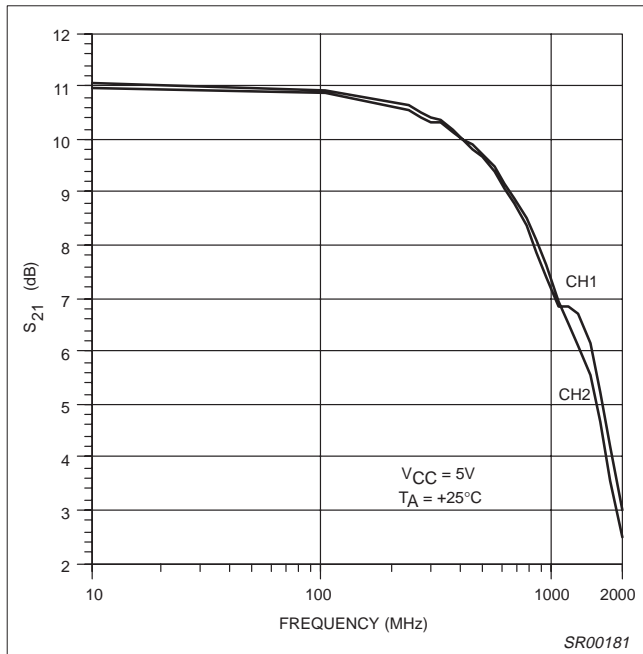

Figure 16. Insertion Gain Matching (CH1 vs CH2) vs Frequency

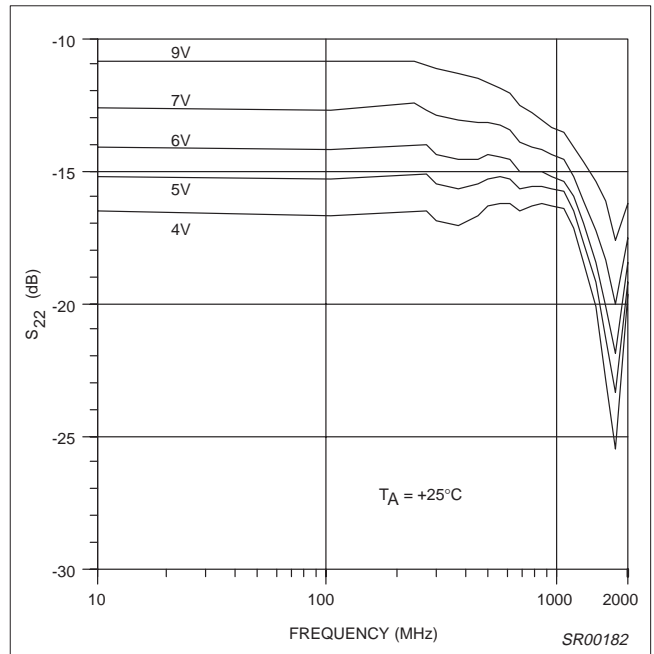

Figure 18. Output Match vs Frequency and VCC

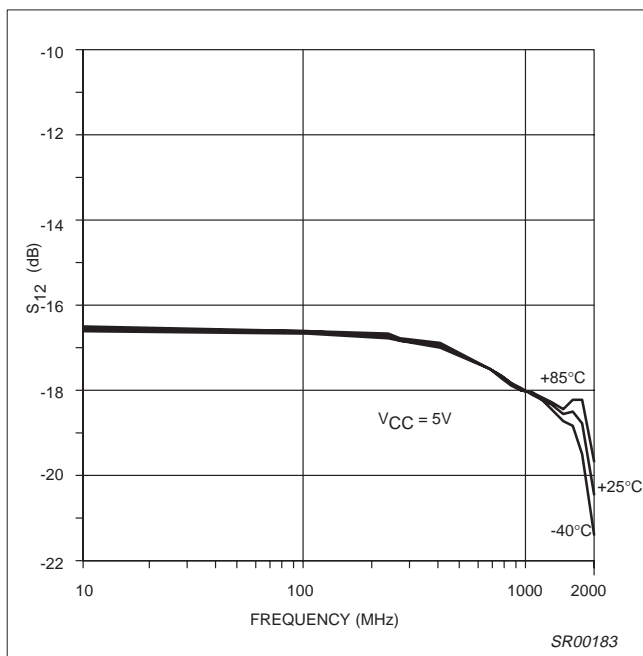

Figure 17. Reverse Insertion Gain vs Frequency and Temperature

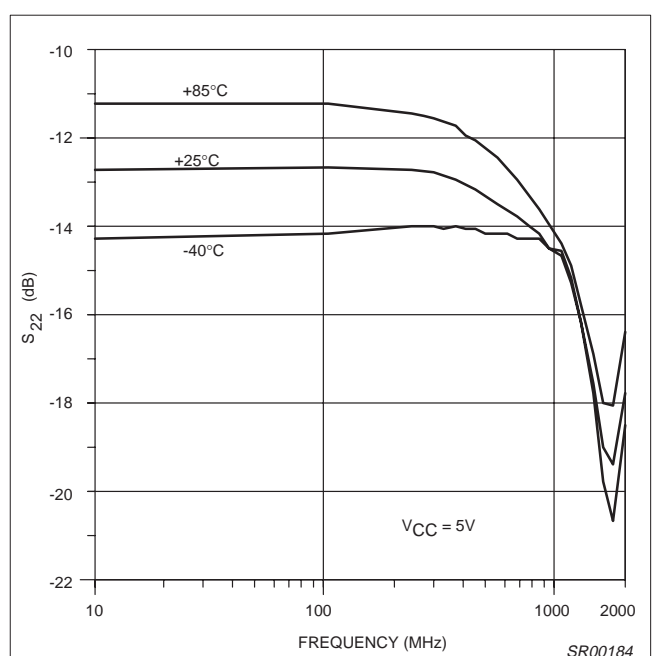

Figure 19. Output Match vs Frequency and Temperature

RF dual gain-stage

SA5200

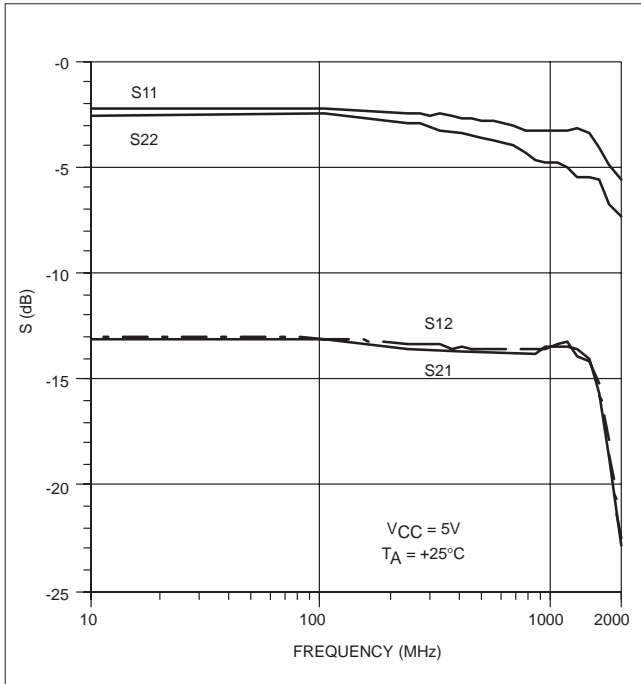

Figure 20. S-parameters vs Frequency for Disabled Amplifier

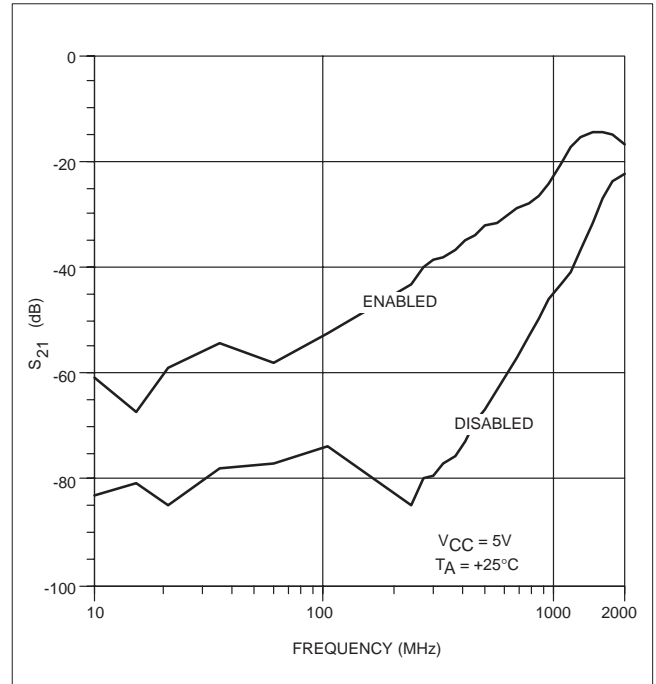

Figure 22. CH1 Input to CH2 Output Isolation vs Frequency

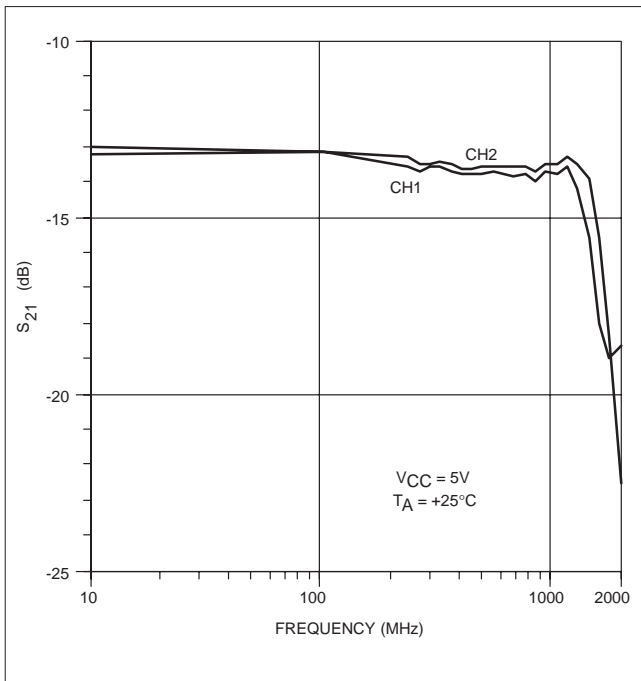

Figure 21. Insertion Gain Matching Disabled (CH1 vs CH2) vs Frequency

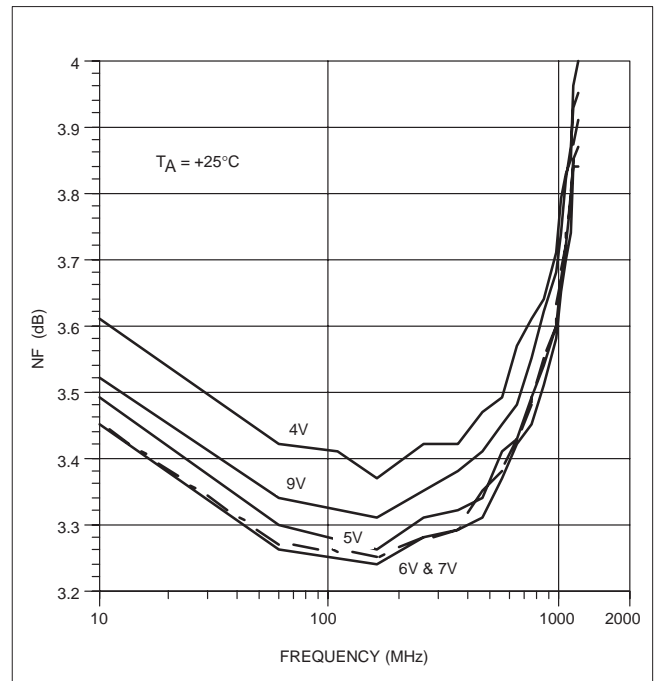

Figure 23. Noise Figure vs Frequency and V_{CC} in a 50Ω System

RF dual gain-stage

SA5200

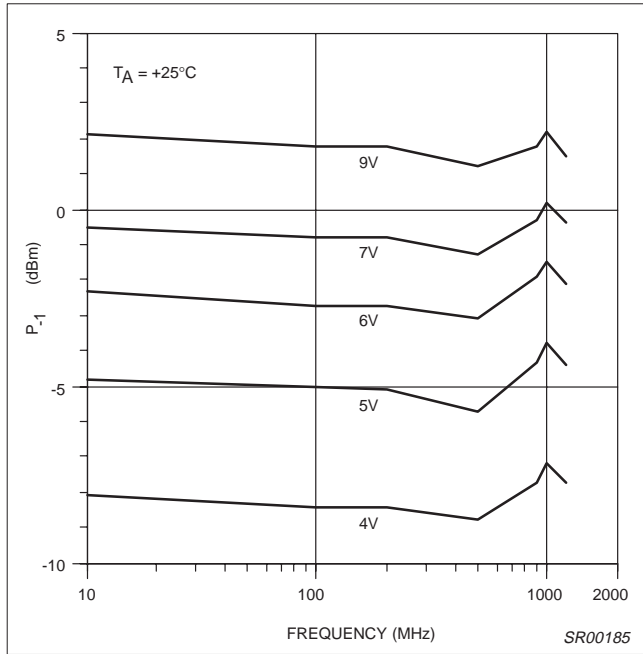

Figure 24. 1dB Output Compression Point vs Frequency and V_{CC}

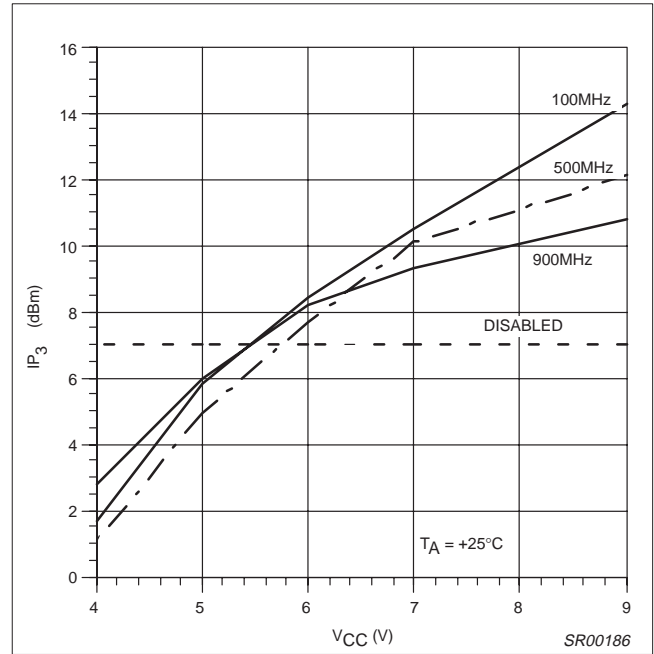

Figure 26. Third-Order Output Intercept vs Frequency and V_{CC}

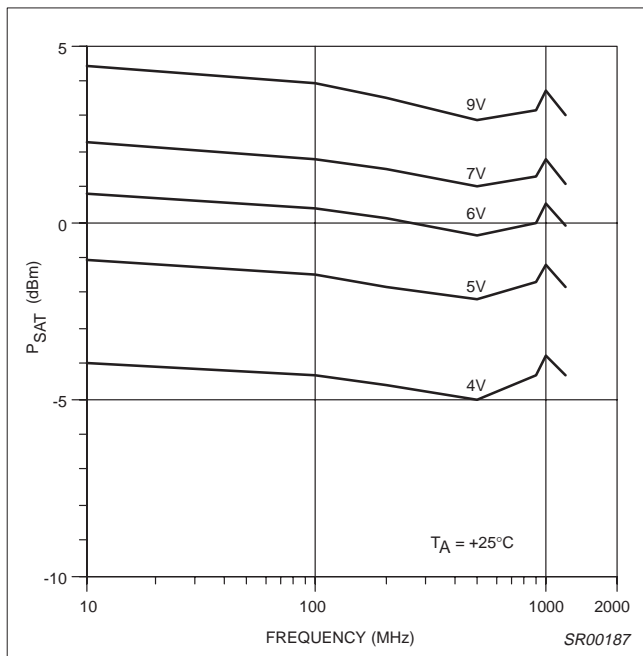

Figure 25. Saturated Output Power vs Frequency and V_{CC}

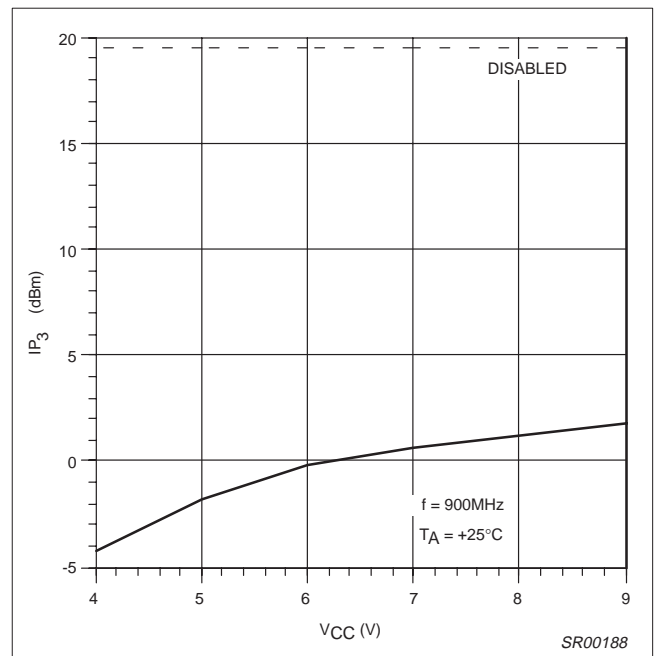

Figure 27. Third-Order Input Intercept vs Frequency and V_{CC}

RF dual gain-stage

SA5200

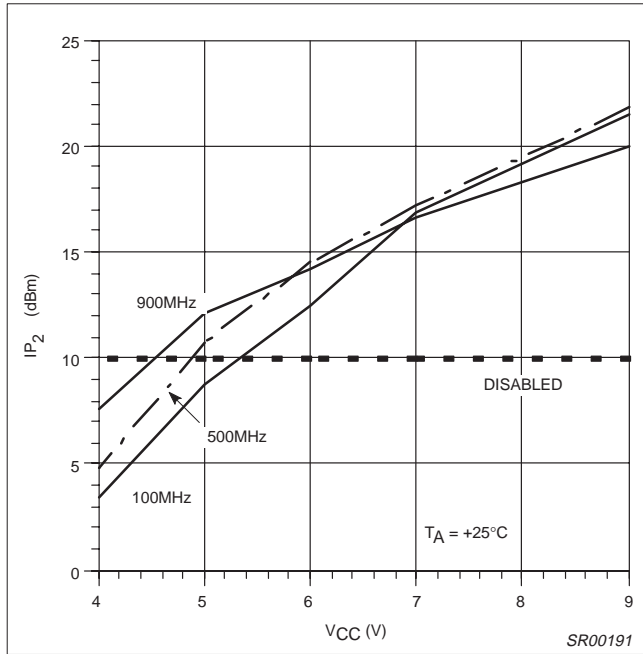

Figure 28. Second-Order Output Intercept vs Frequency and V_{CC}

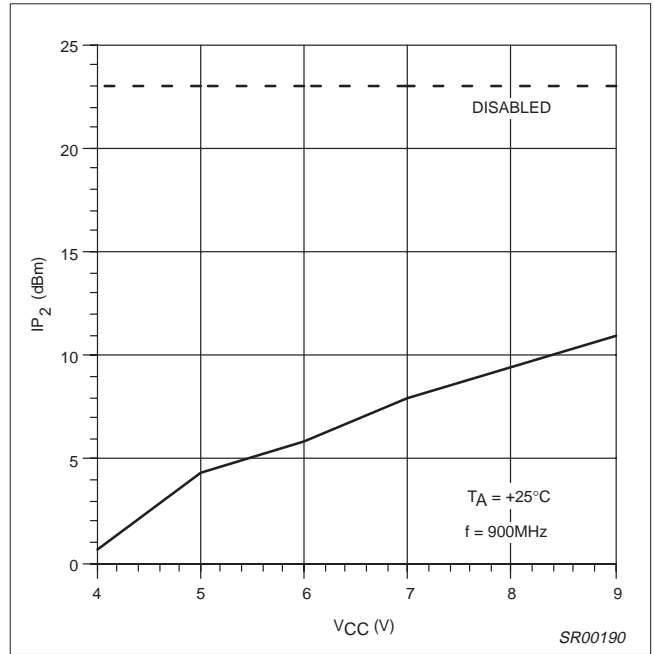

Figure 30. Second-Order Input Intercept vs Frequency and V_{CC}

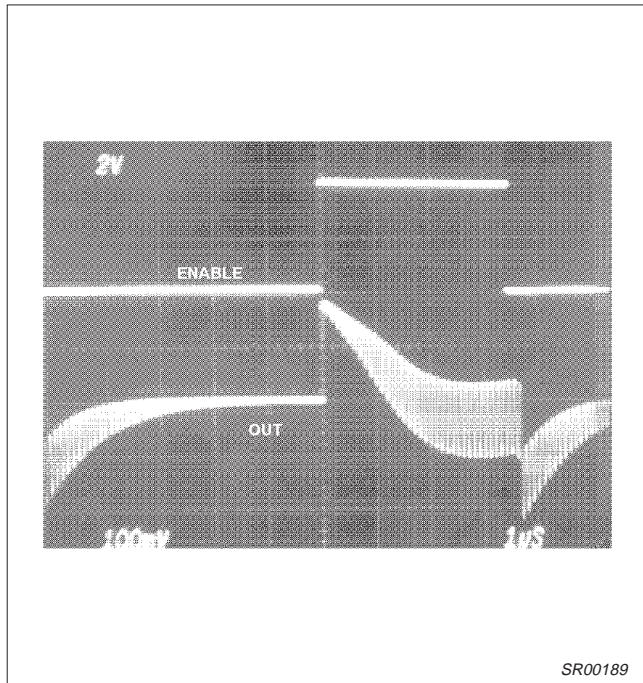

Figure 29. Switching Speed; $f_{IN} = 10\text{MHz}$ at -26dBm , $V_{DD} = 5\text{V}$, Coupling Capacitors Set to $0.01\mu\text{F}$

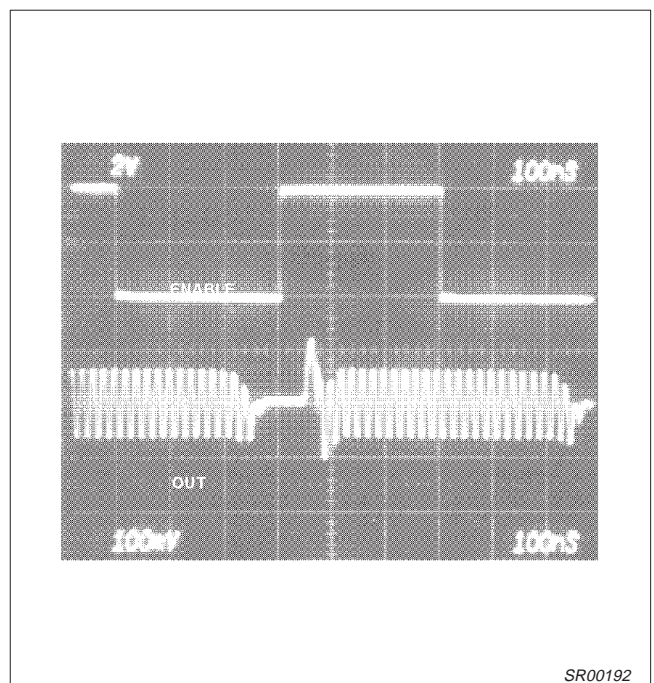

Figure 31. Switching Speed; $f_{IN} = 50\text{MHz}$ at -26dBm , $V_{DD} = 5\text{V}$, Coupling Capacitors Set to 100pF

RF dual gain-stage

SA5200

SO8: plastic small outline package; 8 leads; body width 3.9mm

SOT96-1

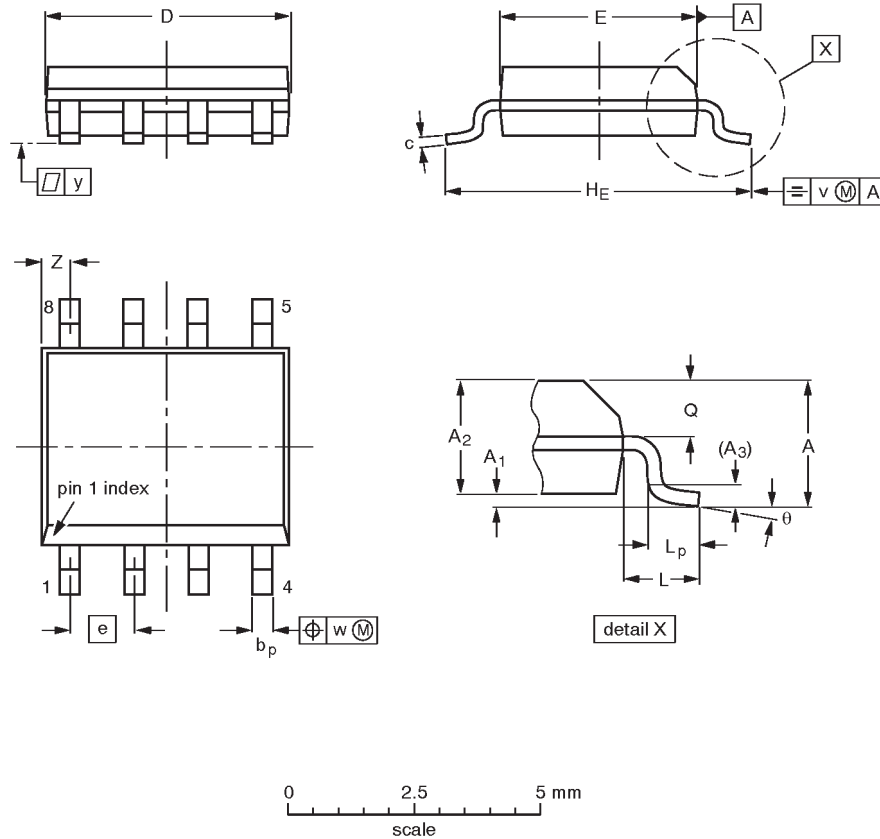

DIMENSIONS (inch dimensions are derived from the original mm dimensions)

UNIT	A max.	A ₁	A ₂	A ₃	b _p	c	D ⁽¹⁾	E ⁽²⁾	e	H _E	L	L _p	Q	v	w	y	Z ⁽¹⁾	θ
mm	1.75	0.25 0.10	1.45 1.25	0.25	0.49 0.36	0.25 0.19	5.0 4.8	4.0 3.8	1.27	6.2 5.8	1.05	1.0 0.4	0.7 0.6	0.25	0.25	0.1	0.7 0.3	8° 0°
inches	0.069	0.0098 0.0039	0.057 0.049	0.01	0.019 0.014	0.0098 0.0075	0.20 0.19	0.16 0.15	0.050	0.24 0.23	0.041	0.039 0.016	0.028 0.024	0.01	0.01	0.004	0.028 0.012	

Notes

1. Plastic or metal protrusions of 0.15 mm maximum per side are not included.
2. Plastic or metal protrusions of 0.25 mm maximum per side are not included.

OUTLINE VERSION	REFERENCES				EUROPEAN PROJECTION	ISSUE DATE
	IEC	JEDEC	EIAJ			
SOT96-1	076E03S	MS-012AA				92-11-17 95-02-04

RF dual gain-stage

SA5200

DEFINITIONS

Data Sheet Identification	Product Status	Definition
<i>Objective Specification</i>	Formative or in Design	This data sheet contains the design target or goal specifications for product development. Specifications may change in any manner without notice.
<i>Preliminary Specification</i>	Preproduction Product	This data sheet contains preliminary data, and supplementary data will be published at a later date. Philips Semiconductors reserves the right to make changes at any time without notice in order to improve design and supply the best possible product.
<i>Product Specification</i>	Full Production	This data sheet contains Final Specifications. Philips Semiconductors reserves the right to make changes at any time without notice, in order to improve design and supply the best possible product.

Philips Semiconductors and Philips Electronics North America Corporation reserve the right to make changes, without notice, in the products, including circuits, standard cells, and/or software, described or contained herein in order to improve design and/or performance. Philips Semiconductors assumes no responsibility or liability for the use of any of these products, conveys no license or title under any patent, copyright, or mask work right to these products, and makes no representations or warranties that these products are free from patent, copyright, or mask work right infringement, unless otherwise specified. Applications that are described herein for any of these products are for illustrative purposes only. Philips Semiconductors makes no representation or warranty that such applications will be suitable for the specified use without further testing or modification.

LIFE SUPPORT APPLICATIONS

Philips Semiconductors and Philips Electronics North America Corporation Products are not designed for use in life support appliances, devices, or systems where malfunction of a Philips Semiconductors and Philips Electronics North America Corporation Product can reasonably be expected to result in a personal injury. Philips Semiconductors and Philips Electronics North America Corporation customers using or selling Philips Semiconductors and Philips Electronics North America Corporation Products for use in such applications do so at their own risk and agree to fully indemnify Philips Semiconductors and Philips Electronics North America Corporation for any damages resulting from such improper use or sale.

Philips Semiconductors
811 East Arques Avenue
P.O. Box 3409
Sunnyvale, California 94088-3409
Telephone 800-234-7381

Philips Semiconductors and Philips Electronics North America Corporation register eligible circuits under the Semiconductor Chip Protection Act.
 © Copyright Philips Electronics North America Corporation 1993
 All rights reserved. Printed in U.S.A.