

INTEGRATED CIRCUITS

DATA SHEET



SAA4977H Basic

Preliminary specification
File under Integrated Circuits, IC02

1998 Jul 23

Basic**SAA4977H****CONTENTS**

1	FEATURES
2	GENERAL DESCRIPTION
3	QUICK REFERENCE DATA
4	ORDERING INFORMATION
5	BLOCK DIAGRAM
6	PINNING INFORMATION
6.1	Pinning
6.2	Pin description
7	FUNCTIONAL DESCRIPTION
7.1	Analog-to-digital conversion
7.2	Digital processing at $1f_H$ level
7.3	Digital processing at $2f_H$ level
7.4	Digital-to-analog conversion
7.5	Microprocessor
7.6	Memory controller
7.7	Line locked clock generation
7.8	Clock and sync interfacing
7.9	4 : 1 : 1 I/O interfacing
7.10	Test mode operation
7.11	I ² C-bus control registers
8	LIMITING VALUES
9	THERMAL CHARACTERISTICS
10	CHARACTERISTICS
11	APPLICATION
12	PACKAGE OUTLINE
13	SOLDERING
13.1	Introduction
13.2	Reflow soldering
13.3	Wave soldering
13.4	Repairing soldered joints
14	DEFINITIONS
15	LIFE SUPPORT APPLICATIONS
16	PURCHASE OF PHILIPS I ² C COMPONENTS

Basic

SAA4977H

1 FEATURES

- Internal prefilter
- Clamp circuit
- Analog AGC
- Line locked PLL
- Triple YUV 8-bit Analog-to-Digital Converter (ADC)
- Horizontal compression
- Field rate up-conversion (50 to 100 Hz or 60 to 120 Hz)
- 4 : 1 : 1 digital I/O interface
- Digital CTI (DCTI)
- Digital luminance peaking
- Triple 10-bit Digital-to-Analog Converter (DAC)
- Memory controller
- Embedded microprocessor
- 16 kbyte ROM
- 256 byte RAM
- I²C-bus interface



- Synchronous No parity Eight bit Reception and Transmission (SNERT) interface.

2 GENERAL DESCRIPTION

The SAA4977H is a video processing IC providing analog YUV interfacing, video enhancing features, memory controlling and an embedded 80C51 microprocessor core. It is applicable especially for field rate up-conversion (50 to 100 Hz or 60 to 120 Hz) in cooperation with a 2.9 Mbit field memory. It is designed for applications together with:

- SAA4955/56TJ, TMS4C2972/73 (serial field memories)
- SAA4990H (PROZONIC)
- SAA4991WP (MELZONIC).

3 QUICK REFERENCE DATA

SYMBOL	PARAMETER	MIN.	TYP.	MAX.	UNIT
V _{DDA(1,2,3)}	analog supply voltage front-end	4.75	5.0	5.25	V
V _{DDD(1,2,3)}	digital supply voltage front-end	4.75	5.0	5.25	V
V _{DDA(4,5)}	analog supply voltage back-end	3.15	3.3	3.45	V
V _{DDD(4,5,6)}	digital supply voltage back-end	3.15	3.3	3.45	V
V _{DDIO}	I/O supply voltage back-end	4.75	5.0	5.25	V
I _{DDA(1,2,3)}	analog supply current front-end	–	85	100	mA
I _{DDD(1,2,3)}	digital supply current front-end	–	65	80	mA
I _{DDA(4,5)}	analog supply current back-end	–	25	35	mA
I _{DDD(4,5,6)}	digital supply current back-end	–	40	55	mA
I _{DDIO}	I/O supply current back-end	–	1	10	mA
P _{tot}	total power dissipation	–	–	1.3	W
T _{amb}	operating ambient temperature	–20	–	+60	°C

4 ORDERING INFORMATION

TYPE NUMBER	PACKAGE		
	NAME	DESCRIPTION	VERSION
SAA4977H	QFP80	plastic quad flat package; 80 leads (lead length 1.95 mm); body 14 × 20 × 2.8 mm	SOT318-2

Basic

SAA4977H

5 BLOCK DIAGRAM

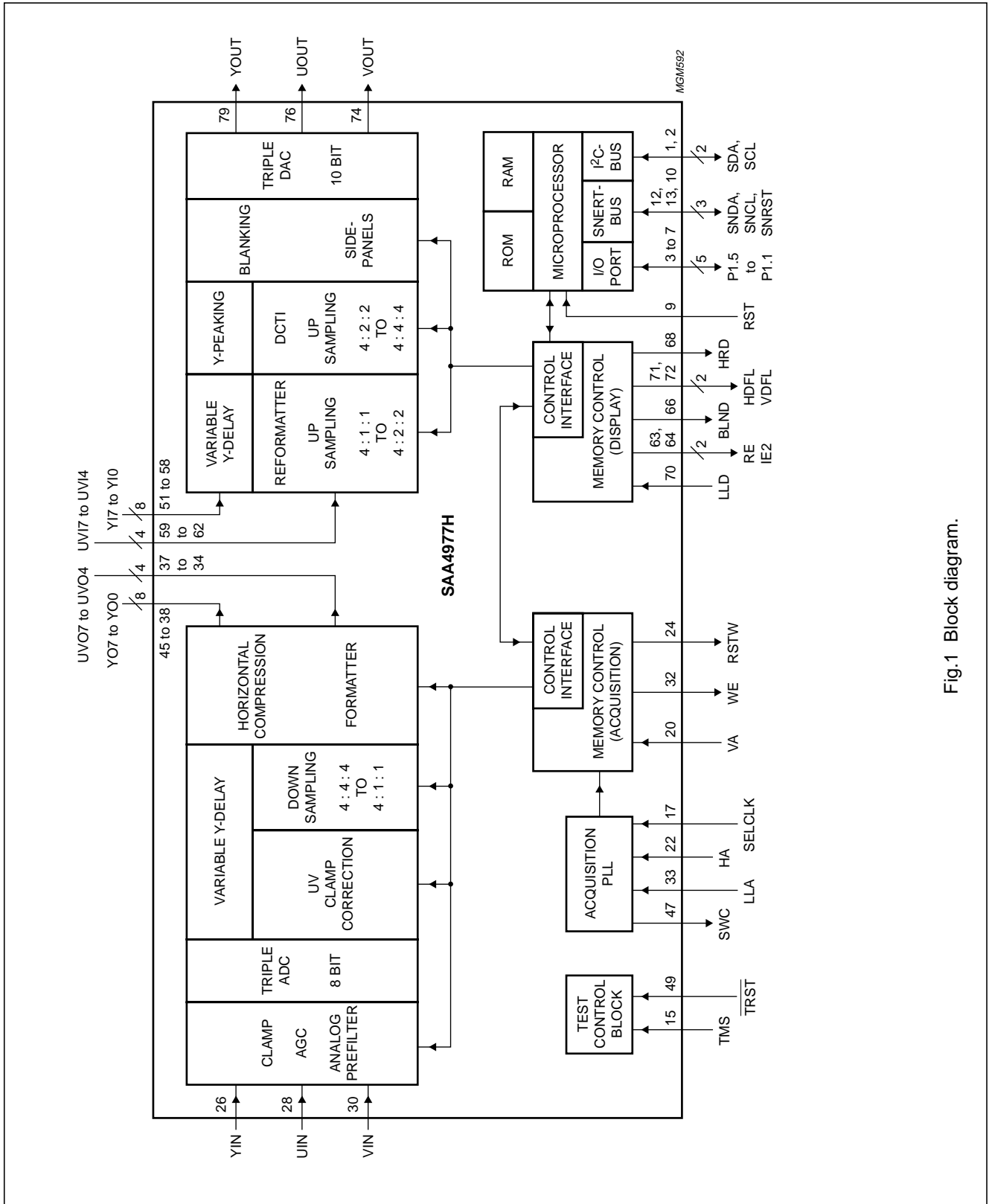

Fig.1 Block diagram.

Basic

SAA4977H

6 PINNING INFORMATION

6.1 Pinning

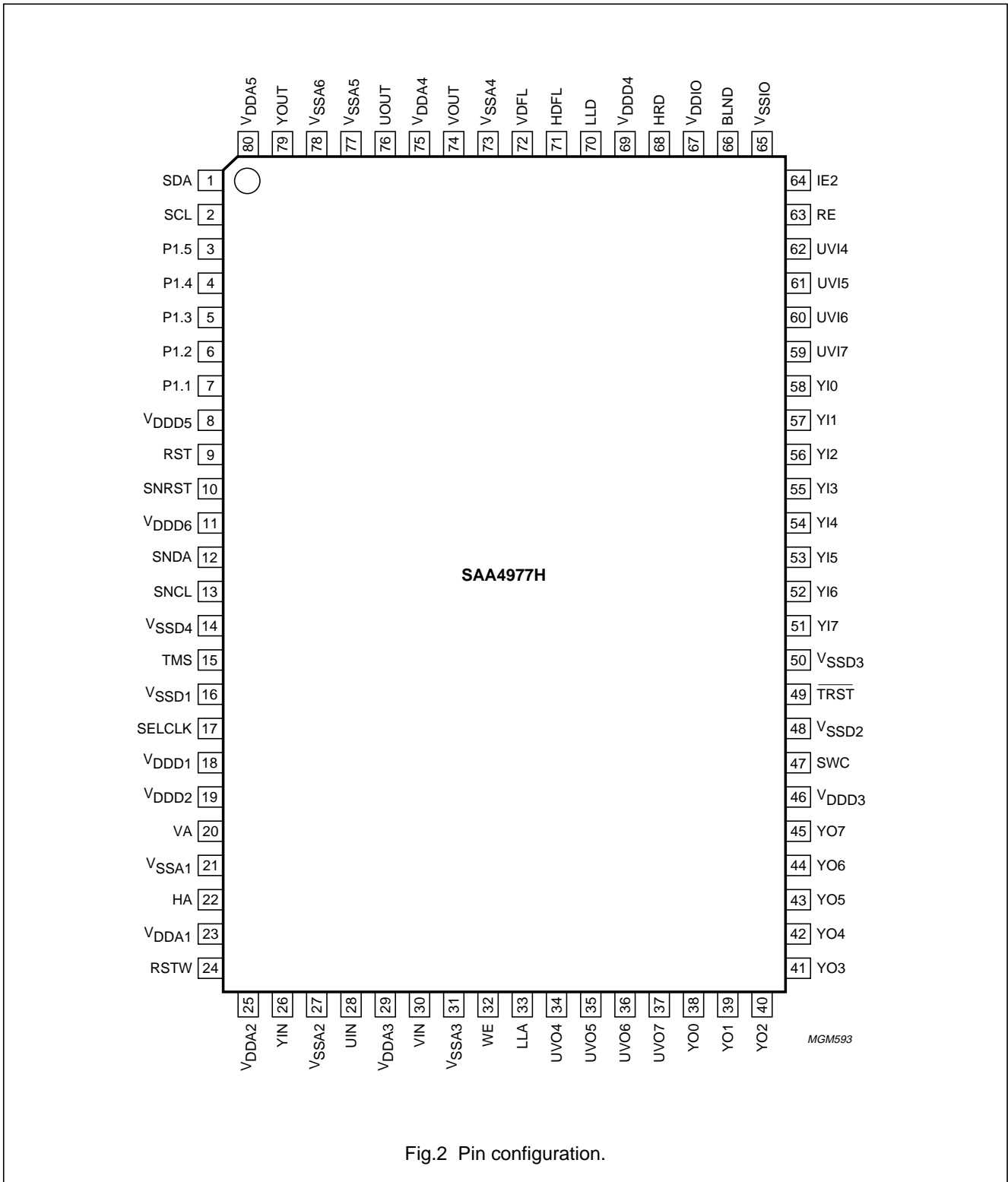

Fig.2 Pin configuration.

Basic

SAA4977H

6.2 Pin description

Table 1 QFP80 package

SYMBOL	PIN	DESCRIPTION
SDA	1	I ² C-bus serial data (P1.7)
SCL	2	I ² C-bus serial clock (P1.6)
P1.5	3	Port 1 data input/output signal 5
P1.4	4	Port 1 data input/output signal 4
P1.3	5	Port 1 data input/output signal 3
P1.2	6	Port 1 data input/output signal 2
P1.1	7	Port 1 data input/output signal 1
V _{DD5}	8	digital supply voltage 5 (3.3 V)
RST	9	microprocessor reset input
SNRST	10	SNERT restart (port 1.0)
V _{DD6}	11	digital supply voltage 6 (3.3 V)
SNDA	12	SNERT data
SNCL	13	SNERT clock
V _{SS4}	14	digital ground 4
TMS	15	test mode select
V _{SS1}	16	digital ground 1
SELCLK	17	select acquisition clock input; internal PLL if HIGH, external clock if LOW
V _{DD1}	18	digital supply voltage 1 (5 V)
V _{DD2}	19	digital supply voltage 2 (5 V)
VA	20	vertical synchronization input, acquisition part
V _{SSA1}	21	analog ground 1
HA	22	analog/digital horizontal reference input
V _{DDA1}	23	analog supply voltage 1 (5 V)
RSTW	24	reset write signal output, memory 1
V _{DDA2}	25	analog supply voltage 2 (5 V)
YIN	26	Y analog input
V _{SSA2}	27	analog ground 2
UIN	28	U analog input
V _{DDA3}	29	analog supply voltage 3 (5 V)
VIN	30	V analog input
V _{SSA3}	31	analog ground 3
WE	32	write enable signal output, memory 1
LLA	33	acquisition clock input
UVO4	34	V digital output bit 0
UVO5	35	V digital output bit 1
UVO6	36	U digital output bit 0
UVO7	37	U digital output bit 1
YO0	38	Y digital output bit 0

Basic

SAA4977H

SYMBOL	PIN	DESCRIPTION
YO1	39	Y digital output bit 1
YO2	40	Y digital output bit 2
YO3	41	Y digital output bit 3
YO4	42	Y digital output bit 4
YO5	43	Y digital output bit 5
YO6	44	Y digital output bit 6
YO7	45	Y digital output bit 7 (MSB)
V _{DDD3}	46	digital supply voltage 3 (5 V)
SWC	47	serial write clock output
V _{SSD2}	48	digital ground 2
$\overline{\text{TRST}}$	49	test reset, active LOW
V _{SSD3}	50	digital ground 3
YI7	51	Y digital input bit 7 (MSB)
YI6	52	Y digital input bit 6
YI5	53	Y digital input bit 5
YI4	54	Y digital input bit 4
YI3	55	Y digital input bit 3
YI2	56	Y digital input bit 2
YI1	57	Y digital input bit 1
YI0	58	Y digital input bit 0
UVI7	59	U digital input bit 1
UVI6	60	U digital input bit 0
UVI5	61	V digital input bit 1
UVI4	62	V digital input bit 0
RE	63	read enable signal output, memory 1
IE2	64	input enable signal output, memory 2
V _{SSIO}	65	I/O ground
BLND	66	horizontal blanking signal output, display part
V _{DDIO}	67	I/O supply voltage (5 V)
HRD	68	horizontal reference signal output, deflection part
V _{DDD4}	69	digital supply voltage 4 (3.3 V)
LLD	70	display clock input
HDFL	71	horizontal synchronization signal output, deflection part
VDFL	72	vertical synchronization signal output, deflection part
V _{SSA4}	73	analog ground 4
VOUT	74	V analog output
V _{DDA4}	75	analog supply voltage 4 (3.3 V)
UOUT	76	U analog output
V _{SSA5}	77	analog ground 5

Besic

SAA4977H

SYMBOL	PIN	DESCRIPTION
V _{SSA6}	78	analog ground 6
YOUT	79	Y analog output
V _{DDA5}	80	analog supply voltage 5 (3.3 V)

7 FUNCTIONAL DESCRIPTION

7.1 Analog-to-digital conversion

7.1.1 CLAMP CIRCUIT, CLAMPING Y TO DIGITAL LEVEL 16 AND UV TO 0 (2'S COMPLEMENT)

A clamp circuit is applied for each input channel, to map the colourless black level in each video line (on the sync back porch) to level 16 for Y and to the centre level of the converters for U and V. During the clamp period, an internally generated clamp pulse is used to switch on the clamp action. An operational transconductance amplifier like construction, which references to voltage reference points in the ladders of the ADCs, will provide a current on the input of the YUV signals, in order to bring the signals to the correct DC value. This current is proportional to the DC error, but is limited to $\pm 100 \mu\text{A}$. When the clamping action is off, the residual clamp current should be very low in order not to drift away within a video line.

7.1.2 GAIN ELEMENTS FOR AUTOMATIC GAIN CONTROL

A variable amplifier is used to map the possible YUV input range to the ADC range. A rise of 6 dB up to a drop fall of 6 dB w.r.t. the nominal values can be achieved. The gain setting within this range is done digitally via control registers. For this purpose a gain setting DAC is incorporated. The smallest step in the gain setting should be hardly visible on the picture, which can be met with smallest steps of 0.4%/step.

Luminance and chrominance gain settings can be separately controlled. The reason for this split is that U and V may be gain adjusted already, whereas luminance is to be adjusted by the SAA4977H AGC. On the other hand, for RGB originated sources, Y, U and V should be adjusted with the same AGC gain.

7.1.3 ANALOG ANTI-ALIASING PREFILTERING

A third order linear phase filter is applied on each of the Y, U and V channels. It provides a notch on f_{CLK} (16 MHz) to strongly prevent aliasing to low frequencies, which would be the most disturbing. The bandwidth of the filters is designed for -3 dB at 5.6 MHz. The filters can be bypassed if external filtering with other characteristics is desired.

7.1.4 TRIPLE 8-BIT ANALOG-TO-DIGITAL CONVERSION

Three identical ADCs are used to convert Y, U and V with 16 MHz data rate. A multi-step type ADC is applied here.

7.2 Digital processing at $1f_H$ level

7.2.1 OVERLOAD DETECTION

The overload detection provides information to make efficient use of the AGC. The number of overflows per video field in the luminance channel is accumulated by a 14-bit counter. The 8 MSBs of this counter can be read out by the microprocessor respectively via the I²C-bus. Overflow levels can be programmed as 216, 224, 232 and 240.

7.2.2 DIGITAL CLAMP CORRECTION FOR UV

During 32 samples within the clamp position the clamp error is measured and accumulated to make a low-pass filtered value of the clamp error. Then a vertical recursive filter is used to further low-pass this error value. This value can be read by the microprocessor or directly be used to correct the clamp error. It is also possible to give a fixed correction value by the microprocessor.

7.2.3 4 : 4 : 4 TO 4 : 1 : 1 DOWN-SAMPLING AND UV CORING

The U and V samples from the ADC are low-pass filtered, before being subsampled with a factor of 2. Coring is applied to the subsampled signal to obtain no gain for low amplitudes which is considered to be noise. Coring levels can be programmed as 0 (off), $\pm 1/2$, ± 1 and ± 2 LSB.

The U and V samples from the 4 : 2 : 2 data are low-pass filtered again, before being subsampled a second time with a factor of 2 and formatted to 4 : 1 : 1 format.

7.2.4 Y-DELAY

The Y samples can be shifted onto 8 positions w.r.t. the UV samples. This shift is meant to account for a possible difference in delay previous to the SAA4977H. The zero delay setting is suitable for the nominal case of aligned input data according to the interface format standard. The other settings provide four samples less delay to three sample more delay in Y.

Basic

SAA4977H

7.2.5 HORIZONTAL COMPRESSION

For displaying 4 : 3 sources on 16 : 9 screens a horizontal signal compression can be done by data interpolation. Therefore two horizontal compression factors of either $\frac{4}{3}$ or $\frac{7}{6}$ are possible. Via the I²C-bus the compression can be switched on or off and the compression mode 16 : 9 or 14 : 9 can be selected. When the compression mode is active, a reduced number of the interpolated data is stored in the field memory. To achieve sufficiently high accuracy in interpolation Variable Phase Delay filters are used (VPD10 for luminance, a multiplexed VPD06 for UV).

7.3 Digital processing at 2f_H level

7.3.1 4 : 1 : 1 TO 4 : 2 : 2 UP-CONVERSION

An up-converter to 4 : 2 : 2 is applied with a linear interpolation filter for creation of the extra samples. These are combined with the original samples from the 4 : 1 : 1 stream.

7.3.2 DCTI

The Digital Colour Transient Improvement (DCTI) is intended for U and V signals originating from a 4 : 1 : 1 source. Horizontal transients are detected and enhanced without overshoots by differentiating, make absolute and again differentiating the U and V signals separately.

This results in a 4 : 4 : 4 U and V bandwidth. To prevent third harmonic distortion, typical for this processing, a so called over the hill protection prevents peak signals becoming distorted. Via the I²C-bus it is possible to control: gain width (see Fig.4), threshold (i.e. immunity against noise), selection of simple or improved first differentiating filter (see Fig.3), limit for pixel shift range (see Fig.5), common or separate processing of U and V signals, hill protection mode (i.e. no discolourations in narrow colour gaps), low-pass filtering for U and V signals (see Fig.6) and a so called super hill mode, which avoids discolourations in transients within a colour component.

7.3.3 Y-PEAKING

A linear peaking is applied, which amplifies the luminance signal in the middle and the upper ranges of the bandwidth.

The filtering is an addition of:

- The original signal
- The original signal high-passed with maximum gain at frequency = $\frac{1}{2}f_s$ (8 MHz)
- The original signal band-passed with centre frequency = $\frac{1}{4}f_s$ (4 MHz)

- The original signal band-passed with centre frequency of 2.38 MHz.

The band-passed and high-passed signals are weighted with factors 0, $\frac{1}{16}$, $\frac{2}{16}$, $\frac{3}{16}$, $\frac{4}{16}$, $\frac{5}{16}$, $\frac{6}{16}$, and $\frac{8}{16}$, resulting in a maximum gain difference of 2 dB at the centre frequencies.

Coring is added to obtain no gain for low amplitudes in the high-pass and band-pass filtered signal, which is considered to be noise. Coring levels can be programmed as 0 (off), ± 8 , ± 16 , ± 24 to ± 120 LSB w.r.t. the (signed) 11-bit filtered signal.

In addition the peaking gain can be reduced depending on the signal amplitude, programming range 0 (no attenuation), $\frac{1}{4}$, $\frac{2}{4}$, and $\frac{4}{4}$. It is also possible to make larger undershoots than overshoots, programming range 0 (no attenuation of undershoots), $\frac{1}{4}$, $\frac{2}{4}$, and $\frac{4}{4}$.

7.3.4 Y-DELAY

The Y samples can be shifted onto 8 positions w.r.t. the UV samples. This shift is meant to account for a possible difference in delay previous to the SAA4977H. The zero delay setting is suitable for the nominal case of aligned input data. The other settings provide one to seven samples less delay in Y.

7.3.5 SIDEPANELS AND BLANKING

Sidepanels are generated by switching Y and the 4 MSBs of U and V to certain programmable values. The start and stop values for the sidepanels w.r.t. the rising edge of the HRD signal are programmable in a resolution of 4 LLD clock cycles. In addition, a fine shift of 0 to 3 LLD clock cycles of both values can be achieved.

Blanking is done by switching Y to value 64 at 10-bit word and UV to value 0 (in 2's complement). Blanking is controlled by a composite signal HVBDA, consisting of a horizontal part HBDA and a vertical part VBDA. Set and reset value of the horizontal control signal HBDA are programmable w.r.t. the rising edge of the HRD signal, set and reset value of the vertical control signal VBDA are programmable w.r.t. the rising edge of the VA signal.

The range of the Y output signal can be selected between 9 and 10 bits. In the case of 9 bits for the nominal signal there is room left for undershoot and overshoot (adding up to a total of 10 bits). In the case of selecting all 10 bits of the luminance DAC for the nominal signal any under or overshoot will be clipped (see Fig.11).

Basic

SAA4977H

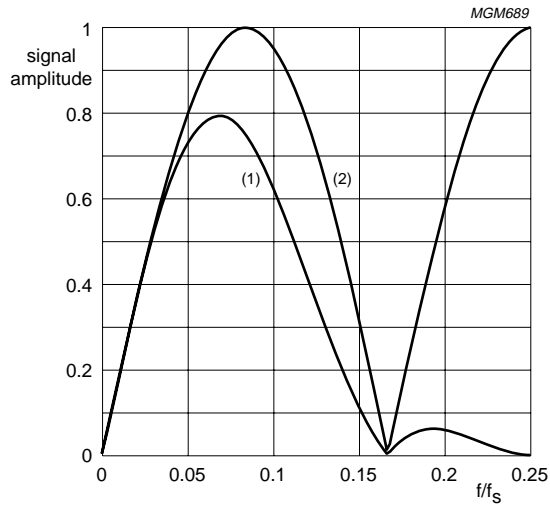

- (1) dcti_ddx_sel = 1.
- (2) dcti_ddx_sel = 0.

Fig.3 DCTI first differentiating filter; transfer function with variation of control signal dcti_ddx_sel.

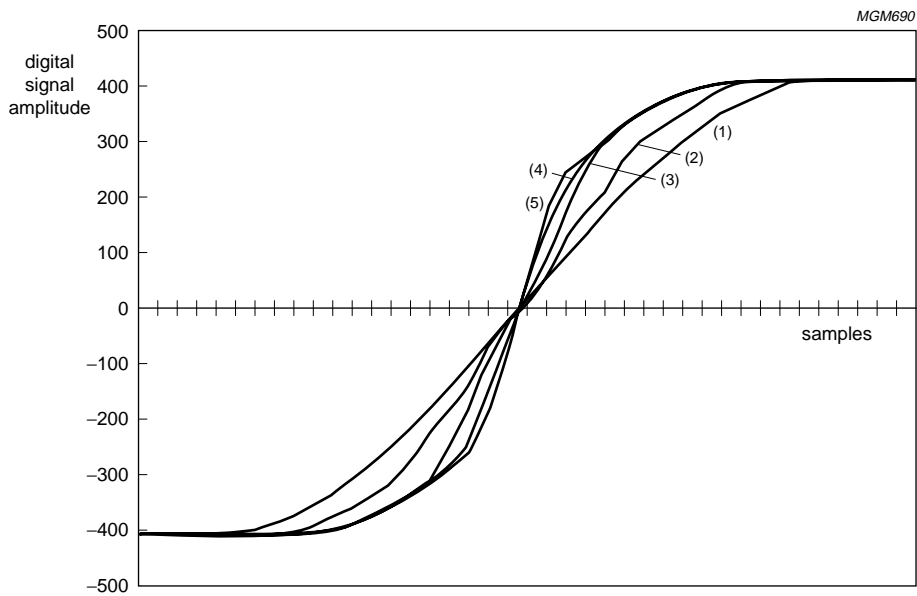

- (1) input signal.
- (2) gain = 1.
- (3) gain = 3.
- (4) gain = 5.
- (5) gain = 7.

Fig.4 DCTI with variation of gain setting (limit = 1).

Basic

SAA4977H

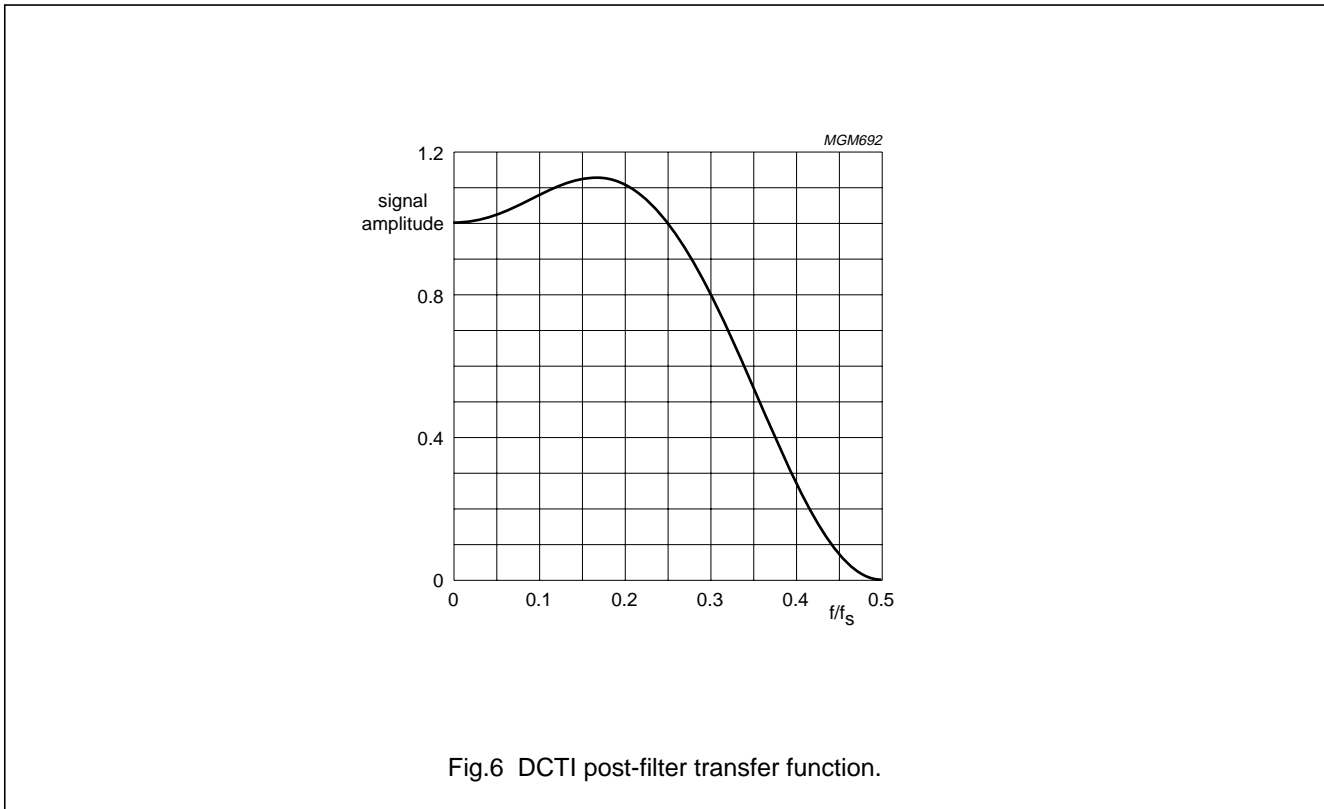
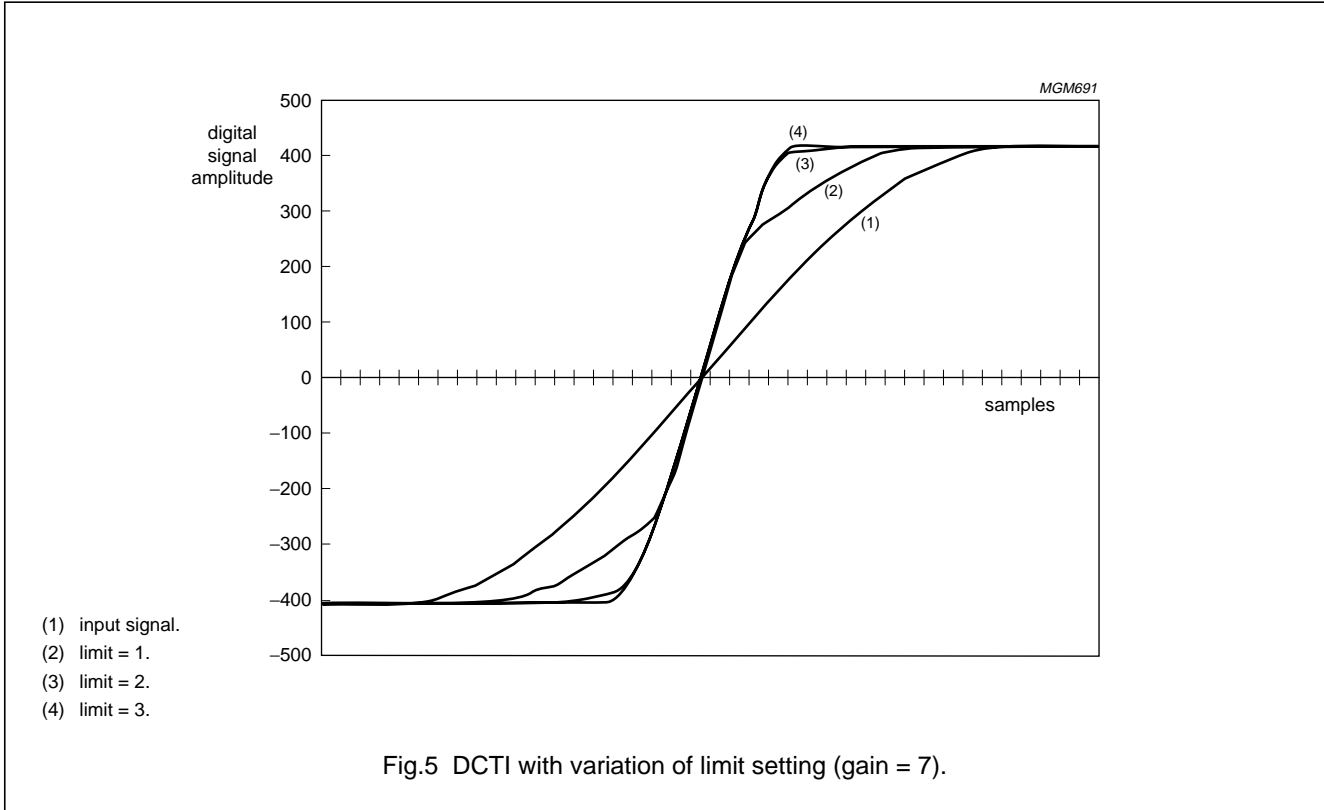

Basic

SAA4977H

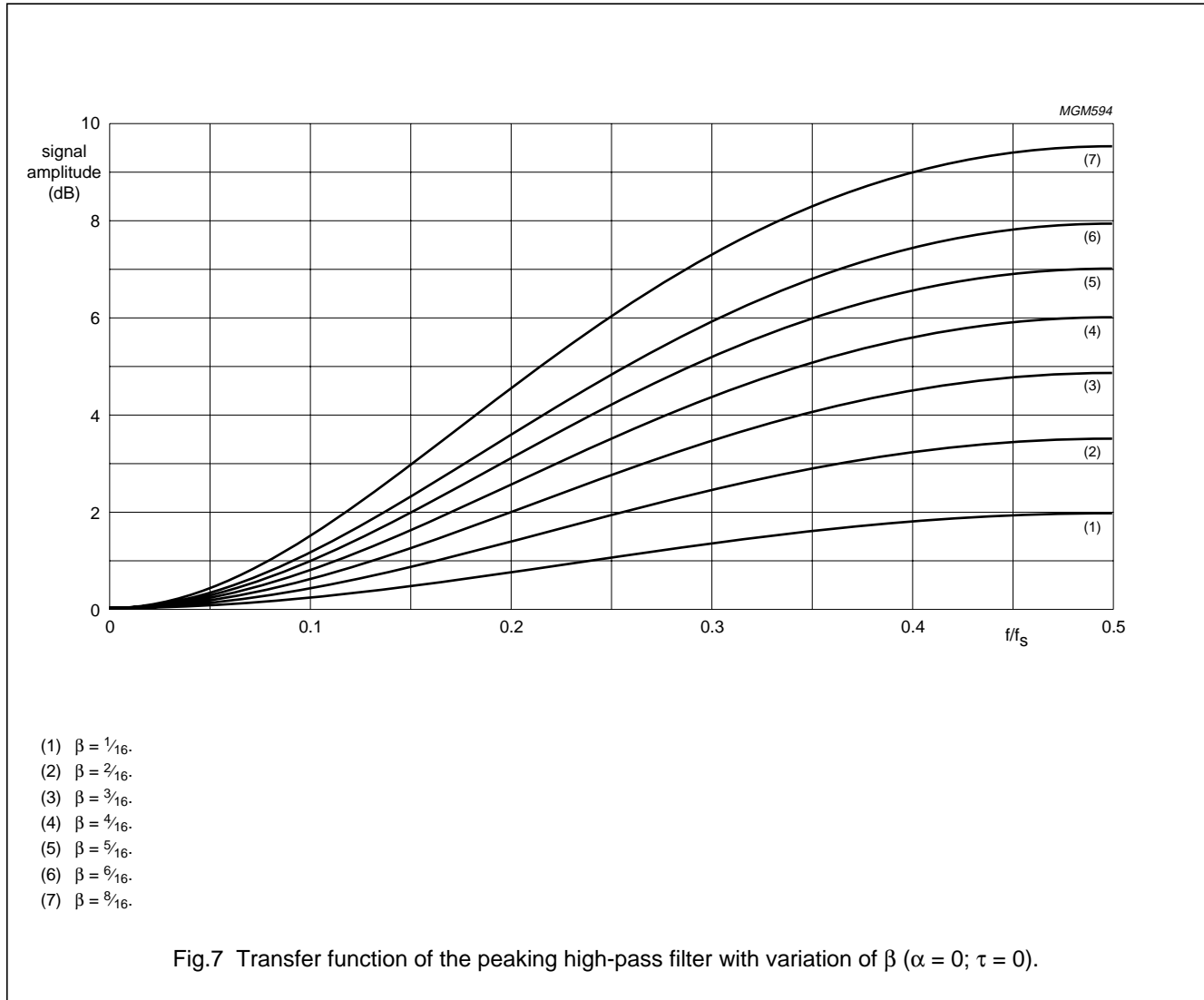

Basic

SAA4977H

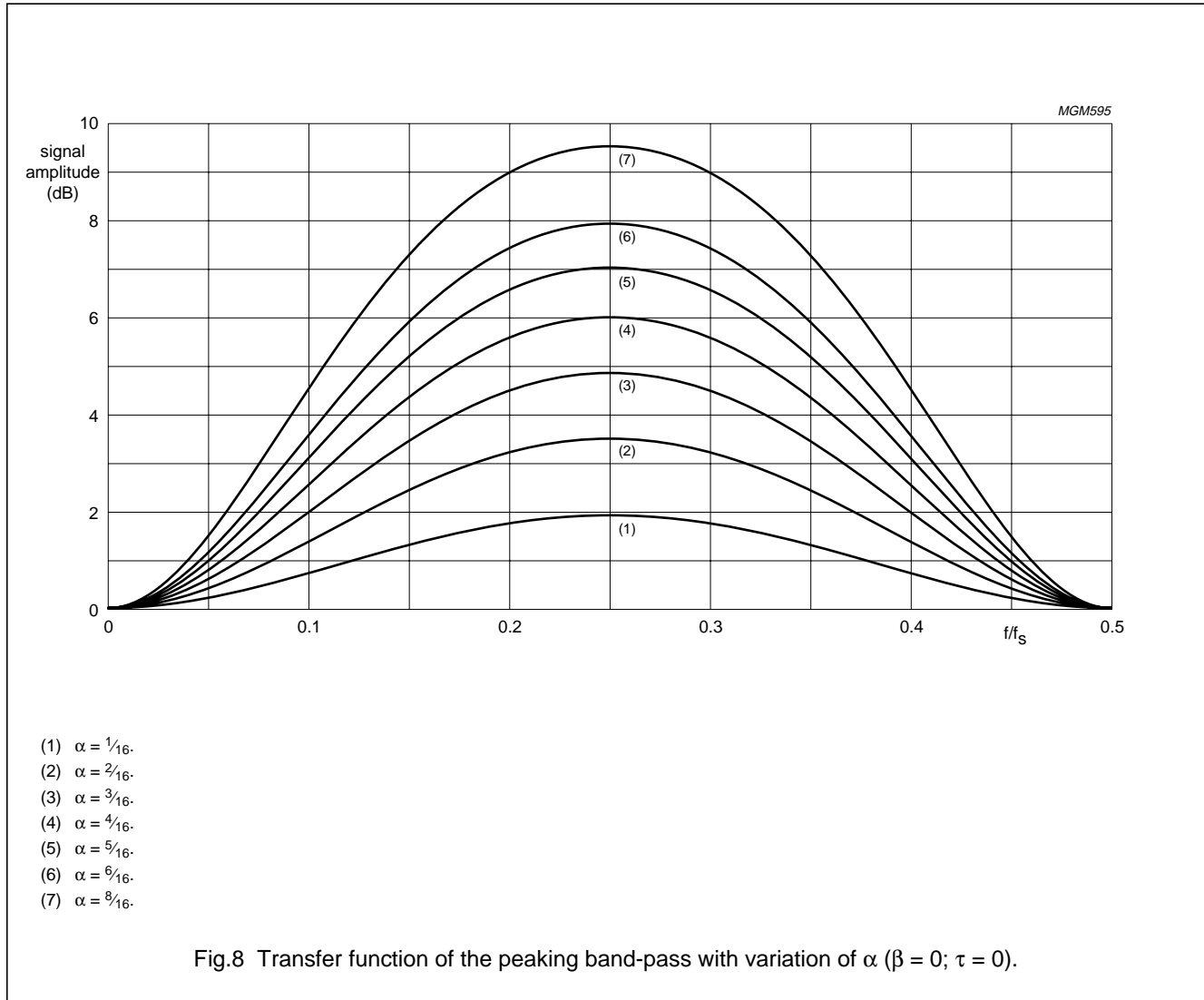

Basic

SAA4977H

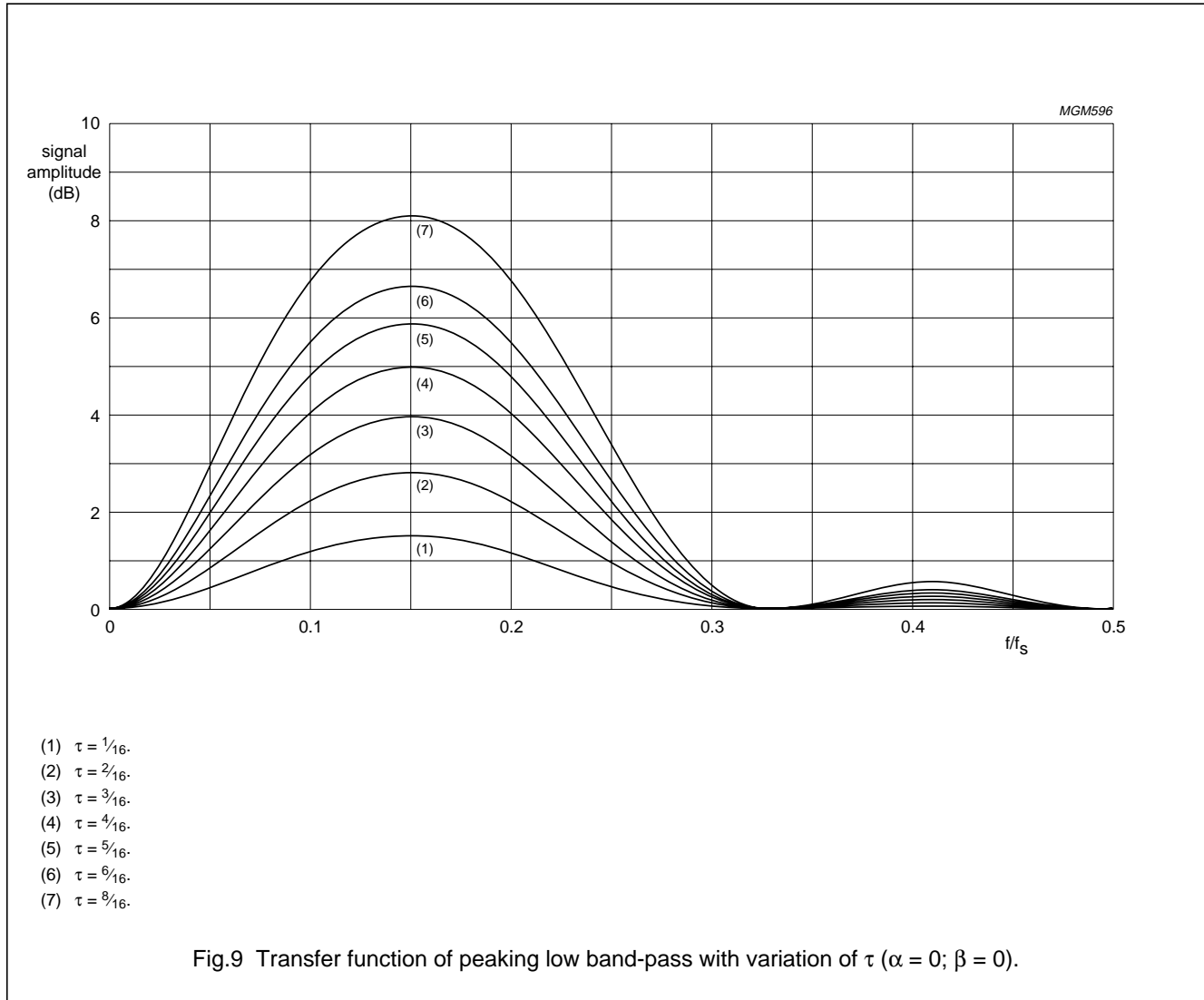

Basic

SAA4977H

7.4 Digital-to-analog conversion

Three identical 10-bit DACs are used to map the 4 : 4 : 4 data to analog levels.

7.5 Microprocessor

The SAA4977H contains an embedded 80C51 microprocessor core including a 256 byte RAM and 16 kbyte ROM. The microprocessor runs on a 16 MHz clock, generated by dividing the 32 MHz display clock by a factor of 2. For controlling internal registers a host interface, consisting of a parallel address and data bus, is built-in, that can be addressed as internal AUX RAM via MOVX type of instructions.

7.5.1 I²C-BUS

The I²C-bus interface in the SAA4977H is used in a slave receive and transmit mode for communication with a central system microprocessor. The standardized bus frequencies of both 100 kHz and 400 kHz can be dealt with.

The I²C-bus slave address of the SAA4977H is 0110100 R/W.

For a detailed description of the transmission protocol refer to brochure "*The I²C-bus and how to use it*" (order number 9398 393 40011) and to Application note "*I²C-bus register specification of the SAA4977H*" (AN98054).

7.5.2 SNERT-BUS

A SNERT interface is built-in, which operates in a master receive and transmit mode for communication with peripheral circuits such as the SAA4990H or SAA4991WP. The SNERT interface replaces the standard UART interface. In contrast to the 80C51 UART interface there are additional special function registers and there is no byte separation time between address and data.

The SNERT interface transforms the parallel data from the microprocessor into 1 Mbaud SNERT data. The SNERT-bus consists of three signals: SNCL used as the serial clock signal and is generated by the SNERT interface; SNDA used as the bidirectional data line, and SNRST used as the reset signal and is generated by the microprocessor to indicate the start of a transmission.

The read or write operation must be set by the microprocessor. When writing to the bus, 2 bytes are loaded by the microprocessor: one for the address, the other for the data.

When reading from the bus, one byte is loaded by the microprocessor for the address, the received byte is the data from the addressed SNERT location.

7.5.3 I/O PORTS

A parallel 8-bit I/O port (P1) is available, where P1.0 is used as the SNERT reset signal (SNRST), P1.1 to P1.5 can be used for application specific control signals, and P1.6 and P1.7 are used as I²C-bus signals (SCL and SDA).

7.5.4 WATCHDOG TIMER

The microprocessor contains an internal Watchdog Timer, which can be activated by setting the bit 4 in SFR PCON. Only a synchronous reset will clear this bit. To prevent a system reset the Watchdog Timer must be reloaded in time. The Watchdog Timer is incremented every 0.75 ms. The time interval between the timer's reloading and the occurrence of a reset depends on the reloaded 8-bit value.

7.6 Memory controller

The memory controller provides all necessary acquisition clock related write signals (WE and RSTW) and display clock related read signals (RE and IE2) to control one or two-field memory concepts. Furthermore the drive signals (HDFL and VDFL) for the horizontal and vertical deflection power stages are generated. Also a horizontal blanking pulse BLND is generated which can be used for peripheral circuits as SAA4990H. The memory controller is connected to the microprocessor via the host interface. Start and stop values for all pulses, referring to the corresponding horizontal or vertical reference signal, are programmable under control of the internal software. To allow user access to these control signals via the I²C-bus a range of subaddresses is reserved; for a detailed description of this user interface refer to Application Note "*I²C-bus register specification of the SAA4977H*" (AN98054).

7.6.1 WE

The write enable signal for field memory 1 is a composite signal consisting of a horizontal and a vertical part. The horizontal position w.r.t the rising edge of the HA signal and the vertical position w.r.t the rising edge of the VA signal are programmable.

Basic
SAA4977H

7.6.2 RSTW

Reset write signal for field memory 1; this signal is derived from the positive edge of the VA input signal and has a pulse width of 64 μ s.

7.6.3 RE

The read enable signal for field memory 1 is a composite signal consisting of a horizontal and a vertical part. The horizontal position w.r.t the rising edge of the HA signal and the vertical position w.r.t the rising edge of the VA signal are programmable.

7.6.4 IE2

Input enable signal for field memory 2, can be directly set or reset by the microprocessor.

7.6.5 HDFL

Horizontal deflection signal for driving a deflection circuit; this signal has a cycle time of 32 μ s and a pulse width of 76 LLD clock cycles.

7.6.6 VDFL

Vertical deflection signal for driving a deflection circuit; this signal has a cycle time of 10 ms; the start and stop value w.r.t the rising edge of the VA signal is programmable in steps of 16 μ s.

7.6.7 BLND

Horizontal blanking signal for peripheral circuits e.g. SAA4990H, start and stop values w.r.t. the rising edge of HRD are programmable.

7.7 Line locked clock generation**7.7.1 PHASE COMPARISON OF HA RISING EDGE WITH GENERATED H_{ref} SIGNAL**

The HA signal, which has a nominal period of 64 μ s, is used as a timing reference for the line locked acquisition clock system. This HA signal may vary in position from application to application, related to the active video part. The phase comparator measures the delay between the HA and the internally generated, clock synchronous H_{ref} signal.

7.7.2 PLL CLOCK GENERATOR RUNNING AT 32 MHz (2048 CLOCK CYCLES PER LINE)

The basic frequency of the clock generator is 32 MHz. The type of PLL is known as 'Petra PLL'. This is a purely analog clock generator, with analog frequency control via a loop filter on the measured phase error.

7.7.3 DIVIDE-BY-2 FOR MASTER CLOCK 16 MHz

A simple clock divider is used to generate 16 MHz out of 32 MHz. The advantage of this construction is the inherent 50% duty cycle on the acquisition clock.

7.7.4 DIVIDE BY ANOTHER 1024 TO GENERATE LINE FREQUENT, CLOCK SYNCHRONOUS H_{ref} SIGNAL

The video lines contain 1024 clock cycles of 16 MHz. Therefore, frequency division by 1024 creates a 50% duty cycle line frequent signal H_{ref} .

7.8 Clock and sync interfacing

Typically the circuit operates as a two clock system, i.e. LLA is supplied with a 16 MHz clock and LLD with a 32 MHz clock.

The line locked display clock LLD must be provided by the application. Also a line frequent signal must be provided by the application at pin HA. A vertical 50 or 60 Hz synchronization signal has to be applied on pin VA.

It is also possible to use an external line locked acquisition clock, which must be provided at pin LLA. This operation mode can be selected by the SELCLK pin. When using the external acquisition clock the HA signal must be synchronous to the acquisition clock.

A display clock synchronous line frequent signal is put out at pin HRD providing a duty factor of 50%. The rising edge of HRD is also the reference for display related control signals as BLND, RE, HDAV and HBDA.

The acquisition clock is buffered internally and put out as serial write clock (SWC) for supplying the field memory.

Basic

SAA4977H

7.9 4 : 1 : 1 I/O interfacing**Table 2** Digital input and output bus format

OUTPUT PIN	4 : 1 : 1 FORMAT				INPUT PIN
	Y07	Y17	Y27	Y37	
YO7	Y07	Y17	Y27	Y37	YI7
YO6	Y06	Y16	Y26	Y36	YI6
YO5	Y05	Y15	Y25	Y35	YI5
YO4	Y04	Y14	Y24	Y34	YI4
YO3	Y03	Y13	Y23	Y33	YI3
YO2	Y02	Y12	Y22	Y32	YI2
YO1	Y01	Y11	Y21	Y31	YI1
YO0	Y00	Y10	Y20	Y30	YI0
UVO7	U07	U05	U03	U01	UVI7
UVO6	U06	U04	U02	U00	UVI6
UVO5	V07	V05	V03	V01	UVI5
UVO4	V06	V04	V02	V00	UVI4

The first phase of the 4 : 1 : 1 YUV dataword is available on the output bus one SWC clock cycle after the rising edge of the WE signal. The start position, when the first phase of the 4 : 1 : 1 YUV data word is expected on the input bus, can be defined by the internal control signal HDAV.

The luminance output signal is in 8-bit straight binary format, whereas U and V input signals are in 2's complement format. Also the luminance input signal is expected in 8-bit straight binary format, whereas U and V input signals are expected in 2's complement format. The U and V input signals are inverted if the corresponding control bit uv_inv is set via the I²C-bus.

7.10 Test mode operation

The SAA4977H provides a test mode function which should not be entered by the customer. If the $\overline{\text{TRST}}$ input is driven HIGH, different test modes can be selected by applying a HIGH to the TMS input for a defined number of LLD clock cycles. To exit the test mode TMS and $\overline{\text{TRST}}$ must be driven LOW.

Basic

SAA4977H

7.11 I²C-bus control registers

ADDRESS	BIT	NAME	DESCRIPTION
Subaddress 00H to 2FH: reserved; note 1			
Subaddress 30H to 32H (AGC)			
30H	0 to 7	AGC_Y	AGC gain for Y channel (2's complement relative to 0 dB): upper 8 bits
31H	0 to 7	AGC_UV	AGC gain for U and V channel (2's complement relative to 0 dB): upper 8 bits
32H	0	AGC_Y	AGC gain for Y channel LSB
	1	AGC_UV	AGC gain for UV channel LSB
	2	standby_f	front-end in standby mode if HIGH
	3	aaf_bypass	bypass for prefilter if HIGH
	4 to 7	–	reserved
Subaddress 33H (UV clamp correction)			
33H	0 and 1	UVclcor_mode	clamp correction mode = auto, fixed, keep, reserved
	2 to 4	Uclcor_fval	fixed value for clamp correction U channel
	5 to 7	Vclcor_fval	fixed value for clamp correction V channel
Subaddress 34H (UV coring)			
34H	0 and 1	UVcoring	coring level = 0, ± 0.5 , ± 1 and ± 2 LSB
	2 and 3	–	reserved
	4 and 5	UVcl_tau	vertical filtering of measured clamp
	6 and 7	–	reserved
Subaddress 35H (Y delay)			
35H	0 to 2	ydelay_f	variable Y-delay in LLA clock cycles: -4, -3, -2, -1, 0, 1, 2 and 3
	3 and 4	overl_thr	overload threshold: (216, 224, 232, 240)
	5	fill_mem	fill memory with constant value if HIGH
	6 and 7	–	reserved
Subaddress 36H and 37H (DCTI)			
36H	0 to 2	dcti_gain	DCTI gain: 0, 1, 2, 3, 4, 5, 6 and 7
	3 to 6	dcti_threshold	DCTI threshold: 0, 1 to 15
	7	dcti_ddx_sel	DCTI selection of first differentiating filter; see Fig.3
37H	0 and 1	dcti_limit	DCTI limit for pixel shift range: 0, 1, 2 and 3
	2	dcti_separate	DCTI separate processing of U and V signals; 0 = off, 1 = on
	3	dcti_protection	DCTI over the hill protection; 0 = off, 1 = on
	4	dcti_filteron	DCTI post-filter; 0 = off, 1 = on
	5	dcti_superhill	DCTI super hill mode; 0 = off, 1 = on
	6 and 7	–	reserved
Subaddress 38H and 3AH (peaking)			
38H	0 to 2	pk_alpha	peaking alpha: $\frac{1}{16}$ (0, 1, 2, 3, 4, 5, 6, 8)
	3 to 5	pk_beta	peaking beta: $\frac{1}{16}$ (0, 1, 2, 3, 4, 5, 6, 8)
	6 and 7	–	reserved

Basic

SAA4977H

ADDRESS	BIT	NAME	DESCRIPTION
39H	0 to 2	pk_tau	peaking tau: $\frac{1}{16}$ (0, 1, 2, 3, 4, 5, 6, 8)
	3 and 4	pk_delta	peaking amplitude dependent attenuation: $\frac{1}{4}$ (0, 1, 2, 4)
	5 and 6	pk_neggain	peaking attenuation of undershoots: $\frac{1}{4}$ (0, 1, 2, 4)
	7	–	reserved
3AH	0 to 3	pk_corthr	peaking coring threshold 0, ± 8 , ± 16 to ± 120 LSB
	4 to 7	–	reserved
Subaddress 3BH and 3CH (sidepanels overlay)			
3BH	0 to 3	overlay_u	sidepanels overlay U (4 MSB)
	4 to 7	overlay_v	sidepanels overlay V (4 MSB)
3CH	0 to 7	overlay_y	sidepanels overlay Y (8 MSB)
Subaddress 3DH to 3FH (sidepanel position)			
3DH	0 to 7	sidepanel_start	sidepanel start position (8 MSB) w.r.t. the rising edge of HRD signal
3EH	0 to 7	sidepanel_stop	sidepanel stop position (8 MSB) w.r.t. the rising edge of HRD signal
3FH	0 and 1	sidepanel_fdel	fine delay of sidepanel signal in LLD clock cycles: 0, 1, 2 and 3
	2	output_range	output range (output range = 0: 9 bit for the nominal output signal, black level: 288 and white level: 767; output range = 1: 10 bit for the nominal output signal, black level 64 and white level 1023)
	3	uv_inv	inverts UV input signals: 0 = no inversion, 1 = inversion
	4 to 6	ydelay_out	variable Y-delay in LLD clock cycles: -7, -6, -5, -4, -3, -2, -1 and 0
	7	–	reserved

Note

- Detailed information about the software dependent I²C-bus registers can be found in Application Note “I²C-bus register specification of the SAA4977H” (AN98054).

8 LIMITING VALUES

In accordance with the Absolute Maximum Rating System (IEC 134).

SYMBOL	PARAMETER	MIN.	MAX.	UNIT
V _{DDA(1,2,3)}	analog supply voltage front-end	-0.5	+5.25	V
V _{DDD(1,2,3)}	digital supply voltage front-end	-0.5	+5.25	V
V _{DDA(4,5)}	analog supply voltage back-end	-0.5	+3.45	V
V _{DDD(4,5,6)}	digital supply voltage back-end	-0.5	+3.45	V
V _{DDIO}	digital I/O supply voltage back-end	-0.5	+5.25	V
V _i	input voltage for all I/O pins	-0.5	+5.25	V
T _{stg}	storage temperature	-20	+150	°C
T _{amb}	operating ambient temperature	-20	+60	°C

9 THERMAL CHARACTERISTICS

SYMBOL	PARAMETER	CONDITIONS	VALUE	UNIT
R _{th(j-a)}	thermal resistance from junction to ambient	in free air	50	K/W

Besic

SAA4977H

10 CHARACTERISTICS

$V_{DDD(1,2,3)} = 4.75$ to 5.25 V; $V_{DDA(1,2,3)} = 4.75$ to 5.25 V; $V_{DD(4,5,6)} = 3.15$ to 3.45 V; $V_{DDA(4,5)} = 3.15$ to 3.45 V;
 $T_{amb} = 0$ to 60 °C; unless otherwise specified.

SYMBOL	PARAMETER	CONDITIONS	MIN.	TYP.	MAX.	UNIT
Supply						
$V_{DDA(1,2,3)}$	analog supply voltage front-end		4.75	5.0	5.25	V
$V_{DDD(1,2,3)}$	digital supply voltage front-end		4.75	5.0	5.25	V
$I_{DDA(1,2,3)}$	analog supply current front-end		–	85	100	mA
$I_{DDD(1,2,3)}$	digital supply current front-end		–	65	80	mA
$V_{DDA(4,5)}$	analog supply voltage back-end		3.15	3.3	3.45	V
$V_{DDD(4,5,6)}$	digital supply voltage back-end		3.15	3.3	3.45	V
V_{DDIO}	I/O supply voltage back-end		4.75	5.0	5.25	V
$I_{DDA(4,5)}$	analog supply current back-end		–	25	35	mA
$I_{DDD(4,5,6)}$	digital supply current back-end		–	40	55	mA
I_{DDIO}	I/O supply current back-end		–	1	10	mA
Dissipation						
P_{tot}	total power dissipation		–	–	1.3	W
Luminance input signal (Y clamp level digital 16)						
$V_{i(p-p)}$	Y input level (peak-to-peak value)	AGC fixed at 0 dB; note 1	0.95	1.00	1.05	V
C_i	input capacitance		–	7	15	pF
I_{LI}	input leakage current	clamp not active	–	–	100	nA
I_I	input current	during clamping	–	–	±150	µA
$\alpha_{AGC(max)}$	maximum AGC attenuation		5.75	6	–	dB
$G_{AGC(max)}$	maximum AGC gain		5.75	6	–	dB
$\alpha_{AGC(acc)}$	AGC attenuation accuracy digital		–	8	–	bits
$G_{AGC(acc)}$	AGC gain accuracy digital		–	8	–	bits
Colour difference input signals (U and V clamp level digital 128)						
$V_{i(p-p)}$	U input level (peak-to-peak value)	AGC fixed at 0 dB; note 1	1.29	1.34	1.39	V
	V input level (peak-to-peak value)	AGC fixed at 0 dB; note 1	1.00	1.05	1.10	V
C_i	input capacitance		–	–	15	pF
I_{LI}	input leakage current	clamp not active	–	–	100	nA
I_I	input current	during clamping	–	–	±150	µA
$\alpha_{AGC(max)}$	maximum AGC attenuation		5.75	6	–	dB
$G_{AGC(max)}$	maximum AGC gain		5.75	6	–	dB
$\alpha_{AGC(acc)}$	AGC attenuation accuracy digital		–	8	–	bits
$G_{AGC(acc)}$	AGC gain accuracy digital		–	8	–	bits

Basic

SAA4977H

SYMBOL	PARAMETER	CONDITIONS	MIN.	TYP.	MAX.	UNIT
Analog input transfer function (sample rate 16 MHz/8 bits)						
f_{CLK}	maximum sample clock		18	–	–	MHz
INL	integral non linearity	ramp input signal	–1	–	+1	LSB
DNL	differential non linearity	ramp input signal	–0.75	–	+0.75	LSB
S/N	signal-to-noise ratio	nominal amplitude; 0 to 8 MHz	43	–	–	dB
HD	harmonic distortion (2nd to 5th harmonic)	95% amplitude; Y at 4.3 MHz; UV at 1 MHz	–	–50	–37	dB
G_{dif}	differential gain	$f_{\text{CLK}} = 4.4$ MHz; ADC only; at nominal AGC setting	–	1	2	%
SVR	supply voltage rejection	note 2	34	–	–	dB
Analog Y, U and V input filter (third order linear phase filter with notch at f_{CLK})						
$f_{(-3\text{dB})}$	3 dB down frequency	$f_{\text{CLK}} = 16$ MHz	5.4	5.6	5.8	MHz
$\alpha_{(0.5)}$	attenuation at $\frac{1}{2}f_{\text{CLK}}$ (8 MHz)		7	8	–	dB
α_{sb}	stop band attenuation		30	–	–	dB
f_{notch}	notch frequency		15.5	16	16.5	MHz
$t_{\text{d(g)}}$	group delay	$f_{\text{CLK}} = 4$ MHz	–	55	65	ns
$t_{\text{d(g)(dif)}}$	differential group delay within 1 to 6 MHz		–	20	30	ns
Luminance output signal (output_range = 0: Y black level digital 288, white level digital 767, output_range = 1: Y black level digital 64, white level digital 1023); see Fig.11						
$V_{\text{o(p-p)}}$	Y output level (peak-to-peak value)	$Z_{\text{L}} = 2$ k Ω	1.28	1.34	1.40	V
R_{o}	output resistance		–	50	100	Ω
R_{L}	resistive load		1	2	–	k Ω
C_{L}	capacitive load		–	–	25	pF
SVR	supply voltage rejection	note 2	34	–	–	dB
α_{ct}	crosstalk attenuation between outputs	0 to 10 MHz	40	–	–	dB
S/N	signal-to-noise ratio	nominal amplitude; 0 to 10 MHz	46	–	–	dB
Colour difference output signals (U and V digital range 0 to 1023)						
$V_{\text{o(p-p)}}$	U output level (peak-to-peak value)	$Z_{\text{L}} = 2$ k Ω	1.28	1.34	1.40	V
	V output level (peak-to-peak value)	$Z_{\text{L}} = 2$ k Ω	1.28	1.34	1.40	V
$G_{\text{m(U-V)}}$	gain matching U to V		–	1	3	%
R_{o}	output resistance		–	50	100	Ω
R_{L}	resistive load		1	2	–	k Ω
C_{L}	capacitive load		–	–	25	pF
SVR	supply voltage rejection	note 2	34	–	–	dB

Basic

SAA4977H

SYMBOL	PARAMETER	CONDITIONS	MIN.	TYP.	MAX.	UNIT
α_{ct}	crosstalk attenuation between outputs	0 to 10 MHz	40	–	–	dB
S/N	signal-to-noise ratio	nominal amplitude; 0 to 10 MHz	46	–	–	dB
Output transfer function (sample rate 32 MHz/10 bits)						
INL	integral non linearity		–2	–	+2	LSB
DNL	differential non linearity		–1	–	+1	LSB
Digital output signals: YO, UVO, WE and RSTW ($C_L = 15$ pF); timing referred to SWC clock						
V_{OH}	HIGH-level output voltage	$I_{OH} = -2.0$ mA	2.4	–	–	V
V_{OL}	LOW-level output voltage	$I_{OL} = 1.6$ mA	–	–	0.4	V
$t_{d(o)}$	output delay time	see Fig.10	–	–	20	ns
$t_{h(o)}$	output hold time	see Fig.10	4	–	–	ns
Digital output signal: SWC ($C_L = 15$ pF); timing referred to LLA clock						
V_{OH}	HIGH-level output voltage	$I_{OH} = -2.0$ mA	2.4	–	–	V
V_{OL}	LOW-level output voltage	$I_{OL} = 1.6$ mA	–	–	0.4	V
$t_{d(o)}$	output delay time	see Fig.10	3	–	12	ns
Digital output signal: HRD						
V_{OH}	HIGH-level output voltage	$I_{OH} = -2.0$ mA	2.4	–	–	V
V_{OL}	LOW-level output voltage	$I_{OL} = 1.6$ mA	–	–	0.4	V
Digital output signals: IE2, BLND, RE, HDFL and VDFL ($C_L = 15$ pF); timing referred to LLD clock						
V_{OH}	HIGH-level output voltage	$I_{OH} = -2.0$ mA	2.4	–	–	V
V_{OL}	LOW-level output voltage	$I_{OL} = 1.6$ mA	–	–	0.4	V
$t_{d(o)}$	output delay time	see Fig.10	–	–	20	ns
$t_{h(o)}$	output hold time	see Fig.10	4	–	–	ns
Digital input/output signals: P1.1 to P1.5 and SNRST						
V_{OH}	HIGH-level output voltage	$I_{OH} = -0.06$ mA	2.4	–	–	V
V_{OL}	LOW-level output voltage	$I_{OL} = 1.6$ mA	0	–	0.4	V
V_{IH}	HIGH-level input voltage		2.0	–	5.5	V
V_{IL}	LOW-level input voltage		0	–	0.8	V
Digital input signals: YI and UVI; timing referred to LLD clock						
V_{IH}	HIGH-level input voltage		2.0	–	5.5	V
V_{IL}	LOW-level input voltage		–	–	0.8	V
$t_{su(i)}$	input set-up time	see Fig.10	4	–	–	ns
$t_{h(i)}$	input hold time	see Fig.10	3	–	–	ns

Besic

SAA4977H

SYMBOL	PARAMETER	CONDITIONS	MIN.	TYP.	MAX.	UNIT
Digital input signal: HA; timing referred to LLA clock (only when SELCLK = 0, HA used as digital horizontal reference)						
V _{IH}	HIGH-level input voltage		2.0	–	5.5	V
V _{IL}	LOW-level input voltage		–	–	0.8	V
t _{su(i)}	input set-up time	see Fig.10	7	–	–	ns
t _{h(i)}	input hold time	see Fig.10	4	–	–	ns
Digital input signals: TRST, TMS, RST and VA						
V _{IH}	HIGH-level input voltage		2.0	–	5.5	V
V _{IL}	LOW-level input voltage		–	–	0.8	V
Digital input clock signal: LLA						
f _{LLA}	sample clock frequency		14	16	34	MHz
δ _{clk}	clock duty factor		40	50	60	%
V _{IH}	HIGH-level input voltage		2.4	–	–	V
V _{IL}	LOW-level input voltage		–	–	0.6	V
t _r	clock rise time	see Fig.10	–	–	5	ns
t _f	clock fall time	see Fig.10	–	–	5	ns
Digital input clock signal: LLD						
f _{LLD}	sample clock frequency		30	32	34	MHz
δ _{clk}	clock duty factor		40	50	60	%
V _{IH}	HIGH-level input voltage		2.4	–	–	V
V _{IL}	LOW-level input voltage		–	–	0.6	V
t _r	clock rise time	see Fig.10	–	–	5	ns
t _f	clock fall time	see Fig.10	–	–	5	ns
I²C-bus signal: SDA and SCL; note 3						
V _{IH}	HIGH-level input voltage		0.7V _{DDIO}	–	–	V
V _{IL}	LOW-level input voltage		–	–	0.3V _{DDIO}	V
V _{OL}	LOW-level output voltage	I _{OL} = 3.0 mA	–	–	0.4	V
f _{SCL}	SCL clock frequency		–	–	400	kHz
t _{HD;STA}	hold time START condition		0.6	–	–	μs
t _{LOW}	SCL LOW time		1.3	–	–	μs
t _{HIGH}	SCL HIGH time		0.6	–	–	μs
t _{SU;DAT}	data set-up time		100	–	–	ns
t _{SU;DAT1}	data set-up time (before repeated START condition)		0.6	–	–	μs
t _{SU;DAT2}	data set-up time (before STOP condition)		0.6	–	–	μs
t _{SU;STA}	set-up time repeated START		0.6	–	–	μs
t _{SU;STO}	set-up time STOP condition		0.6	–	–	μs

Basic

SAA4977H

SYMBOL	PARAMETER	CONDITIONS	MIN.	TYP.	MAX.	UNIT
SNERT-bus: SNDA and SNCL; note 4						
V _{OH}	HIGH-level output voltage	I _{OH} = -2.0 mA	2.4	-	-	V
V _{OL}	LOW-level output voltage	I _{OL} = 1.6 mA	-	-	0.4	V
V _{IH}	HIGH-level input voltage		2.0	-	5.5	V
V _{IL}	LOW-level input voltage		-	-	0.8	V
t _{su(i)}	input set-up time		700	-	-	ns
t _{h(i)}	input hold time		0	-	-	ns
t _{cycle}	SNCL cycle time		-	1	-	µs
t _{h(o)}	output hold time		50	-	-	ns

Notes

1. With AGC at -3 dB, U full ADC range is obtained at V_i = 1.89 V; with AGC at +6 dB, U full ADC range is obtained at V_i = 0.67 V; with AGC at -3 dB, V full ADC range is obtained at V_i = 1.48 V; with AGC at +6 dB, V full ADC range is obtained at V_i = 0.52 V.
2. Supply voltage ripple rejection, measured over a frequency range from 20 Hz to 50 kHz. This includes 1/2f_v, f_v, 2f_v, f_H and 2f_H which are major load frequencies: SVR is relative variation of the full scale analog input for a supply variation of 0.25 V.
3. The AC characteristics are in accordance with the I²C-bus specification for fast mode (clock frequency maximum 400 kHz). Information about the I²C-bus can be found in the brochure "I²C-bus and how to use it" (order number 9398 393 40011).
4. More information about the SNERT-bus protocol can be found in Application Note "The SNERT-bus specification" (AN95127).

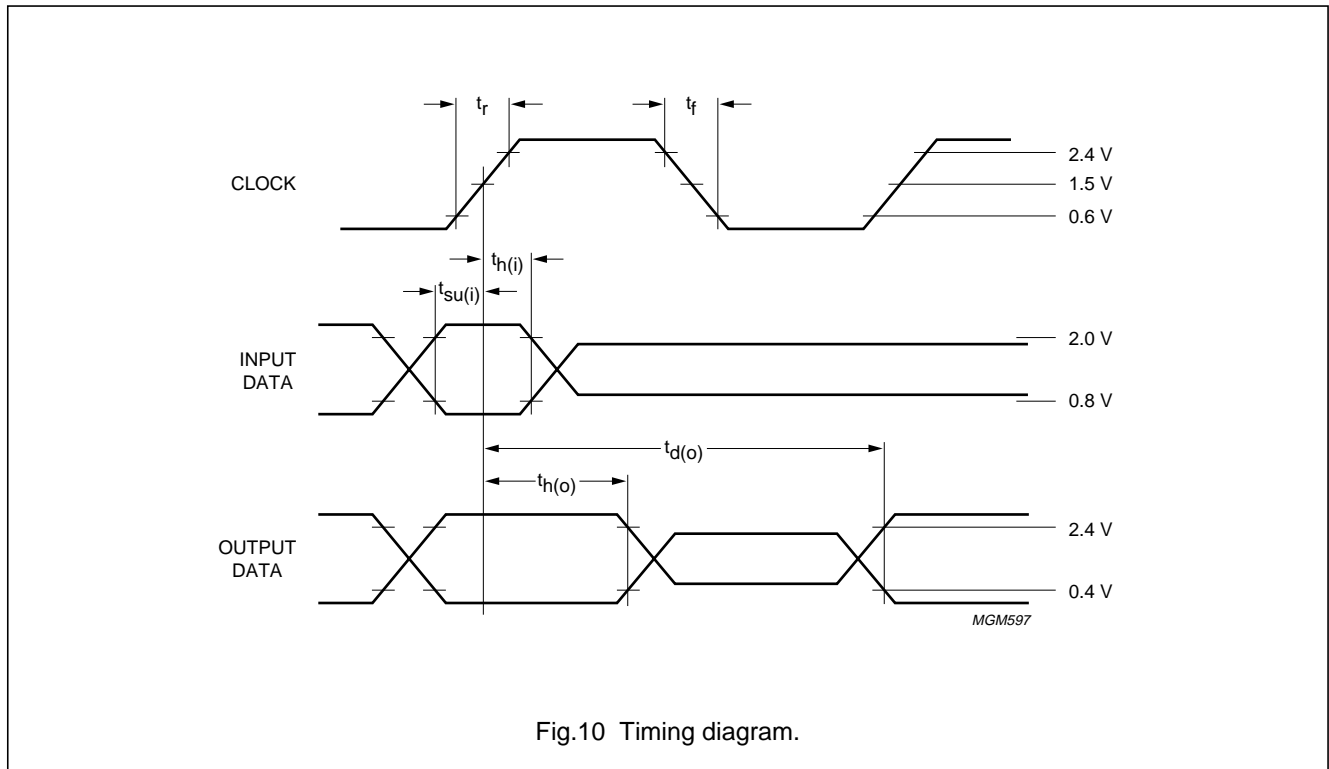

Fig.10 Timing diagram.

Basic

SAA4977H

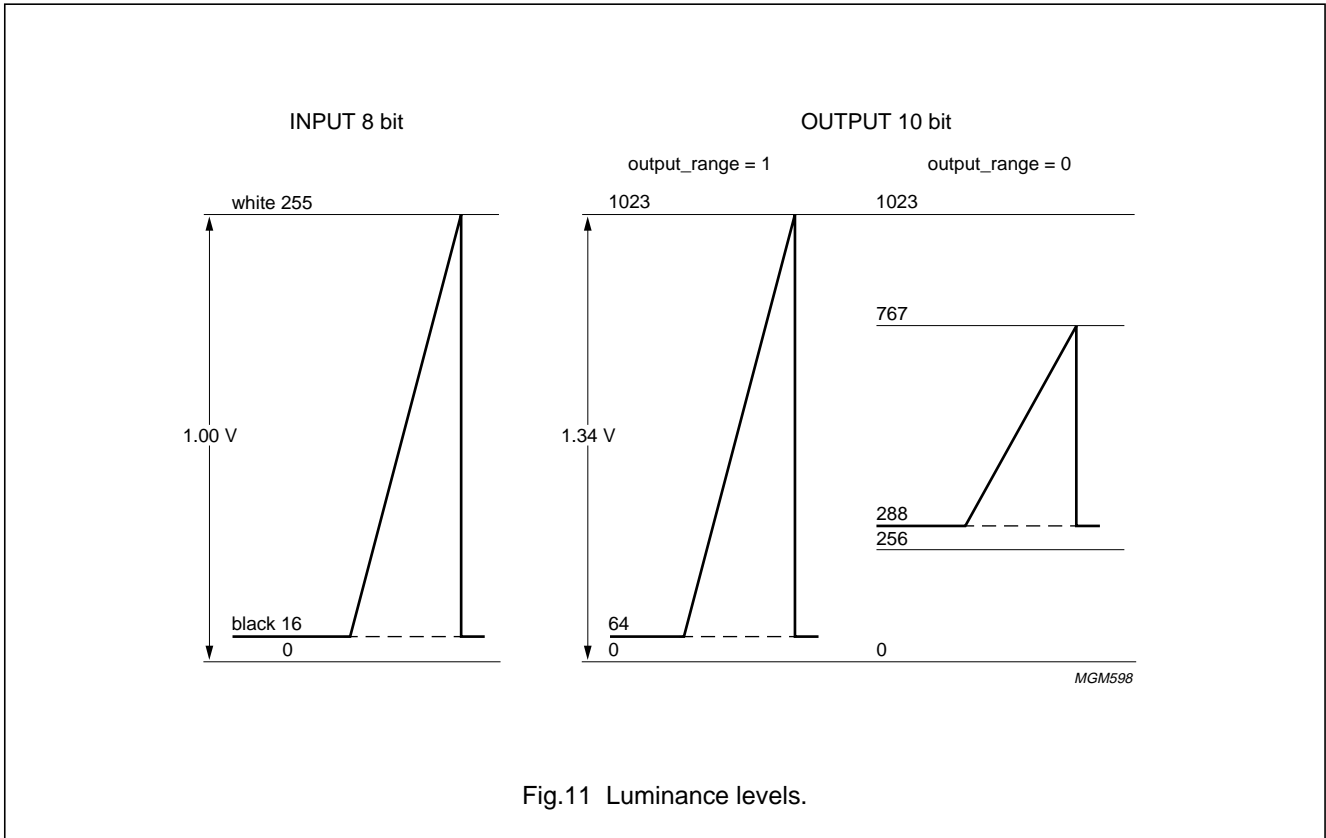

Fig.11 Luminance levels.

11 APPLICATION

The SAA4977H supports two different up-converter concepts. The simple one is shown in Fig.12. In this application only one field memory SAA4955TJ is needed for a 100 Hz conversion based on a field repetition algorithm (AABB mode). The concept can be upgraded by a noise reduction based on a motion adaptive field recursive filter if the SAA4956TJ is used instead of the SAA4955TJ.

The SAA4977H supports a dual-clock system. The acquisition clock is taken from the digital front-end. The display control is based on a clock generated by an external H-PLL. By this structure the stability of the display is enhanced compared to a one-clock system if an unstable source like a VCR is used as an input.

The second system supported by the SAA4977H is shown in Fig.13. This concept needs two field memories (SAA4955TJ) and the signal processing IC MELZONIC (SAA4991WP). The SAA4991WP allows a vector based motion estimation and compensation for a display of 100 Hz pictures in high-end TV sets which is free of motion artefacts. It additionally provides a variable vertical zoom function, noise and cross colour reduction. Furthermore a multi-PIP feature is supported making use of the field memories.

Basic

SAA4977H

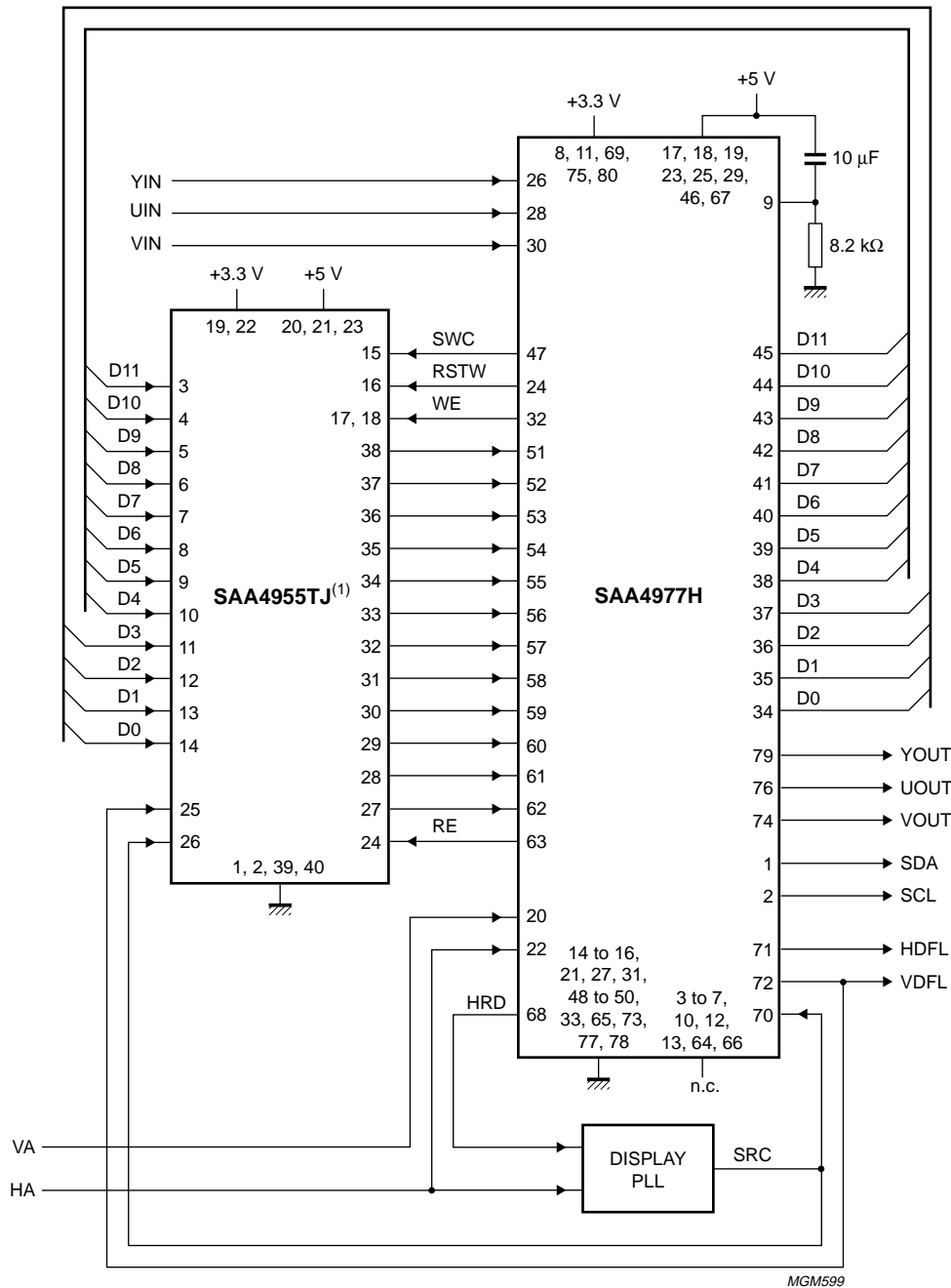

(1) Alternatively SAA4956TJ.

Fig.12 Application diagram 1.

Basic

SAA4977H

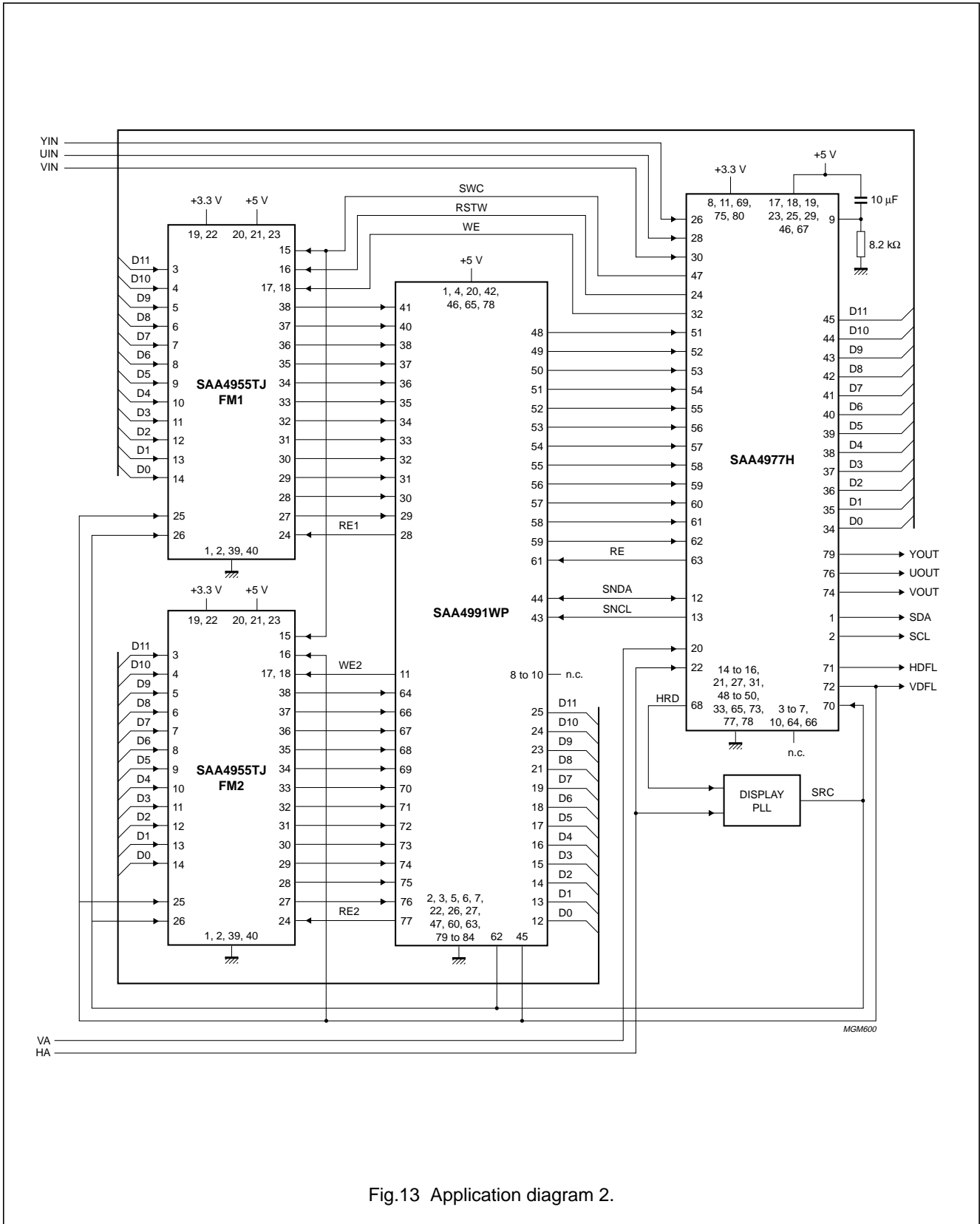

Fig.13 Application diagram 2.

Basic

SAA4977H

12 PACKAGE OUTLINE

QFP80: plastic quad flat package; 80 leads (lead length 1.95 mm); body 14 x 20 x 2.8 mm

SOT318-2

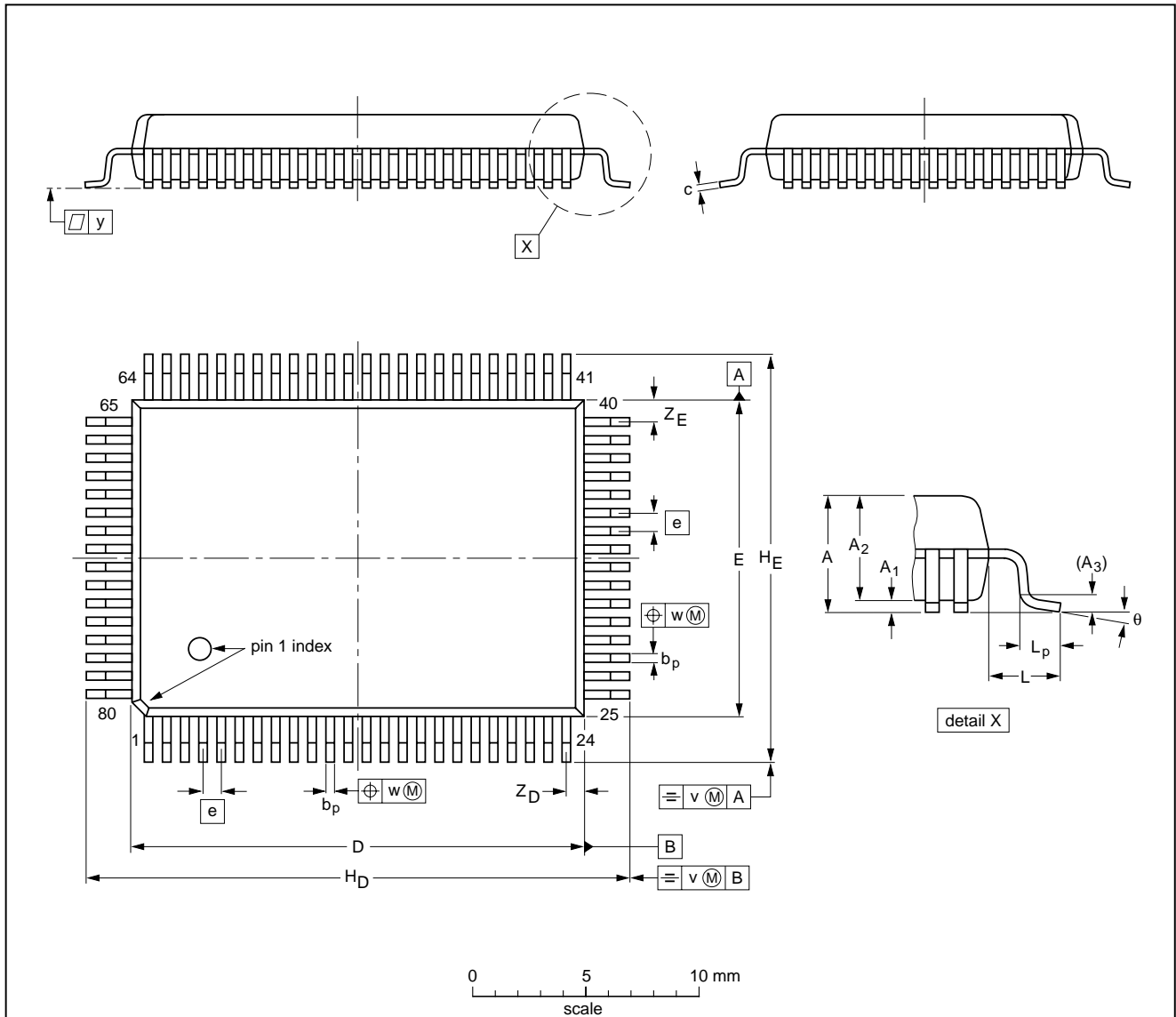

DIMENSIONS (mm are the original dimensions)

UNIT	A max.	A ₁	A ₂	A ₃	b _p	c	D ⁽¹⁾	E ⁽¹⁾	e	H _D	H _E	L	L _p	v	w	y	Z _D ⁽¹⁾	Z _E ⁽¹⁾	θ
mm	3.2	0.25 0.05	2.90 2.65	0.25	0.45 0.30	0.25 0.14	20.1 19.9	14.1 13.9	0.8	24.2 23.6	18.2 17.6	1.95	1.0 0.6	0.2	0.2	0.1	1.0 0.6	1.2 0.8	7° 0°

Note

1. Plastic or metal protrusions of 0.25 mm maximum per side are not included.

OUTLINE VERSION	REFERENCES			EUROPEAN PROJECTION	ISSUE DATE
	IEC	JEDEC	EIAJ		
SOT318-2					95-02-04 97-08-01

Besic

SAA4977H

13 SOLDERING**13.1 Introduction**

There is no soldering method that is ideal for all IC packages. Wave soldering is often preferred when through-hole and surface mounted components are mixed on one printed-circuit board. However, wave soldering is not always suitable for surface mounted ICs, or for printed-circuits with high population densities. In these situations reflow soldering is often used.

This text gives a very brief insight to a complex technology. A more in-depth account of soldering ICs can be found in our *"Data Handbook IC26; Integrated Circuit Packages"* (order code 9398 652 90011).

13.2 Reflow soldering

Reflow soldering techniques are suitable for all QFP packages.

The choice of heating method may be influenced by larger plastic QFP packages (44 leads, or more). If infrared or vapour phase heating is used and the large packages are not absolutely dry (less than 0.1% moisture content by weight), vaporization of the small amount of moisture in them can cause cracking of the plastic body. For details, refer to the Drypack information in the *"Data Handbook IC26; Integrated Circuit Packages; Section: Packing Methods"*.

Reflow soldering requires solder paste (a suspension of fine solder particles, flux and binding agent) to be applied to the printed-circuit board by screen printing, stencilling or pressure-syringe dispensing before package placement.

Several methods exist for reflowing; for example, infrared/convection heating in a conveyor type oven. Throughput times (preheating, soldering and cooling) vary between 50 and 300 seconds depending on heating method. Typical reflow peak temperatures range from 215 to 250 °C.

13.3 Wave soldering

Wave soldering is **not** recommended for QFP packages. This is because of the likelihood of solder bridging due to closely-spaced leads and the possibility of incomplete solder penetration in multi-lead devices.

If wave soldering cannot be avoided, for QFP packages with a pitch (e) larger than 0.5 mm, the following conditions must be observed:

- **A double-wave (a turbulent wave with high upward pressure followed by a smooth laminar wave) soldering technique should be used.**
- **The footprint must be at an angle of 45° to the board direction and must incorporate solder thieves downstream and at the side corners.**

During placement and before soldering, the package must be fixed with a droplet of adhesive. The adhesive can be applied by screen printing, pin transfer or syringe dispensing. The package can be soldered after the adhesive is cured.

Maximum permissible solder temperature is 260 °C, and maximum duration of package immersion in solder is 10 seconds, if cooled to less than 150 °C within 6 seconds. Typical dwell time is 4 seconds at 250 °C.

A mildly-activated flux will eliminate the need for removal of corrosive residues in most applications.

13.4 Repairing soldered joints

Fix the component by first soldering two diagonally-opposite end leads. Use only a low voltage soldering iron (less than 24 V) applied to the flat part of the lead. Contact time must be limited to 10 seconds at up to 300 °C. When using a dedicated tool, all other leads can be soldered in one operation within 2 to 5 seconds between 270 and 320 °C.

CAUTION

Wave soldering is NOT applicable for all QFP packages with a pitch (e) equal or less than 0.5 mm.

Basic

SAA4977H

14 DEFINITIONS

Data sheet status	
Objective specification	This data sheet contains target or goal specifications for product development.
Preliminary specification	This data sheet contains preliminary data; supplementary data may be published later.
Product specification	This data sheet contains final product specifications.
Limiting values	
Limiting values given are in accordance with the Absolute Maximum Rating System (IEC 134). Stress above one or more of the limiting values may cause permanent damage to the device. These are stress ratings only and operation of the device at these or at any other conditions above those given in the Characteristics sections of the specification is not implied. Exposure to limiting values for extended periods may affect device reliability.	
Application information	
Where application information is given, it is advisory and does not form part of the specification.	

15 LIFE SUPPORT APPLICATIONS

These products are not designed for use in life support appliances, devices, or systems where malfunction of these products can reasonably be expected to result in personal injury. Philips customers using or selling these products for use in such applications do so at their own risk and agree to fully indemnify Philips for any damages resulting from such improper use or sale.

16 PURCHASE OF PHILIPS I²C COMPONENTS

Purchase of Philips I²C components conveys a license under the Philips' I²C patent to use the components in the I²C system provided the system conforms to the I²C specification defined by Philips. This specification can be ordered using the code 9398 393 40011.

Basic

SAA4977H

NOTES

Philips Semiconductors – a worldwide company

Argentina: see South America

Australia: 34 Waterloo Road, NORTH RYDE, NSW 2113,
Tel. +61 2 9805 4455, Fax. +61 2 9805 4466

Austria: Computerstr. 6, A-1101 WIEN, P.O. Box 213, Tel. +43 160 1010,
Fax. +43 160 101 1210

Belarus: Hotel Minsk Business Center, Bld. 3, r. 1211, Volodarski Str. 6,
220050 MINSK, Tel. +375 172 200 733, Fax. +375 172 200 773

Belgium: see The Netherlands

Brazil: see South America

Bulgaria: Philips Bulgaria Ltd., Energoproject, 15th floor,
51 James Bourchier Blvd., 1407 SOFIA,
Tel. +359 2 689 211, Fax. +359 2 689 102

Canada: PHILIPS SEMICONDUCTORS/COMPONENTS,
Tel. +1 800 234 7381

China/Hong Kong: 501 Hong Kong Industrial Technology Centre,
72 Tat Chee Avenue, Kowloon Tong, HONG KONG,
Tel. +852 2319 7888, Fax. +852 2319 7700

Colombia: see South America

Czech Republic: see Austria

Denmark: Prags Boulevard 80, PB 1919, DK-2300 COPENHAGEN S,
Tel. +45 32 88 2636, Fax. +45 31 57 0044

Finland: Sinikalliontie 3, FIN-02630 ESPOO,
Tel. +358 9 615800, Fax. +358 9 61580920

France: 51 Rue Carnot, BP317, 92156 SURESNES Cedex,
Tel. +33 1 40 99 6161, Fax. +33 1 40 99 6427

Germany: Hammerbrookstraße 69, D-20097 HAMBURG,
Tel. +49 40 23 53 60, Fax. +49 40 23 536 300

Greece: No. 15, 25th March Street, GR 17778 TAVROS/ATHENS,
Tel. +30 1 4894 339/239, Fax. +30 1 4814 240

Hungary: see Austria

India: Philips INDIA Ltd, Band Box Building, 2nd floor,
254-D, Dr. Annie Besant Road, Worli, MUMBAI 400 025,
Tel. +91 22 493 8541, Fax. +91 22 493 0966

Indonesia: PT Philips Development Corporation, Semiconductors Division,
Gedung Philips, Jl. Buncit Raya Kav.99-100, JAKARTA 12510,
Tel. +62 21 794 0040 ext. 2501, Fax. +62 21 794 0080

Ireland: Newstead, Clonskeagh, DUBLIN 14,
Tel. +353 1 7640 000, Fax. +353 1 7640 200

Israel: RAPAC Electronics, 7 Kehilat Saloniki St, PO Box 18053,
TEL AVIV 61180, Tel. +972 3 645 0444, Fax. +972 3 649 1007

Italy: PHILIPS SEMICONDUCTORS, Piazza IV Novembre 3,
20124 MILANO, Tel. +39 2 6752 2531, Fax. +39 2 6752 2557

Japan: Philips Bldg 13-37, Kohnan 2-chome, Minato-ku,
TOKYO 108-8507, Tel. +81 3 3740 5130, Fax. +81 3 3740 5077

Korea: Philips House, 260-199 Itaewon-dong, Yongsan-ku, SEOUL,
Tel. +82 2 709 1412, Fax. +82 2 709 1415

Malaysia: No. 76 Jalan Universiti, 46200 PETALING JAYA, SELANGOR,
Tel. +60 3 750 5214, Fax. +60 3 757 4880

Mexico: 5900 Gateway East, Suite 200, EL PASO, TEXAS 79905,
Tel. +9-5 800 234 7381

Middle East: see Italy

Netherlands: Postbus 90050, 5600 PB EINDHOVEN, Bldg. VB,
Tel. +31 40 27 82785, Fax. +31 40 27 88399

New Zealand: 2 Wagener Place, C.P.O. Box 1041, AUCKLAND,
Tel. +64 9 849 4160, Fax. +64 9 849 7811

Norway: Box 1, Manglerud 0612, OSLO,
Tel. +47 22 74 8000, Fax. +47 22 74 8341

Pakistan: see Singapore

Philippines: Philips Semiconductors Philippines Inc.,
106 Valero St. Salcedo Village, P.O. Box 2108 MCC, MAKATI,
Metro MANILA, Tel. +63 2 816 6380, Fax. +63 2 817 3474

Poland: Ul. Lukiska 10, PL 04-123 WARSZAWA,
Tel. +48 22 612 2831, Fax. +48 22 612 2327

Portugal: see Spain

Romania: see Italy

Russia: Philips Russia, Ul. Usatcheva 35A, 119048 MOSCOW,
Tel. +7 095 755 6918, Fax. +7 095 755 6919

Singapore: Lorong 1, Toa Payoh, SINGAPORE 319762,
Tel. +65 350 2538, Fax. +65 251 6500

Slovakia: see Austria

Slovenia: see Italy

South Africa: S.A. PHILIPS Pty Ltd., 195-215 Main Road Martindale,
2092 JOHANNESBURG, P.O. Box 7430 Johannesburg 2000,
Tel. +27 11 470 5911, Fax. +27 11 470 5494

South America: Al. Vicente Pinzon, 173, 6th floor,
04547-130 SÃO PAULO, SP, Brazil,
Tel. +55 11 821 2333, Fax. +55 11 821 2382

Spain: Balmes 22, 08007 BARCELONA,
Tel. +34 93 301 6312, Fax. +34 93 301 4107

Sweden: Kottbygatan 7, Akalla, S-16485 STOCKHOLM,
Tel. +46 8 5985 2000, Fax. +46 8 5985 2745

Switzerland: Allmendstrasse 140, CH-8027 ZÜRICH,
Tel. +41 1 488 2741 Fax. +41 1 488 3263

Taiwan: Philips Semiconductors, 6F, No. 96, Chien Kuo N. Rd., Sec. 1,
TAIPEI, Taiwan Tel. +886 2 2134 2865, Fax. +886 2 2134 2874

Thailand: PHILIPS ELECTRONICS (THAILAND) Ltd.,
209/2 Sanpavuth-Bangna Road Prakanong, BANGKOK 10260,
Tel. +66 2 745 4090, Fax. +66 2 398 0793

Turkey: Talatpasa Cad. No. 5, 80640 GÜLTEPE/ISTANBUL,
Tel. +90 212 279 2770, Fax. +90 212 282 6707

Ukraine: PHILIPS UKRAINE, 4 Patrice Lumumba str., Building B, Floor 7,
252042 KIEV, Tel. +380 44 264 2776, Fax. +380 44 268 0461

United Kingdom: Philips Semiconductors Ltd., 276 Bath Road, Hayes,
MIDDLESEX UB3 5BX, Tel. +44 181 730 5000, Fax. +44 181 754 8421

United States: 811 East Arques Avenue, SUNNYVALE, CA 94088-3409,
Tel. +1 800 234 7381

Uruguay: see South America

Vietnam: see Singapore

Yugoslavia: PHILIPS, Trg N. Pasica 5/v, 11000 BEOGRAD,
Tel. +381 11 625 344, Fax. +381 11 635 777

For all other countries apply to: Philips Semiconductors,
International Marketing & Sales Communications, Building BE-p, P.O. Box 218,
5600 MD EINDHOVEN, The Netherlands, Fax. +31 40 27 24825

Internet: <http://www.semiconductors.philips.com>

© Philips Electronics N.V. 1998

SCA60

All rights are reserved. Reproduction in whole or in part is prohibited without the prior written consent of the copyright owner.

The information presented in this document does not form part of any quotation or contract, is believed to be accurate and reliable and may be changed without notice. No liability will be accepted by the publisher for any consequence of its use. Publication thereof does not convey nor imply any license under patent- or other industrial or intellectual property rights.

Printed in The Netherlands

545104/00/01/pp32

Date of release: 1998 Jul 23

Document order number: 9397 750 03258

Let's make things better.