



# SD2931-10

## RF POWER TRANSISTORS HF/VHF/UHF N-CHANNEL MOSFETs

### ADVANCE DATA

- ✓ GOLD METALLIZATION
- ✓ EXCELLENT THERMAL STABILITY
- ✓ COMMON SOURCE CONFIGURATION
- ✓ POUT = 150W MIN. WITH 14 dB gain @175 MHz
- ✓ THERMALLY ENHANCED PACKAGING FOR LOWER JUNCTION TEMPERATURES

### DESCRIPTION

The SD2931-10 is a gold metallized N-Channel MOS field-effect RF power transistor. Being electrically identical to the standard SD2931 MOSFET, it is intended for use in 50V dc large signal applications up to 230 MHz.

The SD2931-10 is mechanical compatible to the SD2931 but offers in addition a better thermal capability (25 % lower thermal resistance), representing the best-in-class transistors for ISM applications.

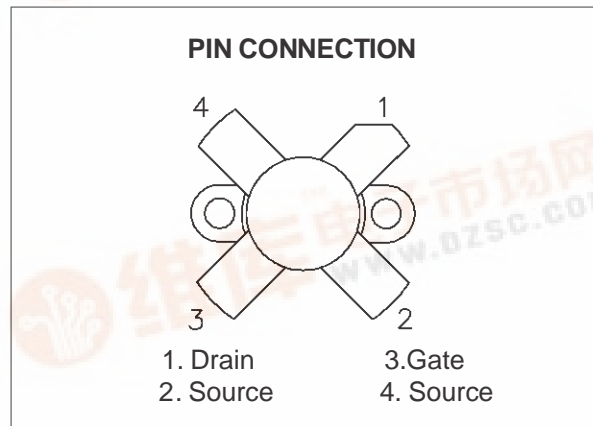
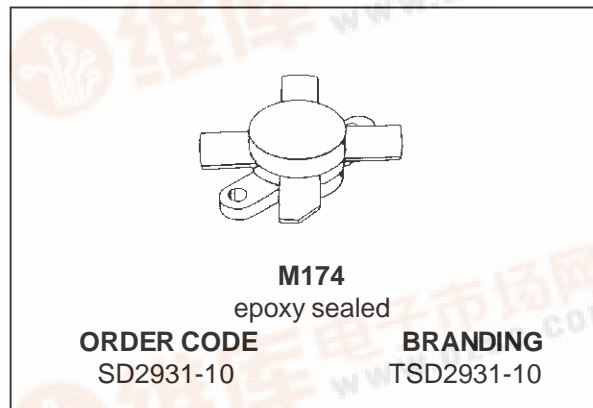

### ABSOLUTE MAXIMUM RATINGS (T<sub>case</sub> = 25 °C)

Symbol	Parameter	Value	Unit
V <sub>(BR)DSS</sub>	Drain Source Voltage	125	V
V <sub>DGR</sub>	Drain-Gate Voltage (R <sub>GS</sub> = 1MΩ)	125	V
V <sub>GS</sub>	Gate-Source Voltage	±20	V
I <sub>D</sub>	Drain Current	20	A
P <sub>DISS</sub>	Power Dissipation	389	W
T <sub>j</sub>	Max. Operating Junction Temperature	200	°C
T <sub>STG</sub>	Storage Temperature	-65 to 150	°C

### THERMAL DATA

R <sub>th(j-c)</sub>	Junction-Case Thermal Resistance	0.45	°C/W
R <sub>th(c-s)</sub>	Case-Heatsink Thermal Resistance *	0.2	°C/W

\* Determined using a flat aluminum or copper heatsink with thermal compound applied (Dow Corning 340 or equivalent).



# SD2931-10

## ELECTRICAL SPECIFICATION (T<sub>case</sub> = 25 °C)

### STATIC

Symbol	Parameter	Min.	Typ.	Max.	Unit
V <sub>(BR)DSS</sub>	V <sub>GS</sub> = 0V I <sub>DS</sub> = 100 mA	125			V
I <sub>DSS</sub>	V <sub>GS</sub> = 0V V <sub>DS</sub> = 50 V			5	mA
I <sub>GSS</sub>	V <sub>GS</sub> = 20V V <sub>DS</sub> = 0 V			5	μA
V <sub>GS(Q)</sub> *	V <sub>DS</sub> = 10V I <sub>D</sub> = 250 mA	2.0		5.0	V
V <sub>DS(ON)</sub>	V <sub>GS</sub> = 10V I <sub>D</sub> = 10 A			3.0	V
G <sub>FS</sub>	V <sub>DS</sub> = 10V I <sub>D</sub> = 5 A	5			mho
C <sub>ISS</sub>	V <sub>GS</sub> = 0V V <sub>DS</sub> = 50 V f = 1 MHz		480		pF
C <sub>OSS</sub>	V <sub>GS</sub> = 0V V <sub>DS</sub> = 50 V f = 1 MHz		190		pF
C <sub>RSS</sub>	V <sub>GS</sub> = 0V V <sub>DS</sub> = 50 V f = 1 MHz		18		pF

\* V<sub>GS(Q)</sub> sorted with alpha/numeric code marked on unit.

REF. 7165489C

### DYNAMIC

Symbol	Parameter	Min.	Typ.	Max.	Unit
P <sub>OUT</sub>	f = 175 MHz V <sub>DD</sub> = 50 V I <sub>DQ</sub> = 250 mA	150			W
G <sub>PS</sub>	f = 175 MHz V <sub>DD</sub> = 50 V P <sub>out</sub> = 150 W I <sub>DQ</sub> = 250 mA	14	15		dB
η <sub>D</sub>	f = 175 MHz V <sub>DD</sub> = 50 V P <sub>out</sub> = 150 W I <sub>DQ</sub> = 250 mA	55	65		%
Load Mismatch	f = 175 MHz V <sub>DD</sub> = 50 V P <sub>out</sub> = 150 W I <sub>DQ</sub> = 250 mA All Phase Angles	10:1			VSWR

### IMPEDANCE DATA

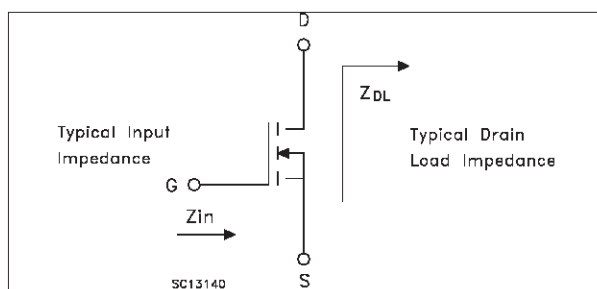

FREQ.	Z <sub>IN</sub> (Ω)	Z <sub>DL</sub> (Ω)
30 MHz	1.7 - j 5.7	6.8 + j 0.9
175 MHz	1.2 - j 2.0	2.0 + j 2.4

### V<sub>GS</sub> SORTS

A	2.0 - 2.1	R	3.5 - 3.6
B	2.1 - 2.2	S	3.6 - 3.7
C	2.2 - 2.3	T	3.7 - 3.8
D	2.3 - 2.4	U	3.8 - 3.9
E	2.4 - 2.5	V	3.9 - 4.0
F	2.5 - 2.6	W	4.0 - 4.1
G	2.6 - 2.7	X	4.1 - 4.2
H	2.7 - 2.8	Y	4.2 - 4.3
J	2.8 - 2.9	Z	4.3 - 4.4
K	2.9 - 3.0	2	4.4 - 4.5
L	3.0 - 3.1	3	4.5 - 4.6
M	3.1 - 3.2	4	4.6 - 4.7
N	3.2 - 3.3	5	4.7 - 4.8
P	3.3 - 3.4	6	4.8 - 4.9
Q	3.4 - 3.5	7	4.9 - 5.0

TYPICAL PERFORMANCE

Capacitance vs Drain-Source Voltage

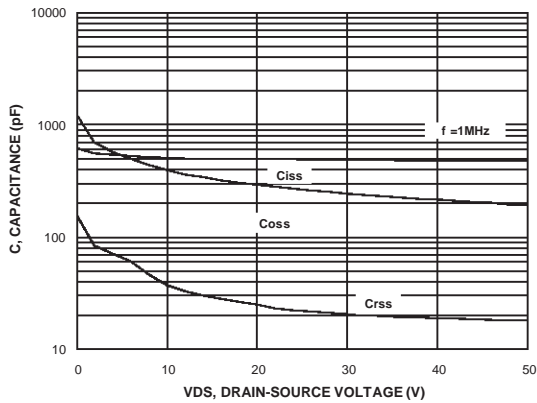

Drain Current vs Gate Voltage

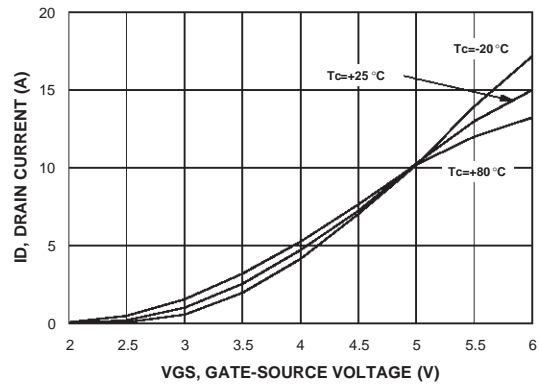

Gate-Source Voltages vs Case Temperature

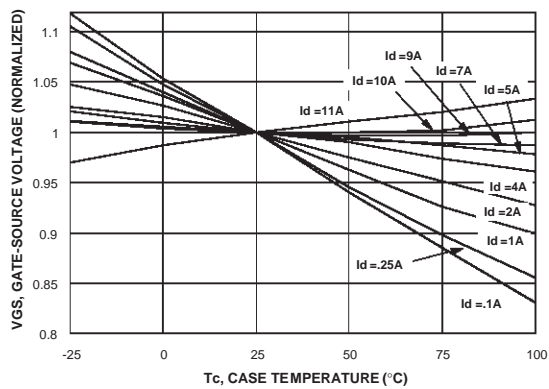

Maximum Thermal Resistance vs Case Temperature

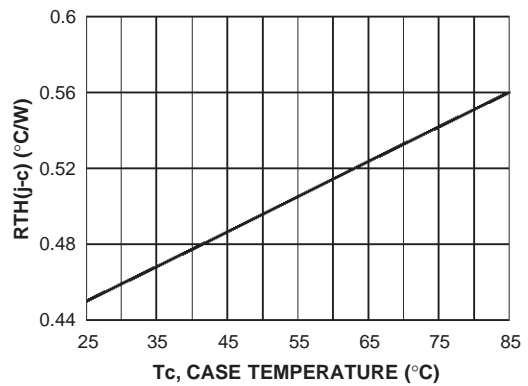

DC Safe Operating Area

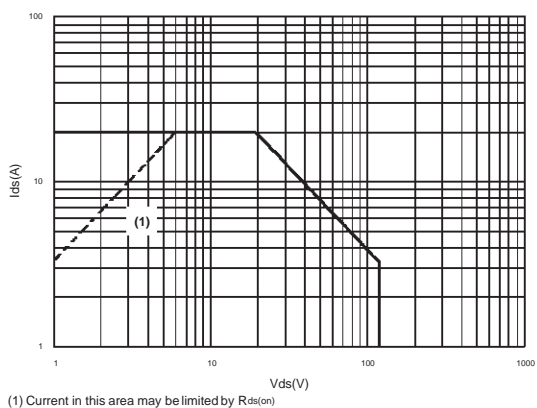

(1) Current in this area may be limited by  $R_{ds(on)}$

TYPICAL PERFORMANCE (175 MHz)

Output Power vs Input Power

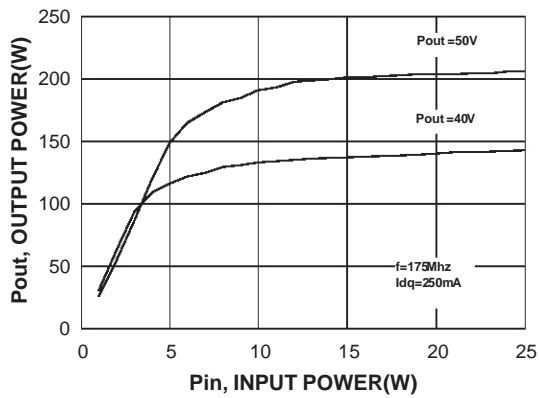

Output Power vs Input Power

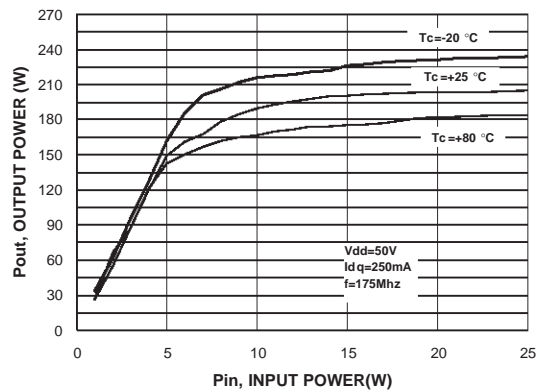

Power Gain vs Output Power

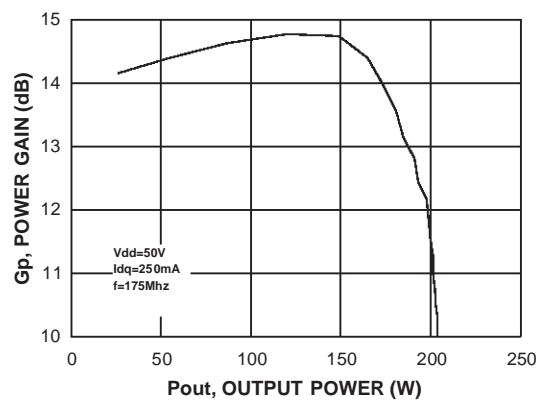

Efficiency vs Output Power

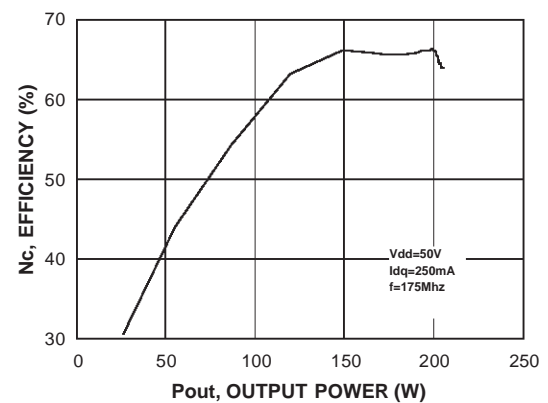

Output Power vs Supply Voltage

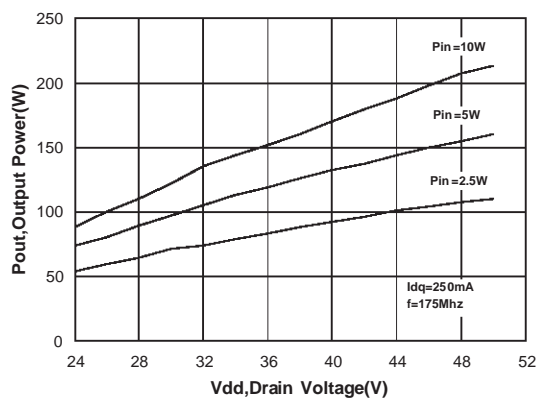

Output Power vs Gate Voltage

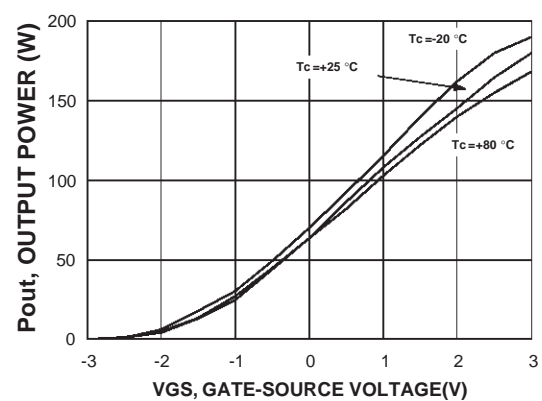

## 175 MHz Test Circuit Schematic (Production Test Circuit)

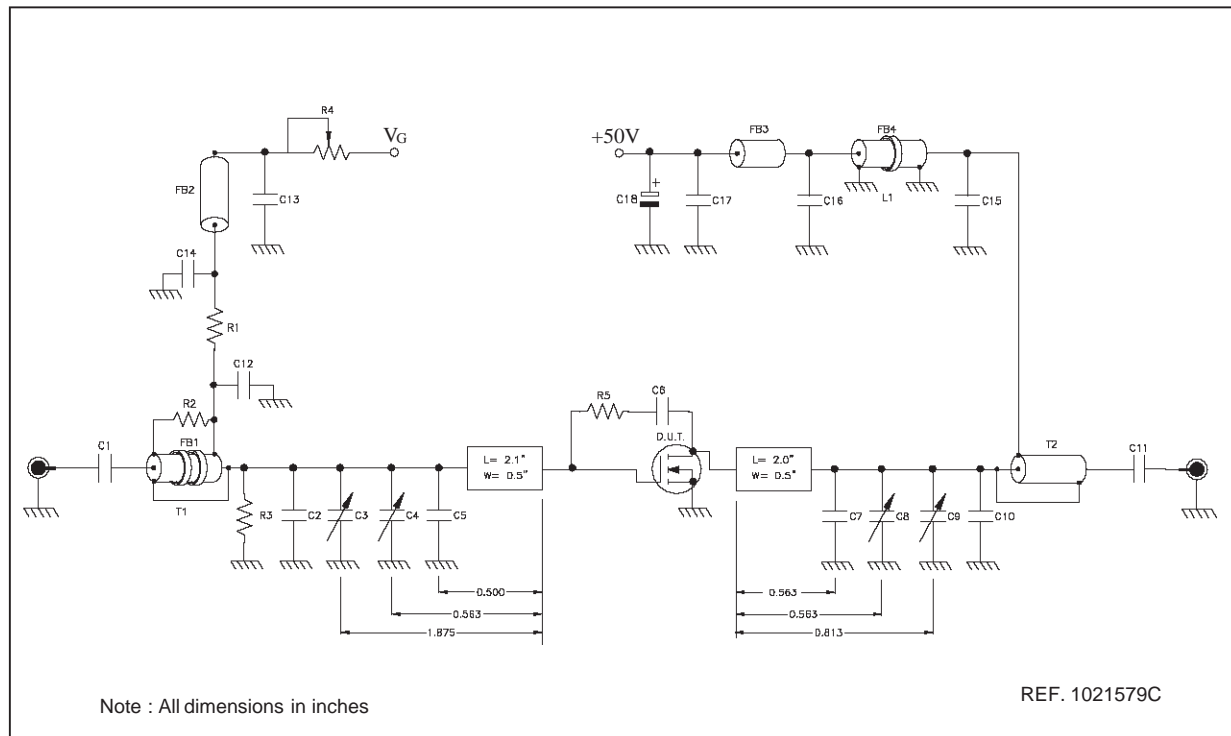

## 175 MHz Test Circuit Component Part List

T1	4:1 Transformer, 25 ohm Flexible Coax .090 OD 6 " Long	
T2	1:4 Transformer, 25 ohm Semi-Rigid Coax .141 OD 6 " Long	
FB1	Toroid X2, 0.5" OD .312" ID 850u 2 Turns	
FB2, FB3	VK200	
FB4	Shield Bead, 1" OD 0.5" ID 850u 3 Turns	
L1	1/4Wave Choke, 50 ohm Semi-Rigid Coax .141 OD 12 " Long	
PCB	0.062" Woven Fiberglass, 1 oz. Copper, 2 Sides, er = 2.55	
R1, R3	470 ohm 1W Chip Resistor	R4 20K ohm 10 Turn Potentiometer
R2	360 ohm 1/2W Resistor	R5 560 ohm 1W Resistor
C1, C11	470 pF ATC Chip Cap	C7 30 pF ATC Chip Cap
C2	43 pF ATC Chip Cap	C10 91 pF ATC Chip Cap
C3, C8, C9	Arco 404, 12-65 pF	C12, C15 1200 pF ATC Chip Cap
C4	Arco 423, 16-100 pF	C13, C14 0.01 uF / 500V Chip Cap
C5	120 pF ATC Chip Cap	C16, C17 0.01 uF / 500V Chip Cap
C6	0.01 uF ATC Chip Cap	C18 10 uF 63V Electrolytic Capacitor

# SD2931-10

## 175 MHz Test Circuit Photomaster

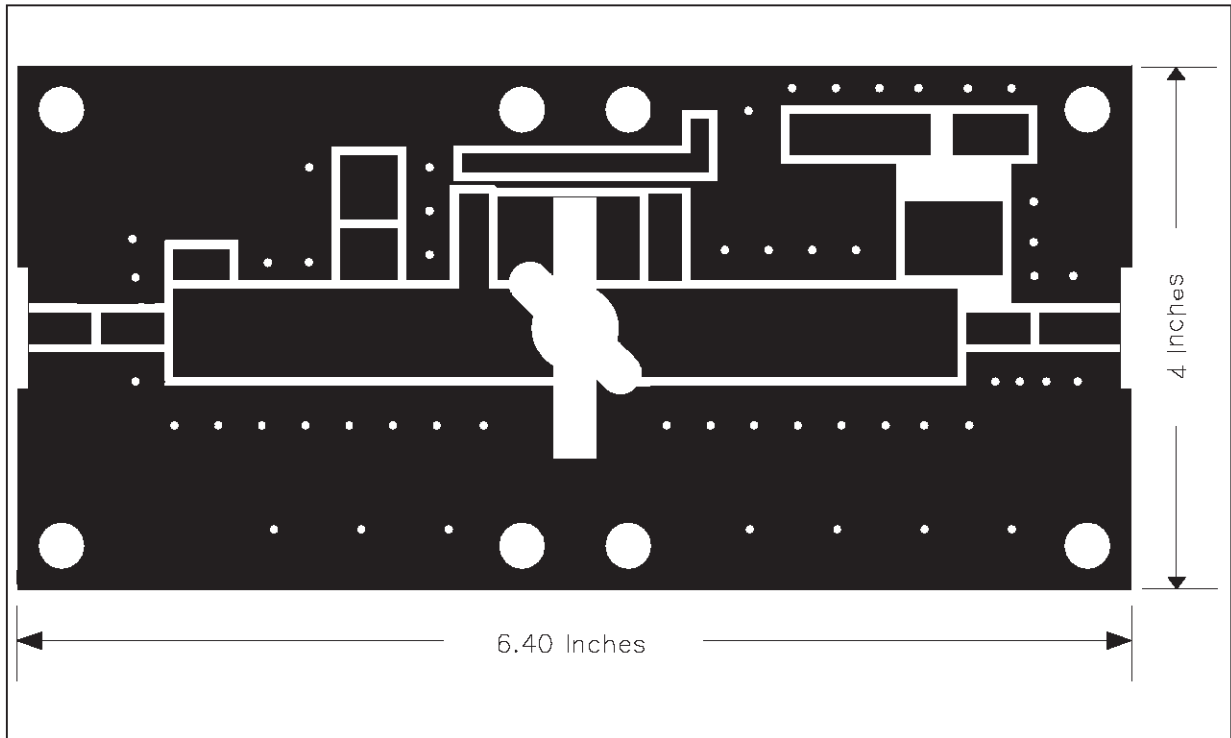

## 175 MHz Test Circuit

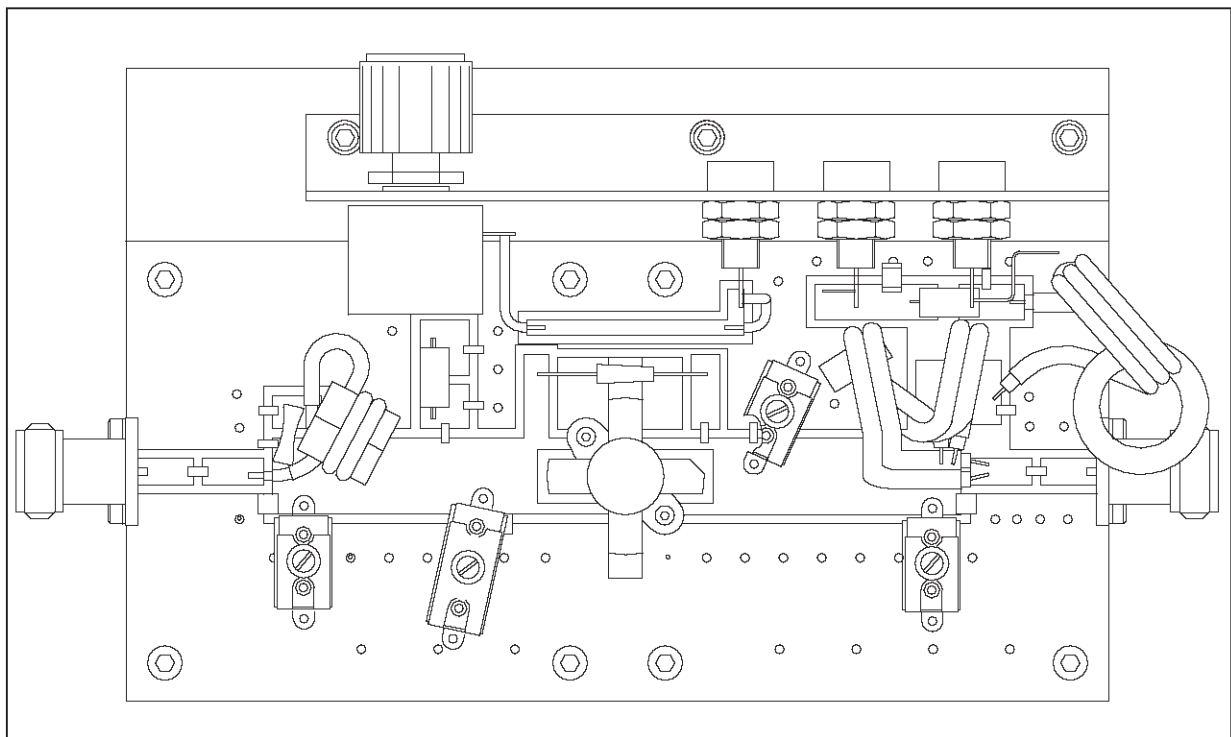

## TYPICAL PERFORMANCE (30 MHz)

Output Power vs Input Power

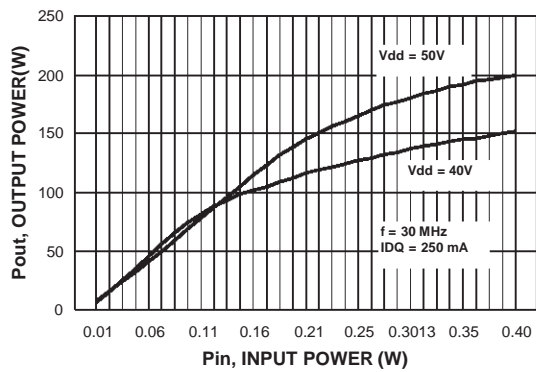

Power Gain vs Output Power

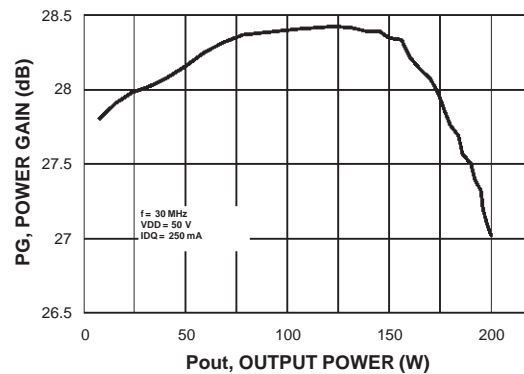

Efficiency vs Output Power

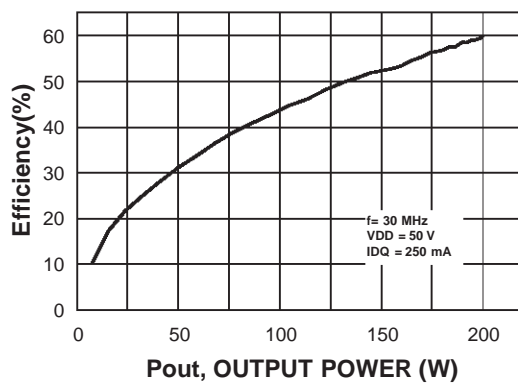

Output Power vs Supply Voltage

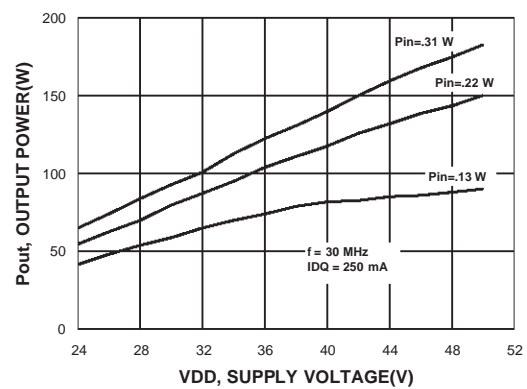

Output Power vs Gate Voltage

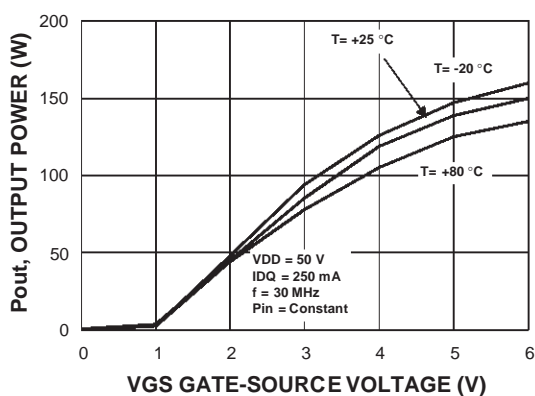

## SD2931-10

### 30 MHz Test Circuit Schematic (Engineering Test Circuit)

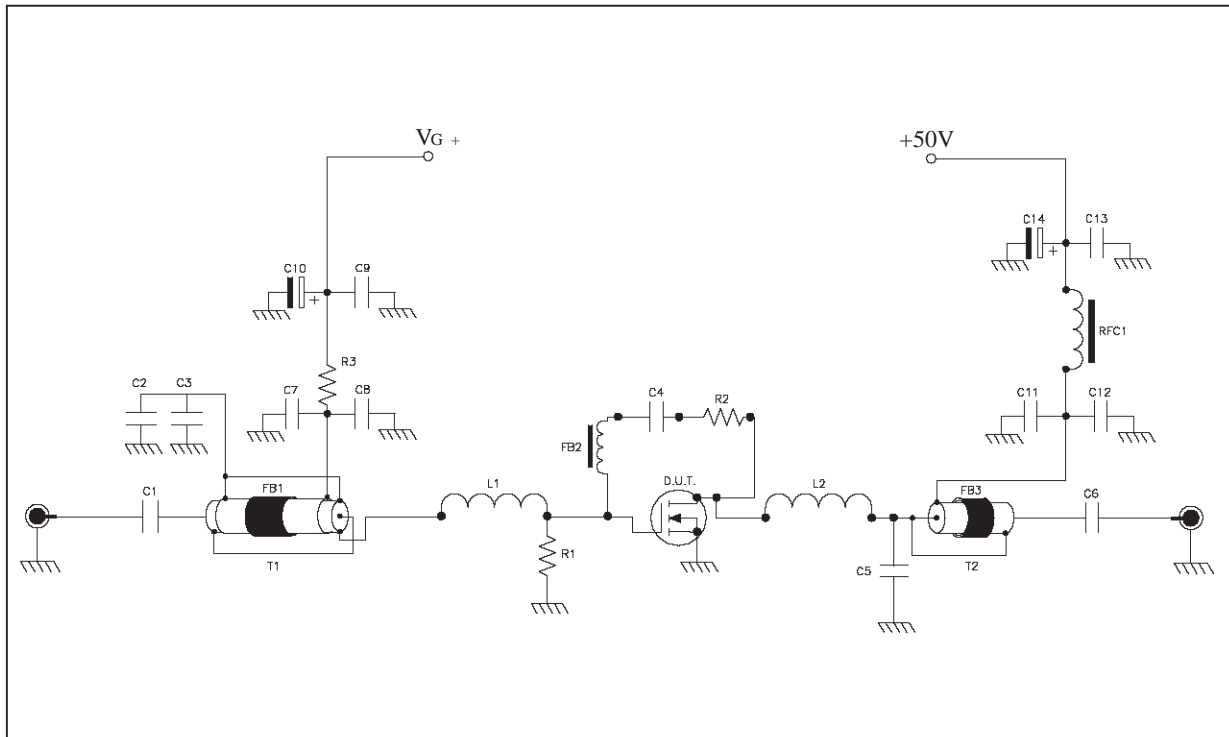

### 30 MHz Test Circuit Component Part List

T1	9:1 Transformer, 25 ohm Flexible Coax with extra shield .090 OD 15" Long	
T2	1:4 Transformer, 50 ohm Flexible Coax .225 OD 15" Long	
FB1	Toroid, 1.7" OD .30" ID 220u 4 Turns	
FB2	Surface Mount EMI Shield Bead	
FB3	Toroid, 1.7" OD .300" ID 220u 3 Turns	
RFC1	Toroid, 0.5" OD 0.30" ID, 125u 4 turns 12 awg wire	
PCB	0.062" Woven Fiberglass, 1 oz. Copper, 2 Sides, er = 2.55	
C1, C4, C6, C7, C8,	C5	470 pF ATC Chip Cap
C9, C11, C12, C13	C10	10 uF 63V Electrolytic Capacitor
C2, C3	C14	100 uF 63V Electrolytic Capacitor
R1, R3	R2	680 ohm 3W Wirewound Resistor



**M174 (.500 DIA 4L N/HERM W/FLG) MECHANICAL DATA**

DIM.	mm			inch		
	MIN.	TYP.	MAX.	MIN.	TYP.	MAX.
A	5.56		5.84	0.219		0.230
B		3.18			0.125	
C	6.22		6.48	0.245		0.255
D	18.28		18.54	0.720		0.730
E		3.18			0.125	
F	24.64		24.89	0.970		0.980
G	12.57		12.83	0.495		0.505
H	0.08		0.18	0.003		0.007
I	2.11		3.00	0.083		0.118
J	3.81		4.45	0.150		0.175
K			7.11			0.280
L	25.53		26.67	1.005		1.050
M	3.05		3.30	0.120		0.130

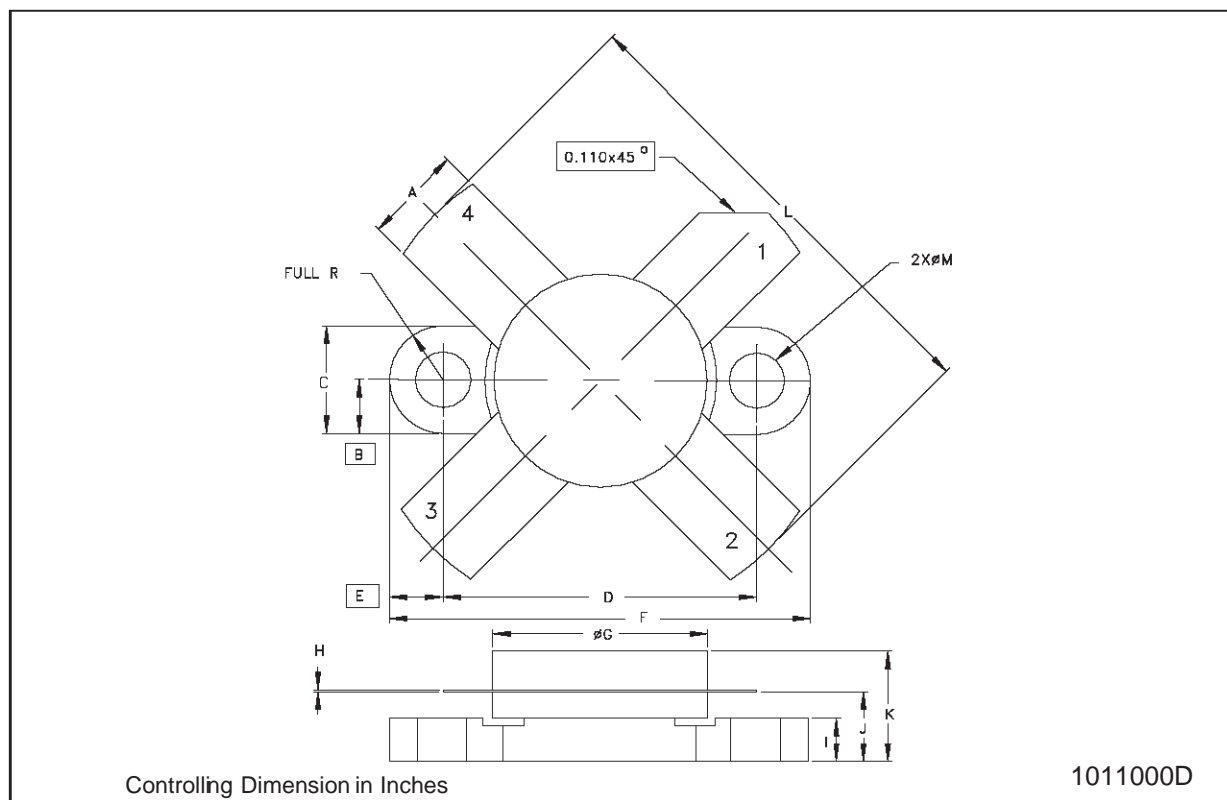

Information furnished is believed to be accurate and reliable. However, STMicroelectronics assumes no responsibility for the consequences of use of such information nor for any infringement of patents or other rights of third parties which may result from its use. No license is granted by implication or otherwise under any patent or patent rights of STMicroelectronics. Specification mentioned in this publication are subject to change without notice. This publication supersedes and replaces all information previously supplied. STMicroelectronics products are not authorized for use as critical components in life support devices or systems without express written approval of STMicroelectronics.

The ST logo is a trademark of STMicroelectronics

© 2000 STMicroelectronics – Printed in Italy – All Rights Reserved

STMicroelectronics GROUP OF COMPANIES

Australia - Brazil - China - Finland - France - Germany - Hong Kong - India - Italy - Japan - Malaysia - Malta - Morocco - Singapore - Spain - Sweden - Switzerland - United Kingdom - U.S.A.

<http://www.st.com>