



SD57045-01

RF POWER TRANSISTORS The *Ldmo*ST FAMILY

ADVANCE DATA

N-CHANNEL ENHANCEMENT-MODE LATERAL MOSFETs

- ✓ EXCELLENT THERMAL STABILITY
- ✓ COMMON SOURCE CONFIGURATION
- ✓ P_{OUT} = 45 W PEP with 13 dB gain @ 945 MHz
- ✓ BeO FREE PACKAGE

DESCRIPTION

The SD57045-01 is a common source N-Channel Enhancement-Mode Lateral Field-Effect RF power transistor designed for broadband commercial and industrial applications at frequencies up to 1.0 GHz. The SD57045-01 is designed for high gain and broadband performance operating in common source mode at 28V. It is ideal for base stations applications requiring high linearity.

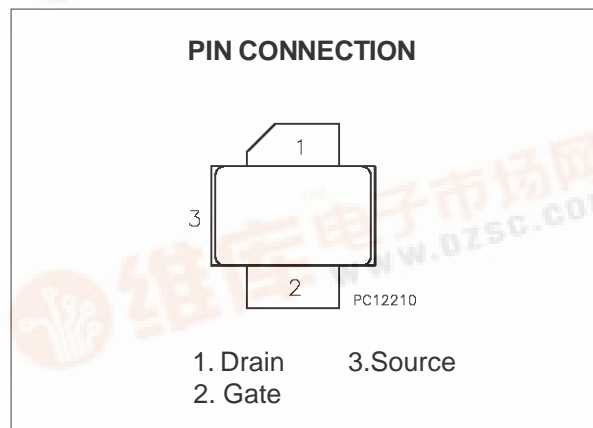
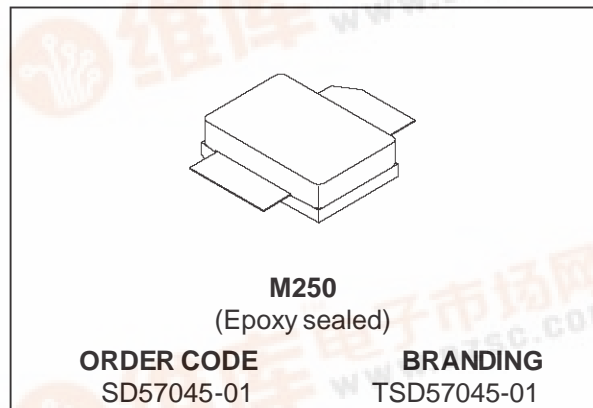

ABSOLUTE MAXIMUM RATINGS (T_{case} = 25 °C)

Symbol	Parameter	Value	Unit
V _{(BR)DSS}	Drain Source Voltage	65	V
V _{DGR}	Drain-Gate Voltage (R _{GS} = 1MΩ)	65	V
V _{GS}	Gate-Source Voltage	± 20	V
I _D	Drain Current	5	A
P _{DISS}	Power Dissipation (@ T _c = 70 °C)	93	W
T _j	Max. Operating Junction Temperature	200	°C
T _{STG}	Storage Temperature	-65 to 200	°C

THERMAL DATA (T_{case} = 70 °C)

R _{th(j-c)}	Junction-Case Thermal Resistance	1.4	°C/W
R _{th(c-s)}	Case-Heatsink Thermal Resistance	0.50	°C/W

* Determined using a flat aluminum or copper heatsink with thermal compound applied (Dow Corning 340 or equivalent).



SD57045-01

ELECTRICAL SPECIFICATION ($T_{case} = 25\text{ }^{\circ}\text{C}$)

STATIC

Symbol	Parameter		Min.	Typ.	Max.	Unit
$V_{(BR)DSS}$	$V_{GS} = 0V$	$I_{DS} = 1\text{ mA}$	65			V
I_{DSS}	$V_{GS} = 0V$	$V_{DS} = 28\text{ V}$			1	μA
I_{GSS}	$V_{GS} = 20V$	$V_{DS} = 0\text{ V}$			1	μA
$V_{GS(Q)}$	$V_{DS} = 28V$	$I_D = 250\text{ mA}$	2.5		5.0	V
$V_{DS(ON)}$	$V_{GS} = 10V$	$I_D = 3\text{ A}$		0.7	0.9	V
G_{FS}	$V_{DS} = 10V$	$I_D = 5\text{ A}$	2	2.7		mho
C_{ISS}	$V_{GS} = 0V$	$V_{DS} = 28\text{ V}$		80		pF
C_{OSS}	$V_{GS} = 0V$	$V_{DS} = 28\text{ V}$		40		pF
C_{RSS}	$V_{GS} = 0V$	$V_{DS} = 28\text{ V}$		3.2		pF

REF. 7143895B

DYNAMIC

Symbol	Parameter		Min.	Typ.	Max.	Unit
P_{OUT}	$f = 945\text{ MHz}$	$V_{DD} = 28V$ $I_{DQ} = 250\text{ mA}$	45			W
IMD_3	$V_{DD} = 28\text{ V}$	$P_{out} = 45\text{ W PEP}$ $I_{DQ} = 250\text{ mA}$		-32	-28	dBc
G_{PS}	$V_{DD} = 28\text{ V}$	$P_{out} = 45\text{ W PEP}$ $I_{DQ} = 250\text{ mA}$	13	15		dB
η_D	$V_{DD} = 28\text{ V}$	$P_{out} = 45\text{ W PEP}$ $I_{DQ} = 250\text{ mA}$	33	40		%
Load Mismatch	$f = 945\text{ MHz}$	$V_{DD} = 28\text{ V}$ $P_{out} = 45\text{ W}$ $I_{DQ} = 250\text{ mA}$ ALL PHASE ANGLES	10:1			VSWR

Note: $f_1 = 945.0\text{ MHz}$
 $f_2 = 945.1\text{ MHz}$

IMPEDANCE DATA

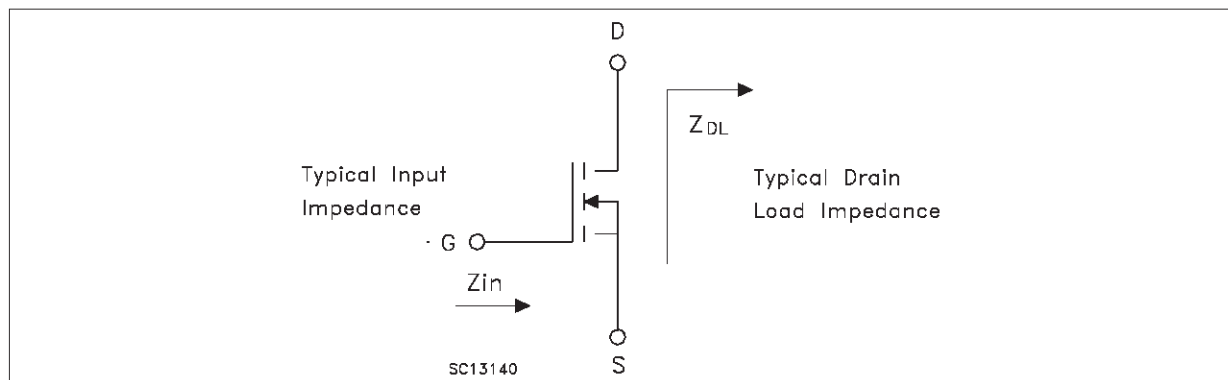

FREQ.	$Z_{IN} (\Omega)$	$Z_{DL} (\Omega)$
925 MHz	$1.27 + j 0.82$	$2.22 - j 1.63$
930 MHz	$1.21 + j 0.79$	$2.24 - j 1.61$
945 MHz	$1.04 + j 0.71$	$2.30 - j 1.52$
960 MHz	$0.93 + j 0.43$	$2.37 - j 1.37$
965 MHz	$0.91 + j 0.41$	$2.43 - j 1.36$

TYPICAL PERFORMANCE

Capacitance vs Drain-Source Voltage

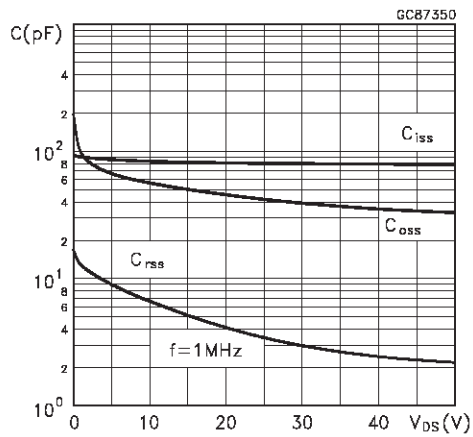

Gate-Source Voltage vs Case Temperature

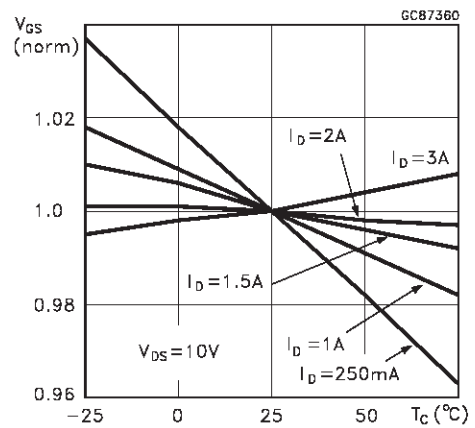

Drain Current vs Gate Voltage

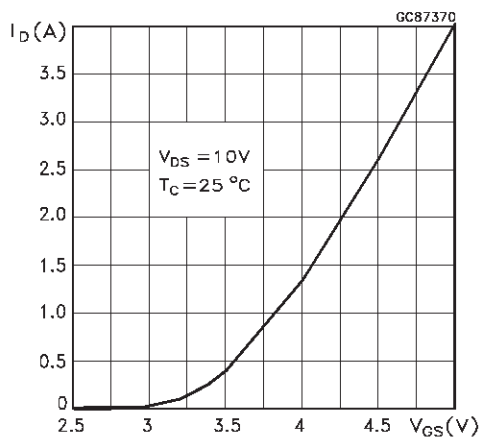

DC Maximum Safe Operating Area

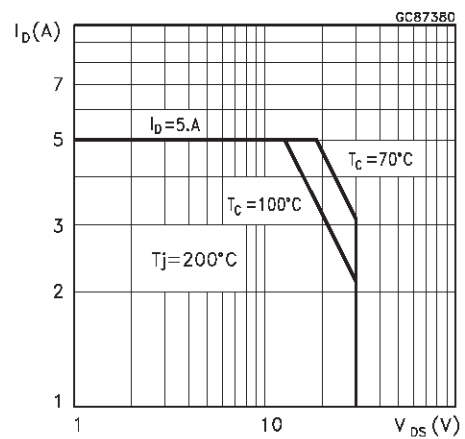

Maximum Thermal Resistance vs Case Temperature

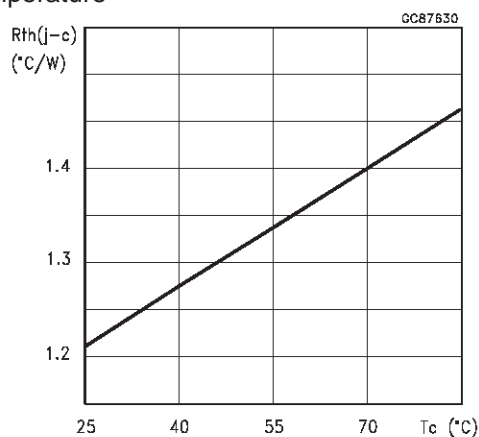

TYPICAL PERFORMANCE (CW)

Output Power and Power Gain vs Input Power

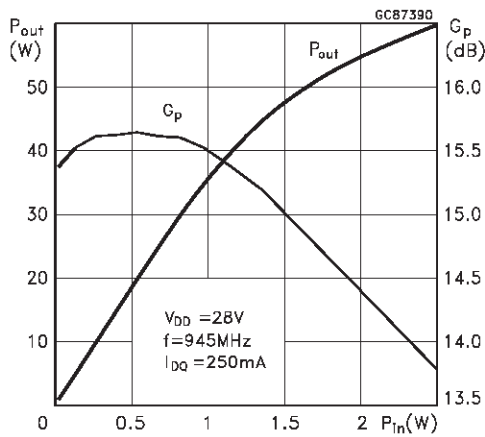

Power Gain vs Output Power

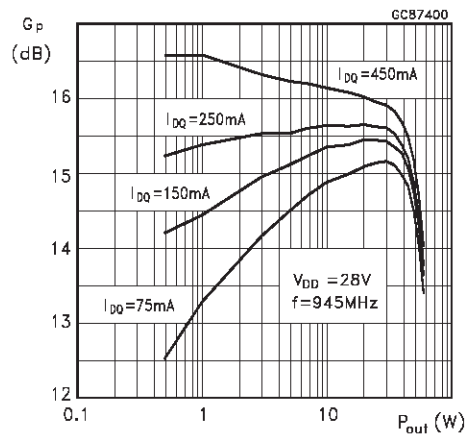

Efficiency vs Output Power

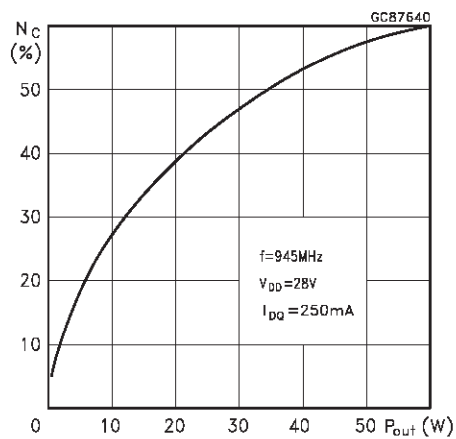

Broadband Power Performance

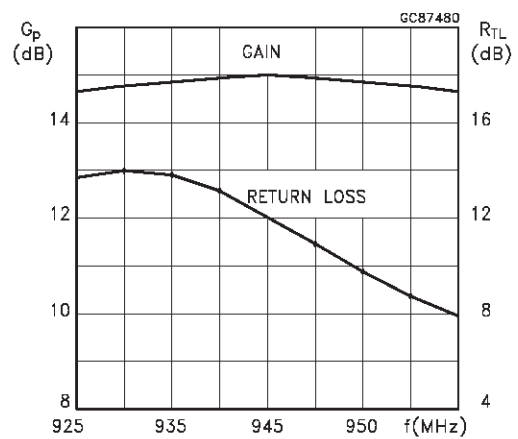

Output Power vs. Drain Voltage

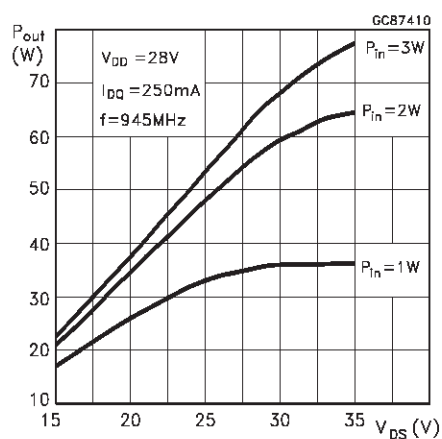

Output Power vs. Gate Bias Voltage

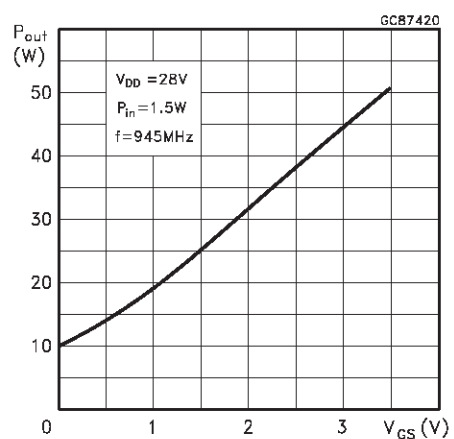

TYPICAL PERFORMANCE (PEP)

Output Power and Power Gain vs Input Power

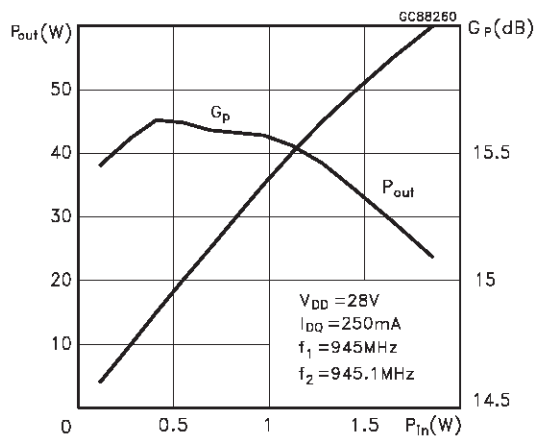

Efficiency vs Output Power

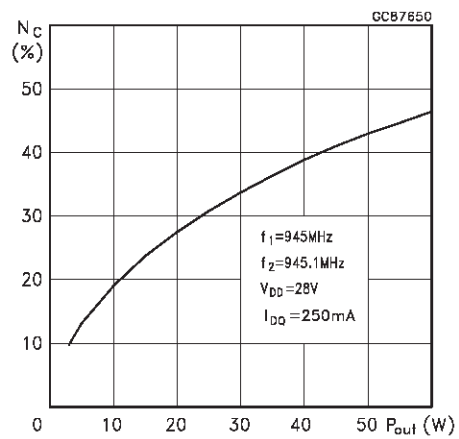

Intermodulation Distortion vs. Output Power

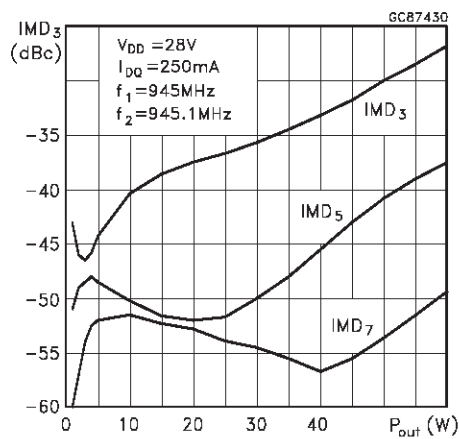

Intermodulation Distortion vs. Output Power

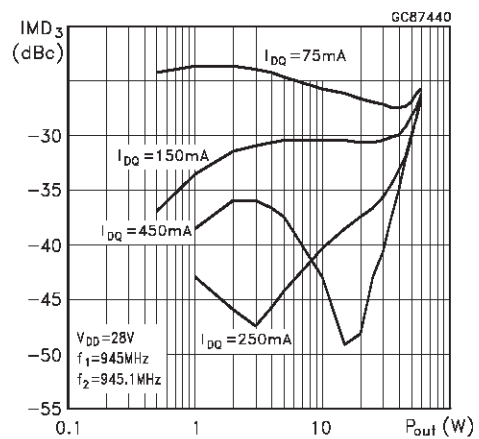

Class A Third Order Intercept Point

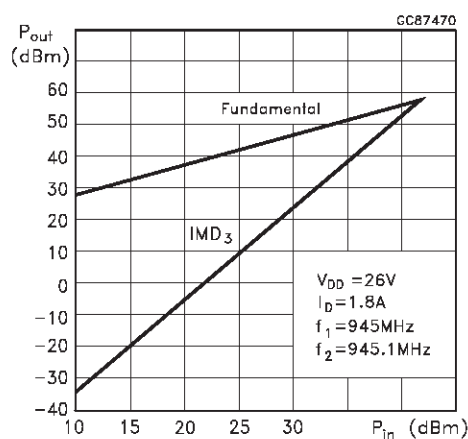

SD57045-01

945 MHz Test Circuit Schematic

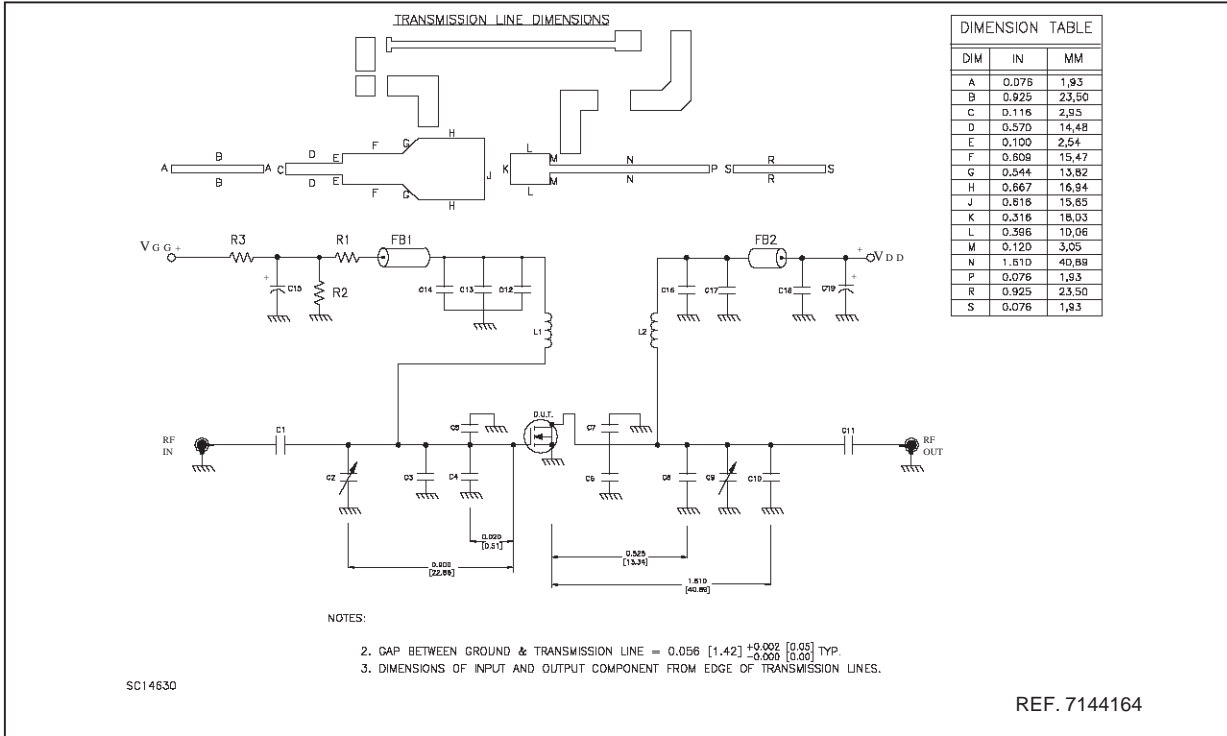

945 MHz Test Circuit Component Part List

COMPONENT	PART NO	VENDOR	DESCRIPTION
C19	SME63VB221M10X20L	UNITED CHEMI-CON	220µF/63V ALUMINUM ELECTROLYTIC RADIAL LEAD CAPACITOR
C18	C1812X7R501-104KNE	VENKEL	0.1µF/500V SURFACE MOUNT CERAMIC CHIP CAPACITOR
C17	ATC100B101KW500X	ATC	100pF ATC 100B SURFACE MOUNT CERAMIC CHIP CAPACITOR
C16	ATC100B470KW500X	ATC	47pF ATC 100B SURFACE MOUNT CERAMIC CHIP CAPACITOR
C15	SKR100M1JD11	MALLORY	10µF/50V ALUMINUM ELECTROLYTIC RADIAL LEAD CAPACITOR
C14	C1812X7R501-104KNE	VENKEL	0.1µF/500V SURFACE MOUNT CERAMIC CHIP CAPACITOR
C13	ATC700B102MW50X	ATC	1000pF ATC 700B SURFACE MOUNT CERAMIC CHIP CAPACITOR
C12	ATC100B470KW500X	ATC	47pF ATC 100B SURFACE MOUNT CERAMIC CHIP CAPACITOR
C11	ATC100B470KW500X	ATC	47pF ATC 100B SURFACE MOUNT CERAMIC CHIP CAPACITOR
C10	ATC100B3R0KW500X	ATC	3.0pF ATC 100B SURFACE MOUNT CERAMIC CHIP CAPACITOR
C9	27291PC	JOHANSON	0.8-8.0pF GIGA TRIM VARIABLE CAPACITOR
C8	ATC100B6R2KW500X	ATC	6.2pF ATC 100B SURFACE MOUNT CERAMIC CHIP CAPACITOR
C7	ATC100B100KW500X	ATC	10pF ATC 100B SURFACE MOUNT CERAMIC CHIP CAPACITOR
C6	ATC100B100KW500X	ATC	10pF ATC 100B SURFACE MOUNT CERAMIC CHIP CAPACITOR
C5	ATC100B100KW500X	ATC	10pF ATC 100B SURFACE MOUNT CERAMIC CHIP CAPACITOR
C4	ATC100B100KW500X	ATC	10pF ATC 100B SURFACE MOUNT CERAMIC CHIP CAPACITOR
C3	ATC100B3R0CW500X	ATC	3pF ATC 100B SURFACE MOUNT CERAMIC CHIP CAPACITOR
C2	27291PC	JOHANSON	0.8-8.0pF GIGA TRIM VARIABLE CAPACITOR
C1	ATC100B470KW500X	ATC	47pF ATC 100B SURFACE MOUNT CERAMIC CHIP CAPACITOR
R3	CR2010-2W-475JT	VENKEL	120 OHM, 2W SURFACE MOUNT CHIP RESISTOR
R2	CR2512-1W-183JT	VENKEL	4.7M OHM 1W SURFACE MOUNT CHIP RESISTOR
R1	CR2512-1W-121JT	VENKEL	18K OHM, 1W SURFACE MOUNT CHIP RESISTOR
FB2	2743021447	FAIR-RITE CORP.	SHIELD BEAD SURFACE MOUNT EMI
FB1	2743019447	FAIR-RITE CORP.	SHIELD BEAD SURFACE MOUNT EMI
L2	8051	BELDEN	INDUCTOR, 5TURNS AIR WOUND #22AWG, ID=0.059[1.49], NYLON COATED MAGNET WIRE
L1	8051	BELDEN	INDUCTOR, 5TURNS AIR WOUND #22AWG, ID=0.059[1.49], NYLON COATED MAGNET WIRE
PCB	G0300M1026	ROGERS CORP.	WOVEN FIBERGLASS REINFORCED PTFE 0.080" THK, εr=2.55, 2 Oz EDCu BOTH SIDE
COMPONENT	PART NO	VENDOR	DESCRIPTION

SC14640

945 MHz Test Circuit Photomaster

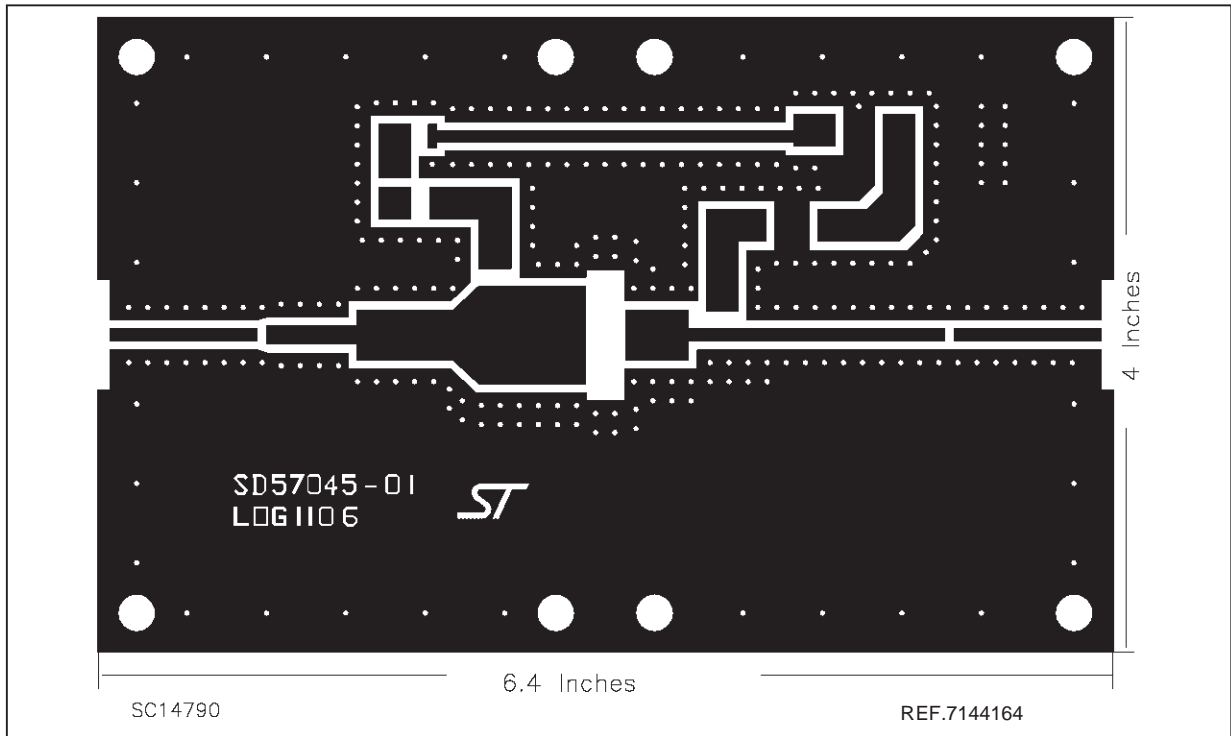

945 MHz Production Test Fixture

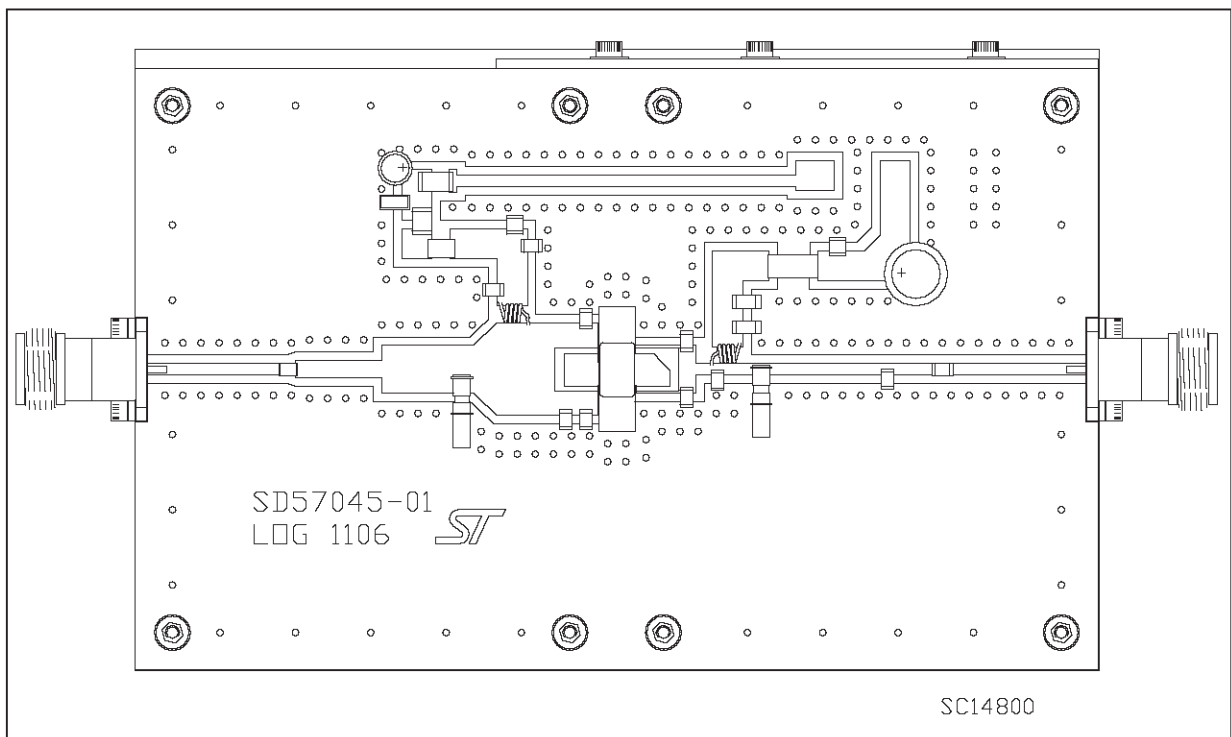

SD57045-01

COMMON SOURCE S-PARAMETERS

($V_{DS} = 13.5\text{ V}$, $I_{DS} = 1.5\text{ A}$)

FREQ (MHz)	$ S_{11} $	$\angle S_{11}$	$ S_{21} $	$\angle S_{21}$	$ S_{12} $	$\angle S_{12}$	$ S_{22} $	$\angle S_{22}$
50	0.902	-168	14.591	88	0.015	-4	0.781	-170
60	0.902	-169	13.845	88	0.015	-4	0.781	-170
70	0.902	-168	13.069	87	0.014	-5	0.781	-171
80	0.902	-170	12.266	86	0.014	-5	0.781	-171
90	0.902	-170	11.436	86	0.014	-5	0.782	-171
100	0.903	-171	10.587	84	0.014	-6	0.782	-172
150	0.905	-173	6.604	78	0.014	-9	0.788	-173
200	0.910	-174	4.670	71	0.013	-11	0.799	-173
250	0.916	-174	3.588	66	0.013	-12	0.812	-173
300	0.921	-174	2.884	61	0.012	-11	0.825	-173
350	0.927	-175	2.379	56	0.011	-13	0.839	-173
400	0.933	-175	2.005	52	0.011	-14	0.853	-173
450	0.939	-175	1.719	48	0.010	-14	0.866	-173
500	0.944	-175	1.494	45	0.010	-15	0.878	-173
550	0.950	-175	1.317	42	0.009	-14	0.889	-173
600	0.954	-175	1.169	40	0.008	-12	0.899	-173
650	0.957	-175	1.051	38	0.007	-10	0.908	-174
700	0.960	-175	0.942	36	0.007	-5	0.916	-174
750	0.963	-175	0.853	34	0.006	-1	0.923	-174
800	0.966	-175	0.770	32	0.005	7	0.930	-174
850	0.968	-176	0.696	31	0.005	16	0.935	-174
900	0.970	-176	0.630	29	0.005	28	0.940	-174
950	0.972	-176	0.568	28	0.005	40	0.944	-174
1000	0.973	-176	0.515	27	0.005	50	0.948	-174
1050	0.974	-176	0.465	26	0.006	59	0.950	-174
1100	0.926	-177	0.422	25	0.006	66	0.950	-174
1150	0.977	-177	0.301	25	0.007	74	0.949	-175
1200	0.979	-177	0.348	24	0.008	79	0.946	-176
1250	0.980	-177	0.317	24	0.009	83	0.941	-177
1300	0.982	-177	0.292	24	0.010	84	0.934	-178
1350	0.984	-177	0.267	24	0.011	85	0.923	180
1400	0.986	-177	0.248	24	0.012	86	0.910	177
1450	0.989	-177	0.231	24	0.013	87	0.892	175
1500	0.990	-177	0.223	25	0.013	88	0.898	172

COMMON SOURCE S-PARAMETERS

(V_{DS} = 28 V, I_{DS} = 1.5 A)

FREQ (MHz)	S ₁₁	∠S ₁₁	S ₂₁	∠S ₂₁	S ₁₂	∠S ₁₂	S ₂₂	∠S ₂₂
50	0.867	-158	20.011	91	0.013	2	0.675	-163
60	0.870	-159	18.979	90	0.013	1	0.676	-164
70	0.873	-160	17.907	89	0.013	-0	0.677	-164
80	0.876	-162	16.794	88	0.013	-1	0.679	-165
90	0.880	-163	15.649	87	0.013	-2	0.681	-165
100	0.884	-164	14.478	86	0.013	-3	0.683	-165
150	0.904	-169	8.997	77	0.012	-9	0.700	-167
200	0.915	-171	6.310	70	0.012	-14	0.722	-167
250	0.920	-172	4.797	62	0.011	-18	0.748	-167
300	0.927	-173	3.813	56	0.010	-21	0.774	-167
350	0.933	-173	3.106	51	0.009	-22	0.799	-167
400	0.940	-173	2.589	47	0.009	-23	0.823	-168
450	0.947	-174	2.194	43	0.008	-23	0.843	-168
500	0.953	-174	1.890	40	0.007	-23	0.862	-168
550	0.958	-174	1.652	37	0.006	-21	0.877	-169
600	0.963	-174	1.456	34	0.006	-17	0.891	-169
650	0.966	-174	1.299	32	0.005	-12	0.904	-169
700	0.968	-175	1.157	30	0.004	-4	0.914	-170
750	0.971	-175	1.039	28	0.004	6	0.923	-170
800	0.974	-175	0.932	26	0.004	18	0.932	-170
850	0.976	-175	0.838	25	0.004	31	0.940	-172
900	0.977	-176	0.755	23	0.004	42	0.946	-170
950	0.979	-176	0.678	22	0.004	54	0.951	-170
1000	0.980	-176	0.613	21	0.005	61	0.955	-171
1050	0.981	-176	0.550	20	0.006	69	0.957	-171
1100	0.982	-177	0.498	19	0.006	74	0.958	-171
1150	0.983	-177	0.449	19	0.007	28	0.957	-172
1200	0.985	-177	0.410	19	0.008	80	0.954	-173
1250	0.985	-177	0.373	18	0.009	83	0.949	-174
1300	0.986	-177	0.344	18	0.010	86	0.940	-175
1350	0.987	-177	0.314	18	0.010	88	0.929	-177
1400	0.989	-177	0.292	19	0.011	90	0.913	-180
1450	0.991	-177	0.273	19	0.012	93	0.896	-177
1500	0.992	-177	0.263	19	0.013	94	0.884	-175

M250 (.230 x .360 WIDE 2/L N/HERM PILL) MECHANICAL DATA

DIM.	mm			inch		
	MIN.	TYP.	MAX.	MIN.	TYP.	MAX.
A	5.21		5.71	0.205		0.225
B	2.16		2.92	0.085		0.115
C	5.59		6.09	0.220		0.240
D	8.89		9.40	0.350		0.370
E	9.40		9.91	0.370		0.390
F	0.11		0.15	0.004		0.006
G	0.89		1.14	0.035		0.045
H	1.45		1.70	0.057		0.067
I	2.67		3.94	0.105		0.155

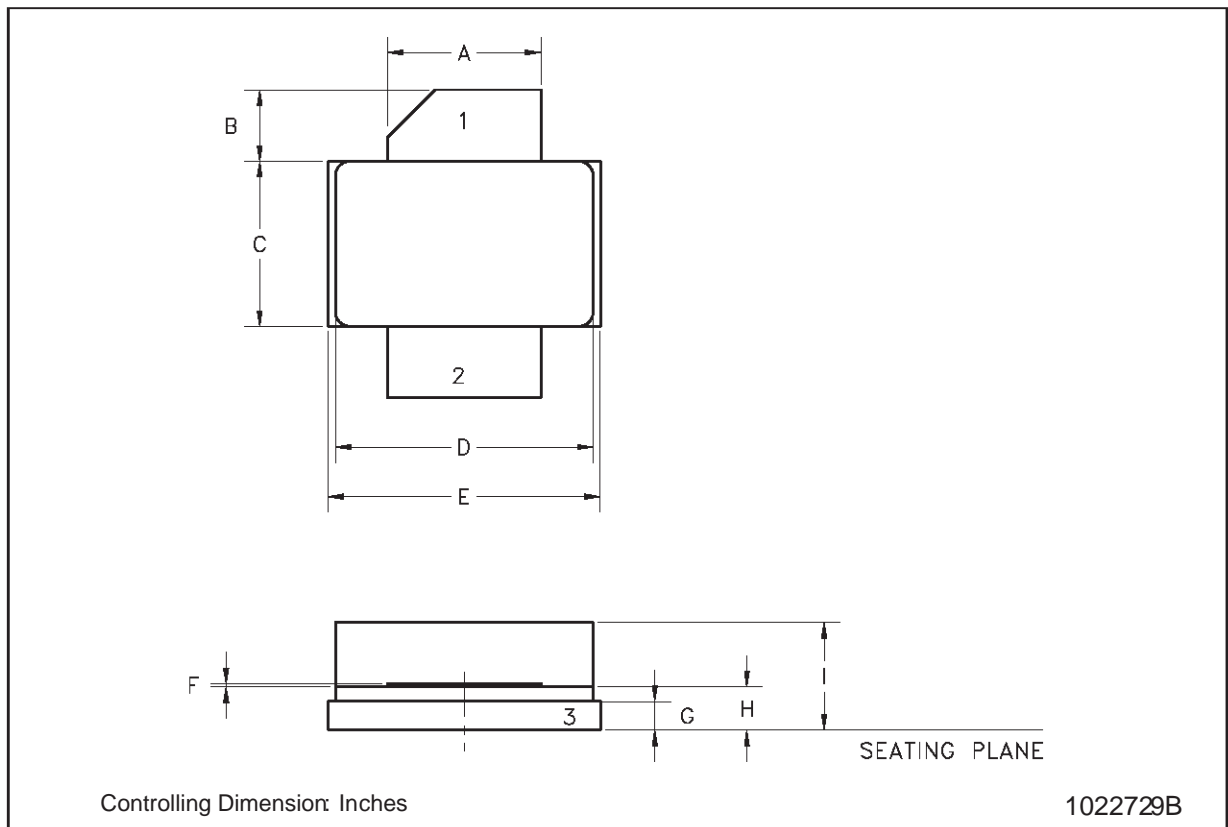

Information furnished is believed to be accurate and reliable. However, STMicroelectronics assumes no responsibility for the consequences of use of such information nor for any infringement of patents or other rights of third parties which may result from its use. No license is granted by implication or otherwise under any patent or patent rights of STMicroelectronics. Specification mentioned in this publication are subject to change without notice. This publication supersedes and replaces all information previously supplied. STMicroelectronics products are not authorized for use as critical components in life support devices or systems without express written approval of STMicroelectronics.

The ST logo is a trademark of STMicroelectronics

© 2000 STMicroelectronics – Printed in Italy – All Rights Reserved

STMicroelectronics GROUP OF COMPANIES

Australia - Brazil - China - Finland - France - Germany - Hong Kong - India - Italy - Japan - Malaysia - Malta - Morocco -
Singapore - Spain - Sweden - Switzerland - United Kingdom - U.S.A.

<http://www.st.com>