

Features

- Low Forward Voltage Drop
- Guard Ring Die Construction for Transient Protection
- Ideal for low logic level applications
- Low Capacitance
- **Lead Free/RoHS Compliant (Note 3)**

Mechanical Data

- Case: SOT-523
- Case Material: Molded Plastic. UL Flammability Classification Rating: 94V-0
- Moisture Sensitivity: Level 1 per J-STD-020C
- Terminals: Solderable per MIL-STD-202, Method 208
- Lead Free Plating (Matte Tin Finish annealed over Alloy 42 leadframe).
- Polarity: See Diagrams Below
- Marking: See Diagrams Below & Page 3
- Weight: 0.002 grams (approx.)
- Ordering Information, see Page 3

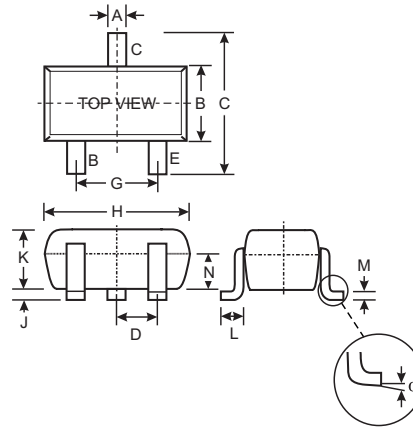

SOT-523			
Dim	Min	Max	Typ
A	0.15	0.30	0.22
B	0.75	0.85	0.80
C	1.45	1.75	1.60
D	—	—	0.50
G	0.90	1.10	1.00
H	1.50	1.70	1.60
J	0.00	0.10	0.05
K	0.60	0.80	0.75
L	0.10	0.30	0.22
M	0.10	0.20	0.12
N	0.45	0.65	0.50
α	0°	8°	—
All Dimensions in mm			

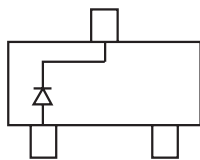

SDMP0340LT Marking: SM

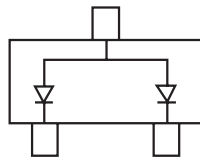

SDMP0340LAT Marking: SQ

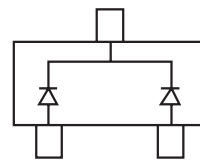

SDMP0340LCT Marking: SP

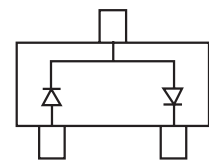

SDMP0340LST Marking: SN

Maximum Ratings @ T_A = 25°C unless otherwise specified

Characteristic	Symbol	Value	Unit
Peak Repetitive Reverse Voltage Working Peak Reverse Voltage DC Blocking Voltage	V _{RRM} V _{RWM} V _R	40	V
RMS Reverse Voltage	V _{R(RMS)}	28	V
Forward Continuous Current (Note 1)	I _{FM}	30	mA
Non-Repetitive Peak Forward Surge Current @8.3ms Single half sine-wave superimposed on rated load (JEDEC method)	I _{FSM}	200	mA
Power Dissipation (Note 1)	P _d	150	mW
Thermal Resistance, Junction to Ambient (Note 1)	R _{θJA}	833	°C/W
Operating and Storage Temperature Range	T _j , T _{STG}	-40 to +125	°C

Electrical Characteristics @ T_A = 25°C unless otherwise specified

Characteristic	Symbol	Min	Typ	Max	Unit	Test Condition
Reverse Breakdown Voltage (Note 2)	V _{(BR)R}	40	—	—	V	I _R = 10uA
Forward Voltage Drop (Note 2)	V _F	—	290	370	mV	I _F = 1mA
Leakage Current (Note 2)	I _R	—	—	1.0	μA	V _R = 10V
Total Capacitance	C _T	—	2	—	pF	V _R = 1V, f = 1.0 MHz

- Notes: 1. Device mounted on FR-4 PC board with recommended pad layout, which can be found on our website at <http://www.diodes.com/datasheets/ap02001.pdf>.
 2. Short duration test pulse used to minimize self-heating effect.
 3. No purposefully added lead.

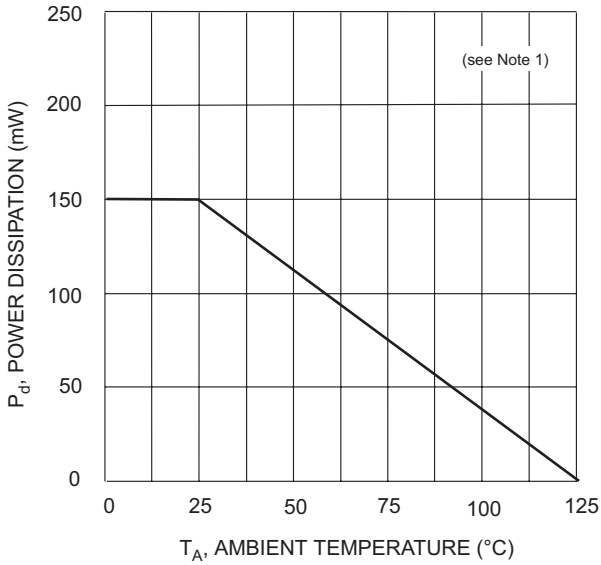

Fig. 1, Power Derating Curve

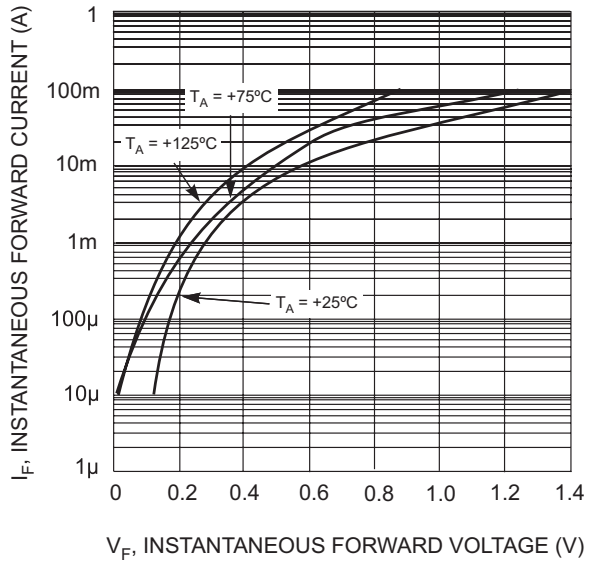

Fig. 2, Typical Forward Characteristics

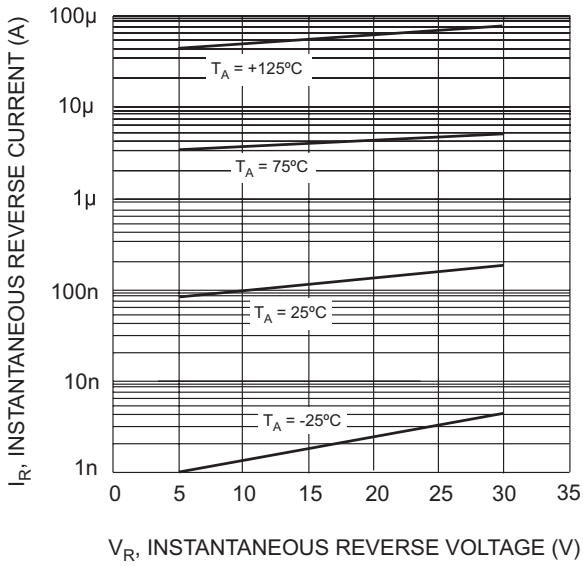

Fig. 3, Typical Reverse Characteristics

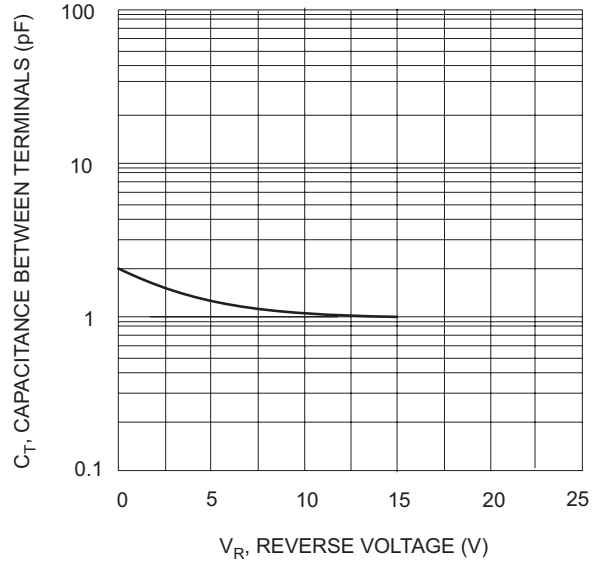

Fig. 4, Typical Capacitance Between Terminals Characteristics

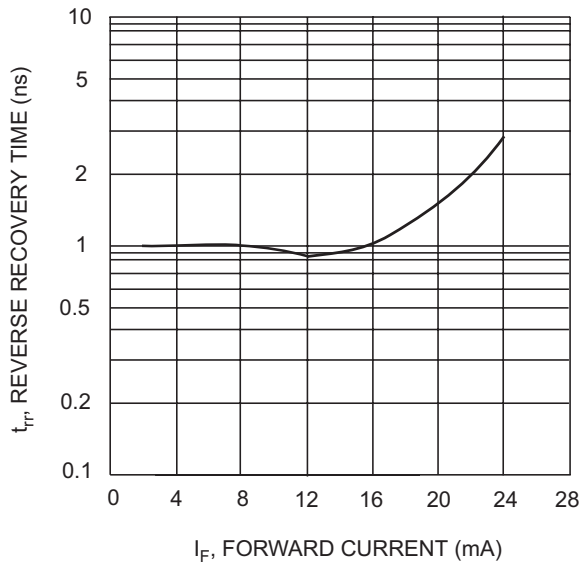

Fig. 5, Typical Reverse Recovery Time Characteristics

Ordering Information (Note 4)

Device	Packaging	Shipping
SDMP0340LT-7	SOT-523	3000/Tape & Reel
SDMP0340LST-7	SOT-523	3000/Tape & Reel
SDMP0340LCT-7	SOT-523	3000/Tape & Reel
SDMP0340LAT-7	SOT-523	3000/Tape & Reel

Notes: 4. For Packaging Details: go to our website at <http://www.diodes.com/datasheets/ap02007.pdf>.

Marking Information

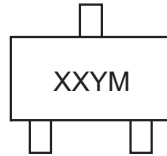

XX = Product Type Marking Code (See Page 1)
 YM = Date Code Marking
 Y = Year (ex: N = 2002)
 M = Month (ex: 9 = September)

Date Code Key

Year	2001	2002	2003	2004	2005	2006	2007	2008	2009
Code	M	N	P	R	S	T	U	V	W

Month	Jan	Feb	March	Apr	May	Jun	Jul	Aug	Sep	Oct	Nov	Dec
Code	1	2	3	4	5	6	7	8	9	O	N	D

IMPORTANT NOTICE

Diodes, Inc. and its subsidiaries reserve the right to make changes without further notice to any product herein to make corrections, modifications, enhancements, improvements, or other changes. Diodes, Inc. does not assume any liability arising out of the application or use of any product described herein; neither does it convey any license under its patent rights, nor the rights of others. The user of products in such applications shall assume all risks of such use and will agree to hold Diodes Incorporated and all the companies whose products are represented on our website, harmless against all damages.

LIFE SUPPORT

The products located on our website at www.diodes.com are not recommended for use in life support systems where a failure or malfunction of the component may directly threaten life or cause injury without the expressed written approval of Diodes Incorporated.