

SHINDENGEN

Schottky Rectifiers (SBD)

Dual

SF15SC4

40V 15A

OUTLINE DIMENSIONS

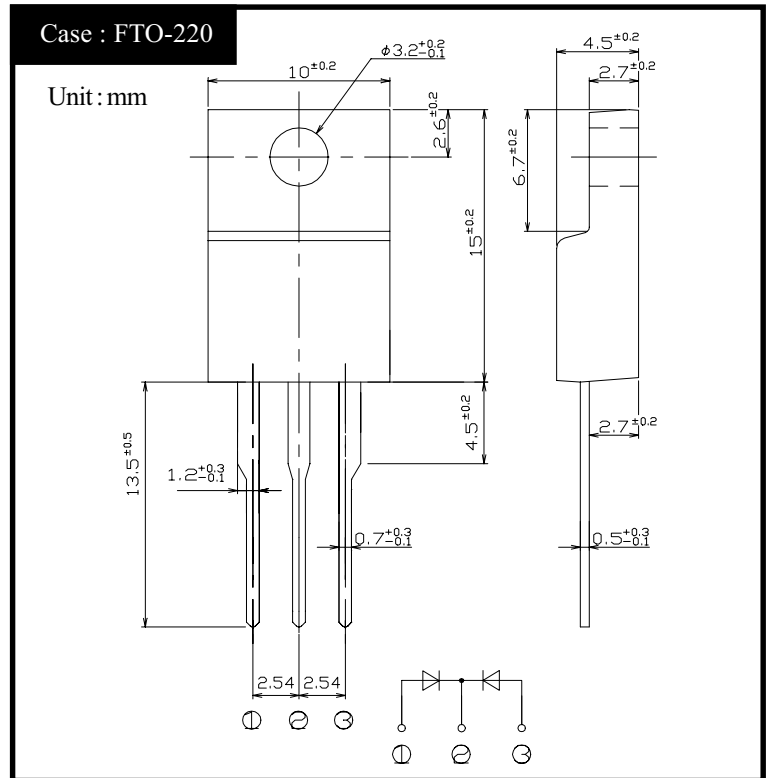

RATINGS

● Absolute Maximum Ratings (Unless otherwise specified, Tc=25°C)

Item	Symbol	Conditions	Ratings	Unit
Storage Temperature	Tstg		-55~150	°C
Operating Junction Temperature	Tj		150	°C
Maximum Reverse Voltage	V _{RM}		40	V
Repetitive Peak Surge Reverse Voltage	V _{RRSM}	Pulse width 0.5ms, duty 1/40	45	V
Average Rectified Forward Current	I _O	50Hz sine wave, R-load, Rating for each diode I _O /2, Tc=125°C	15	A
Peak Surge Forward Current	I _{FSM}	50Hz sine wave, Non-repetitive 1 cycle peak value, Tj=25°C	200	A
Repetitive Peak Surge Reverse Power	P _{RRSM}	Pulse width 10 μs, Rating of per diode, Tj=25°C	330	W
Dielectric Strength	V _{dis}	Terminals to case, AC 1 minute	2	kV
Mounting Torque	TOR	(Recommended torque: 0.3N·m)	0.5	N·m

● Electrical Characteristics (Unless otherwise specified, Tc=25°C)

Item	Symbol	Conditions	Ratings	Unit
Forward Voltage	V _F	I _F =7.5A, Pulse measurement, Rating of per diode	Max 0.55	V
Reverse Current	I _R	V _R =V _{RM} , Pulse measurement, Rating of per diode	Max 5.0	mA
Junction Capacitance	C _j	f=1MHz, V _R =10V, Rating of per diode	Typ 340	pF
Thermal Resistance	θ _{jc}	junction to case	Max 2.0	°C/W
	θ _{jf}	junction to heatsink	Max 4.5	°C/W
	θ _{cf}	case to heatsink	Max 2.5	°C/W

SF15SC4 Forward Voltage

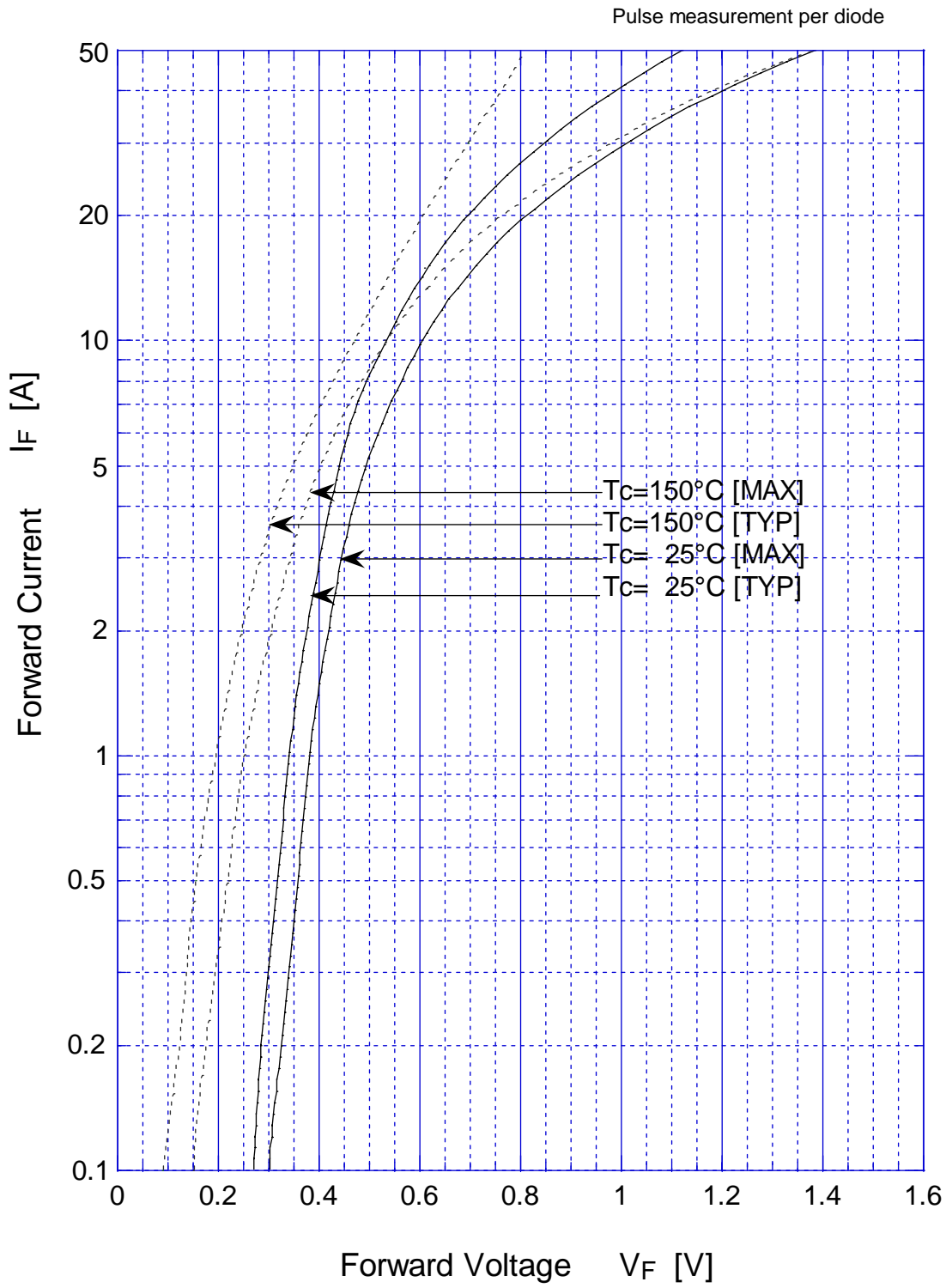

SF15SC4 Reverse Current

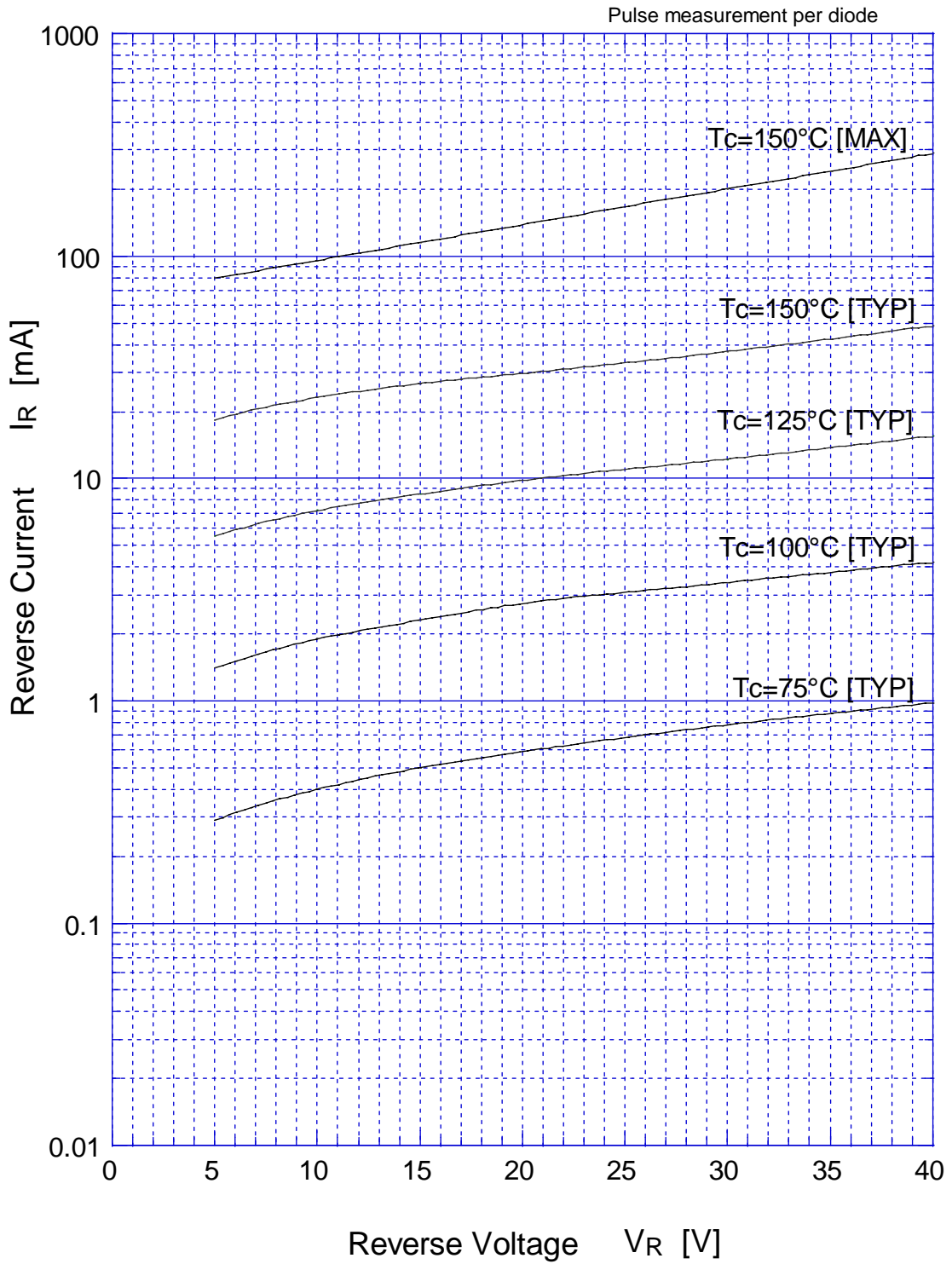

SF15SC4 Forward Power Dissipation

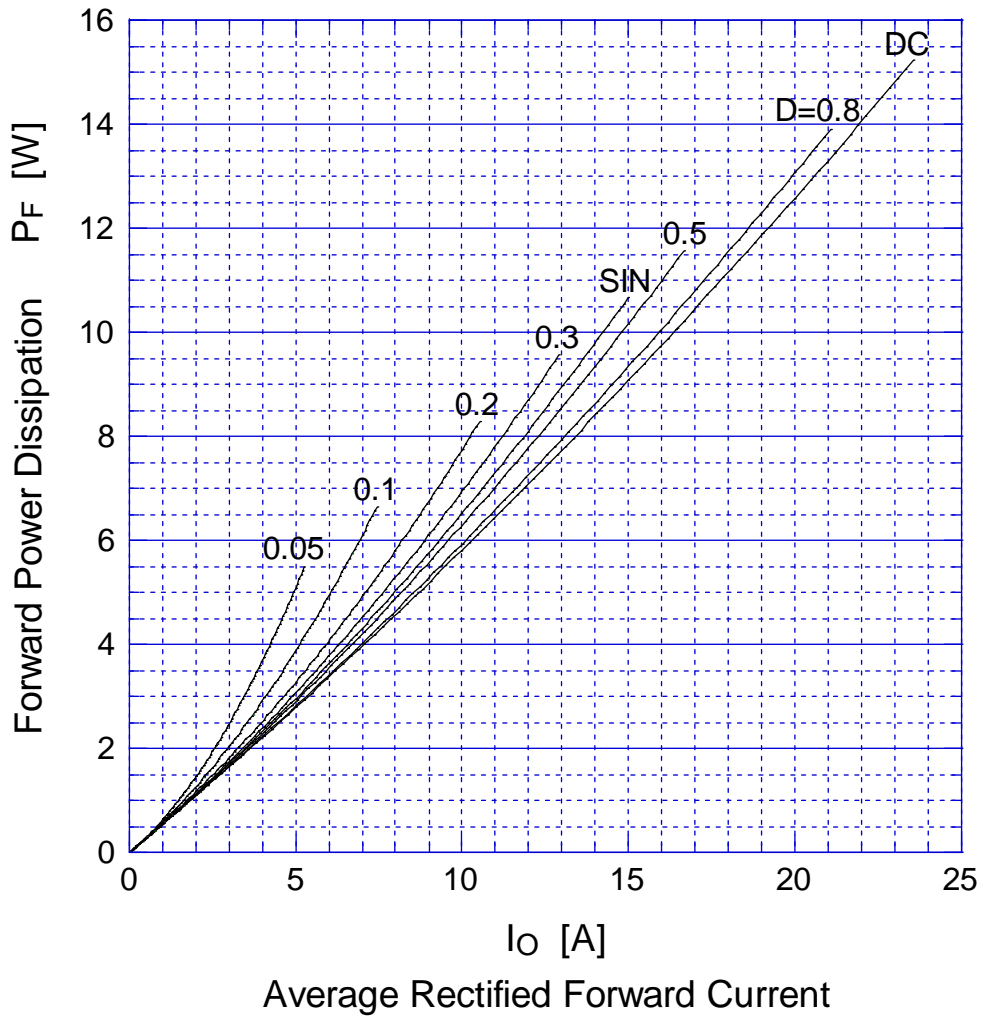

$T_j = 150^\circ\text{C}$

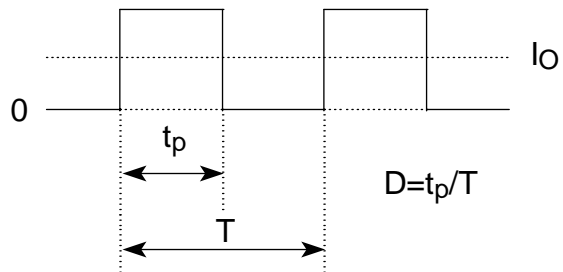

SF15SC4 Reverse Power Dissipation

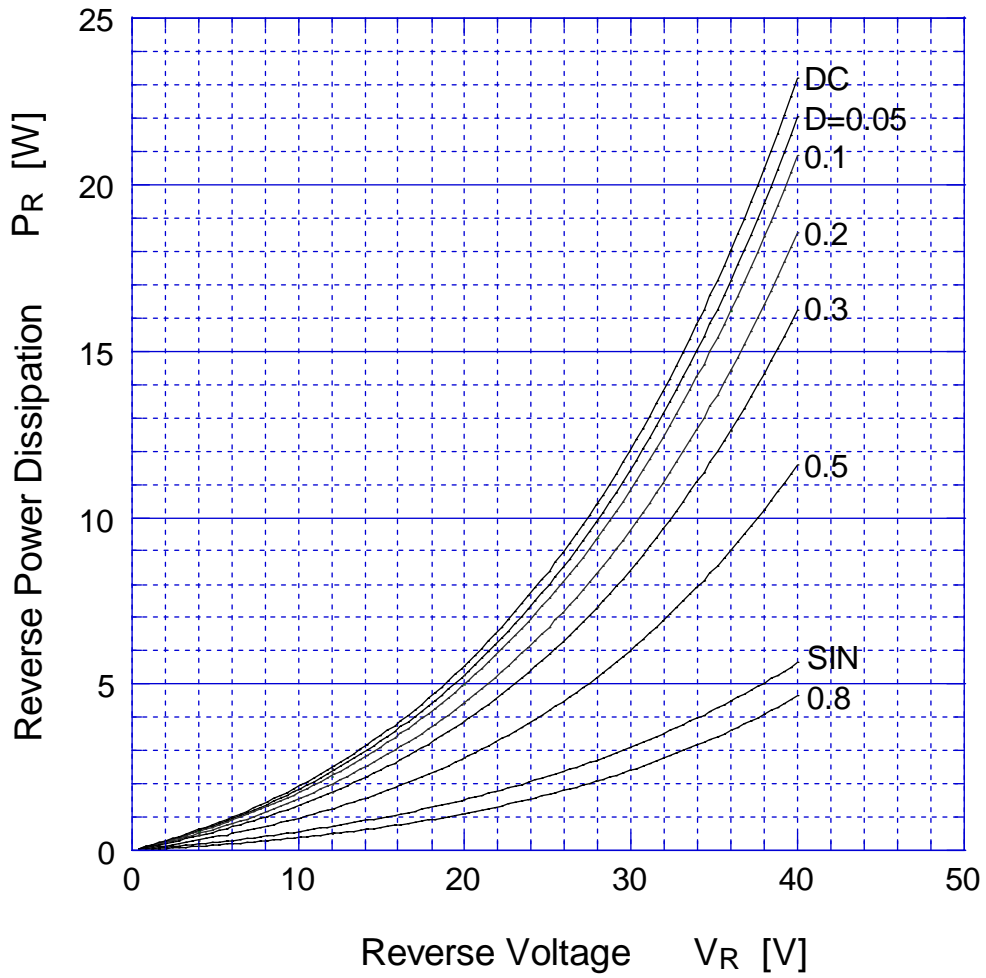

$T_j = 150^\circ\text{C}$

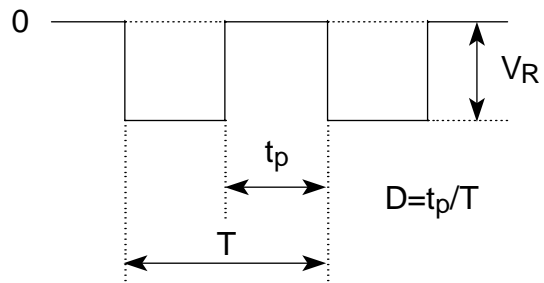

SF15SC4

Derating Curve

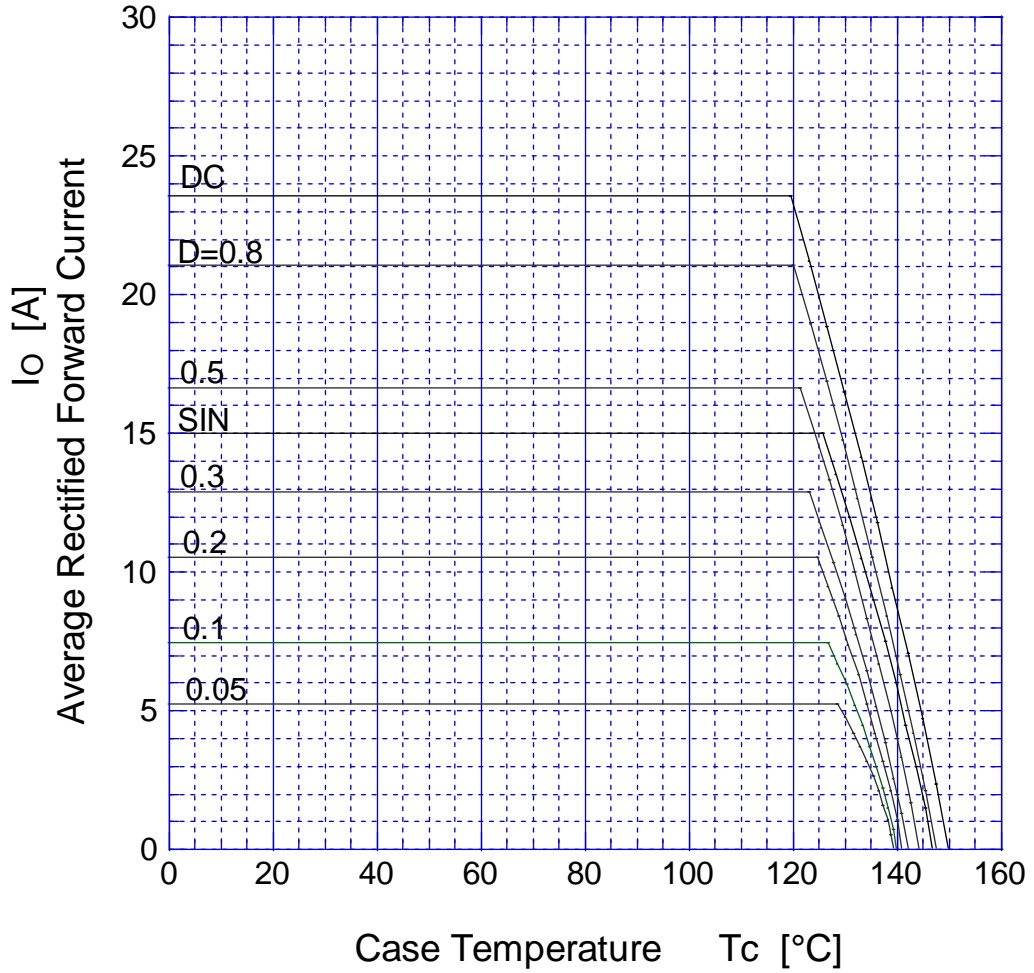

$V_R = 20V$

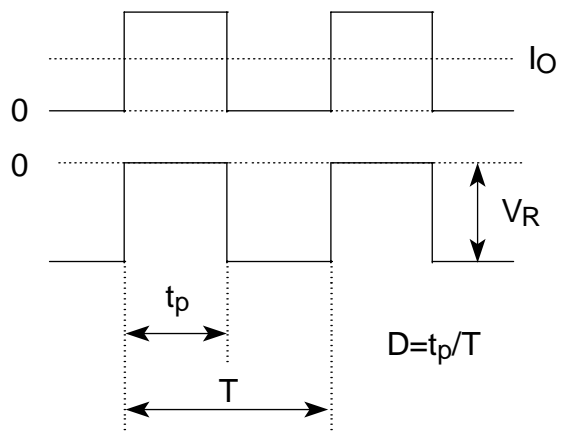

SF15SC4 Peak Surge Forward Capability

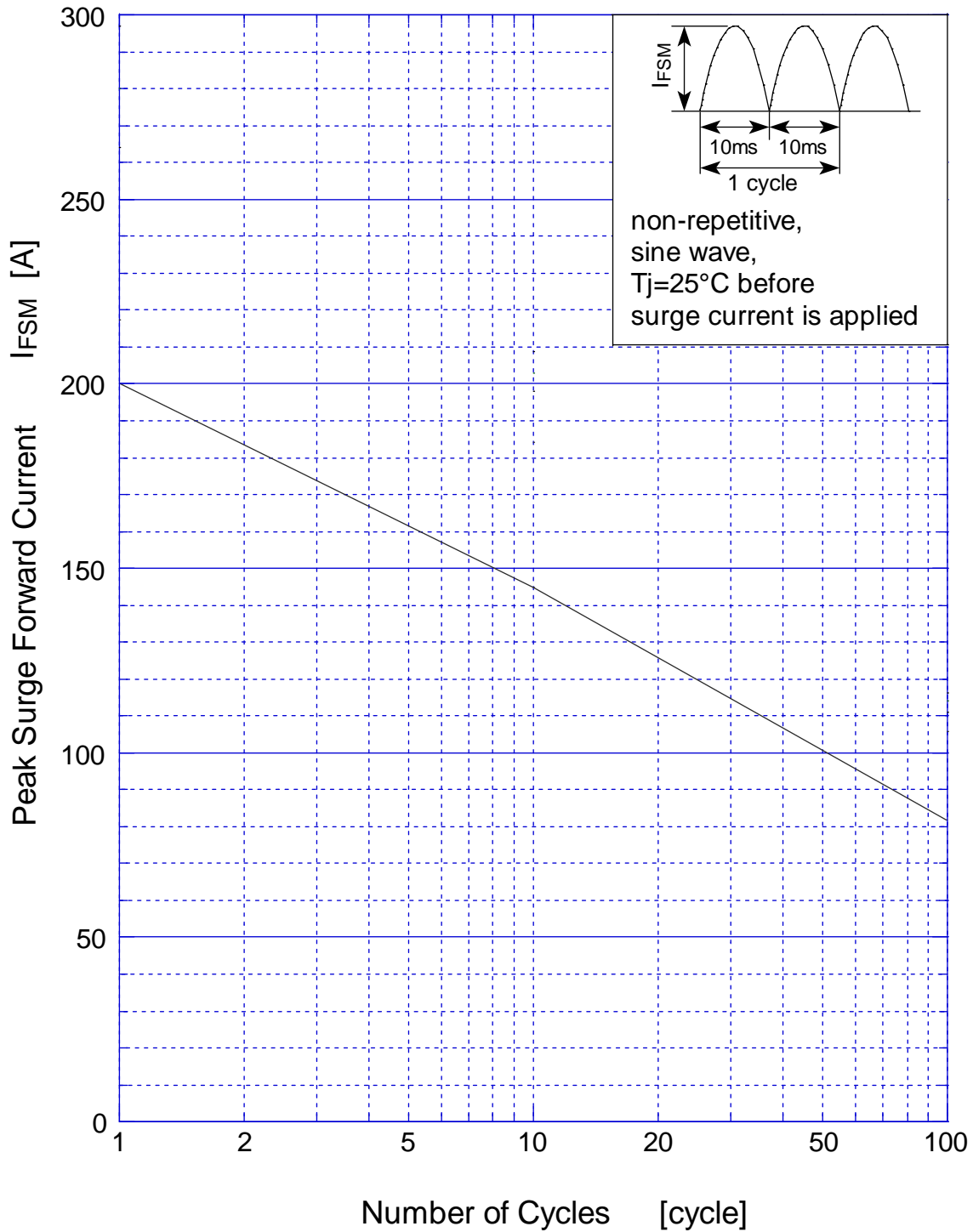

SF15SC4 Junction Capacity

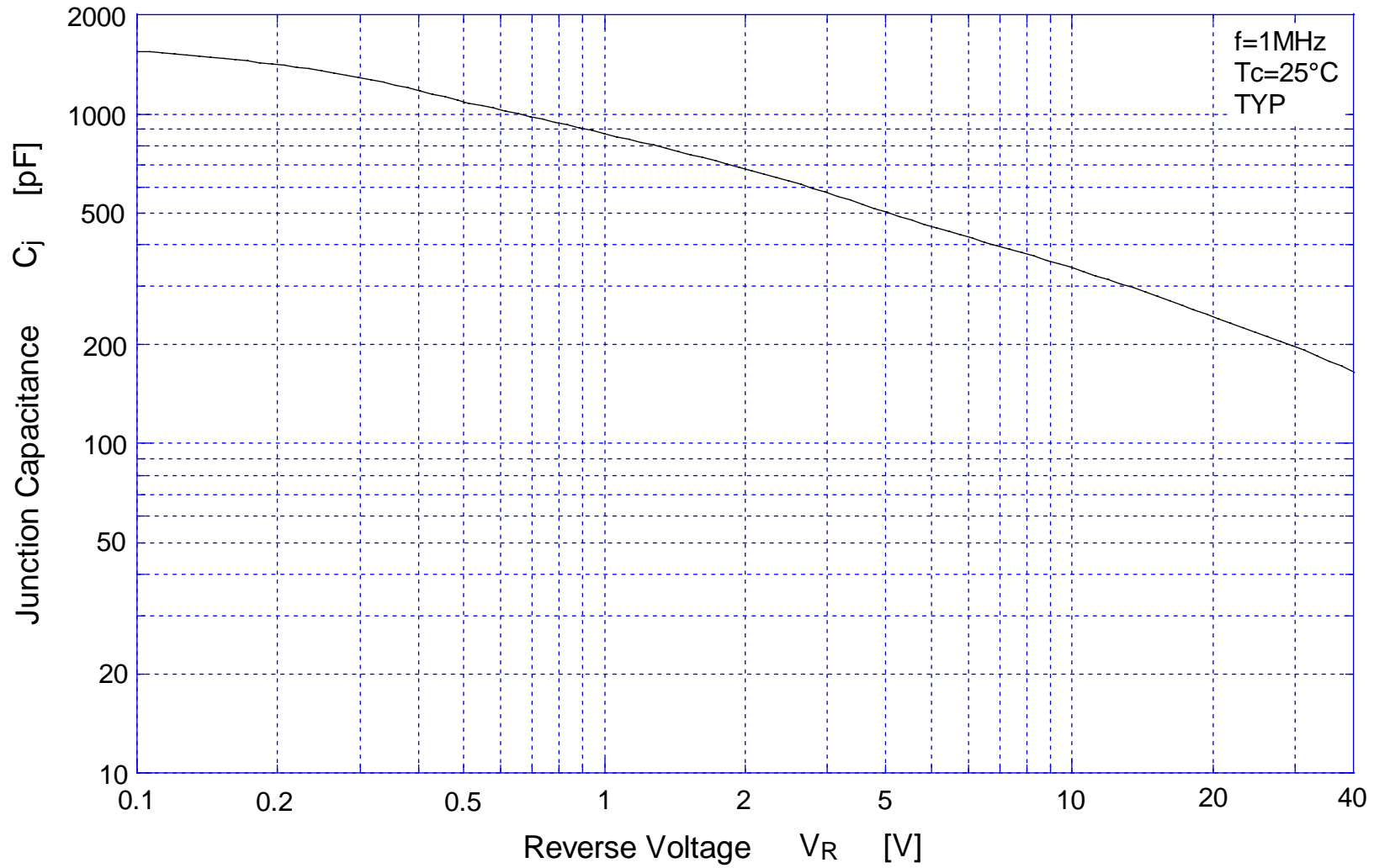

SF15SC4 Repetitive Surge Reverse Power Capability

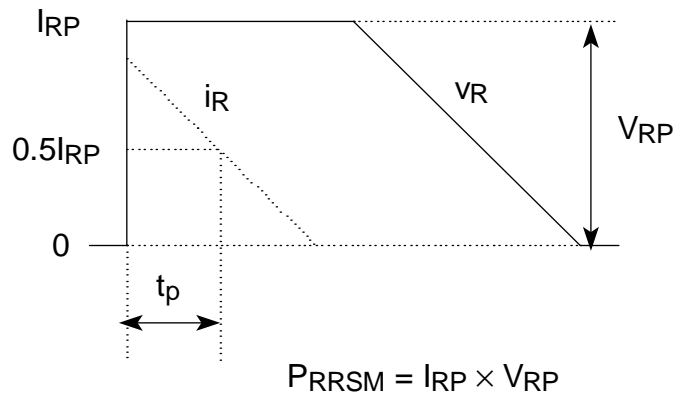
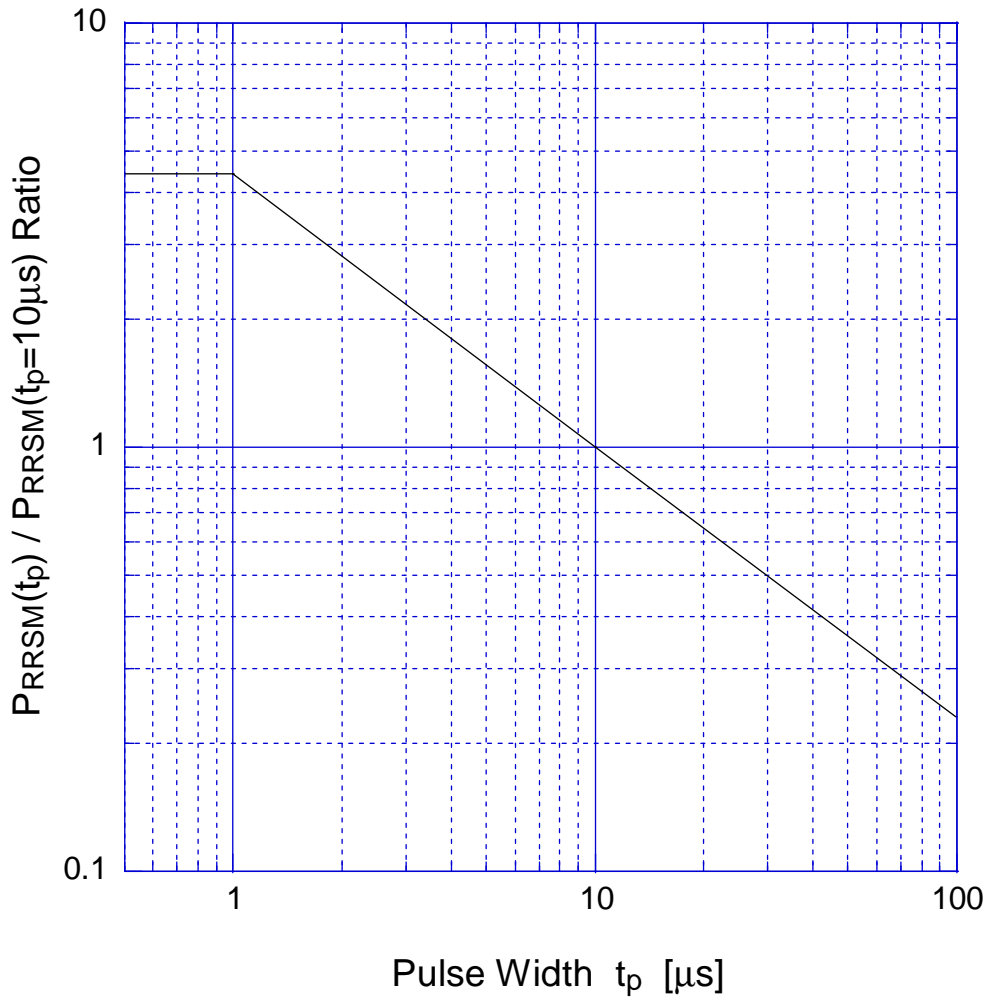

SF15SC4 Repetitive Surge Reverse Power Derating Curve

