

SHINDENGEN

Super Fast Recovery Rectifiers

Single

SF5L60

600V 5A

FEATURES

- High voltage trr50ns
- Fully Isolated Molding
- Dielectric strength 2kV guaranteed

APPLICATION

- PFC
- Switching power supply
- Free Wheel
- CTV+B output, lighting

OUTLINE DIMENSIONS

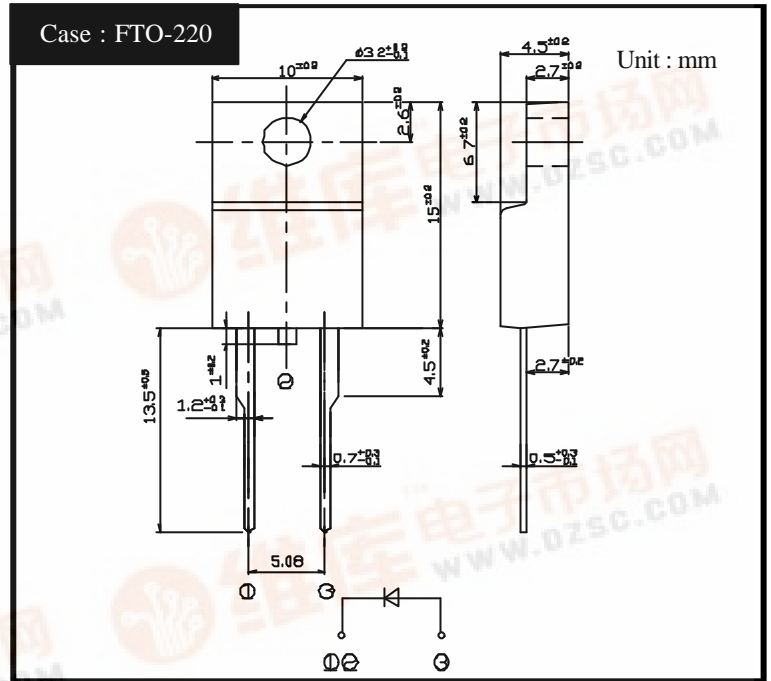

RATINGS

Absolute Maximum Ratings (If not specified Tc=25)

Item	Symbol	Conditions	Ratings	Unit
Storage Temperature	Tstg		-55 ~ 150	
Operating Junction Temperature	Tj		150	
Maximum Reverse Voltage	V _{RM}		600	V
Average Rectified Forward Current	I _O	50Hz sine wave, R-load, Tc=131	5	A
Peak Surge Forward Current	I _{FSM}	50Hz sine wave, Non-repetitive 1 cycle peak value, Tj=25	100	A
Dielectric Strength	V _{dis}	Terminals to case, AC 1 minute	2	kV
Mounting Torque	TOR	(Recommended torque 0.3N·m)	0.5	N·m

Electrical Characteristics (If not specified Tc=25)

Item	Symbol	Conditions	Ratings	Unit
Forward Voltage	V _F	I _F =5A, Pulse measurement	Max.1.5	V
Reverse Current	I _R	V _R =V _{RM} , Pulse measurement	Max.10	μA
Reverse Recovery Time	trr	I _F =0.5A, I _R =1A	Max.50	ns
Thermal Resistance	jc	junction to case	Max.2.5	/W



SF5L60

Forward Voltage

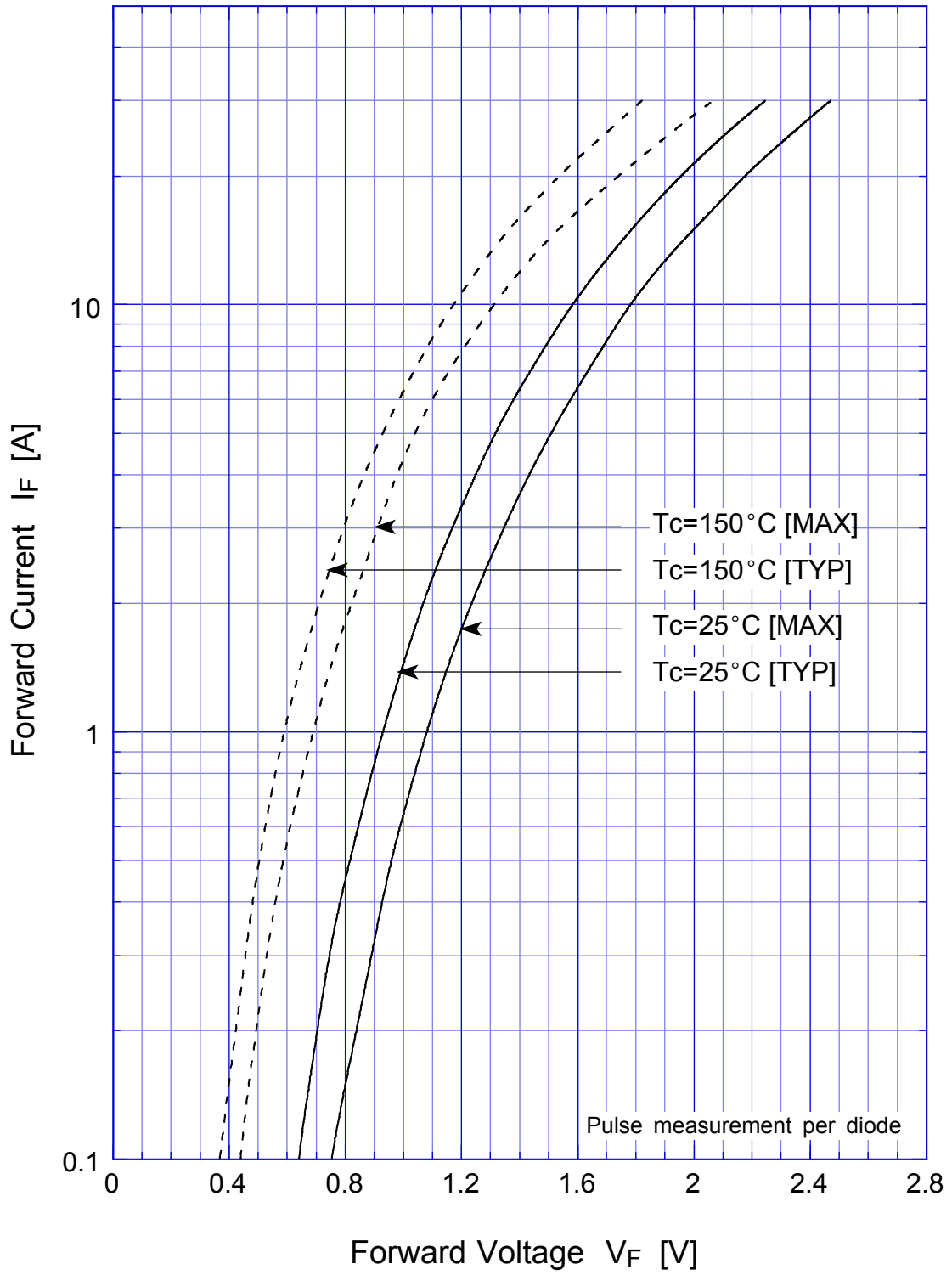

SF5L60

Forward Power Dissipation

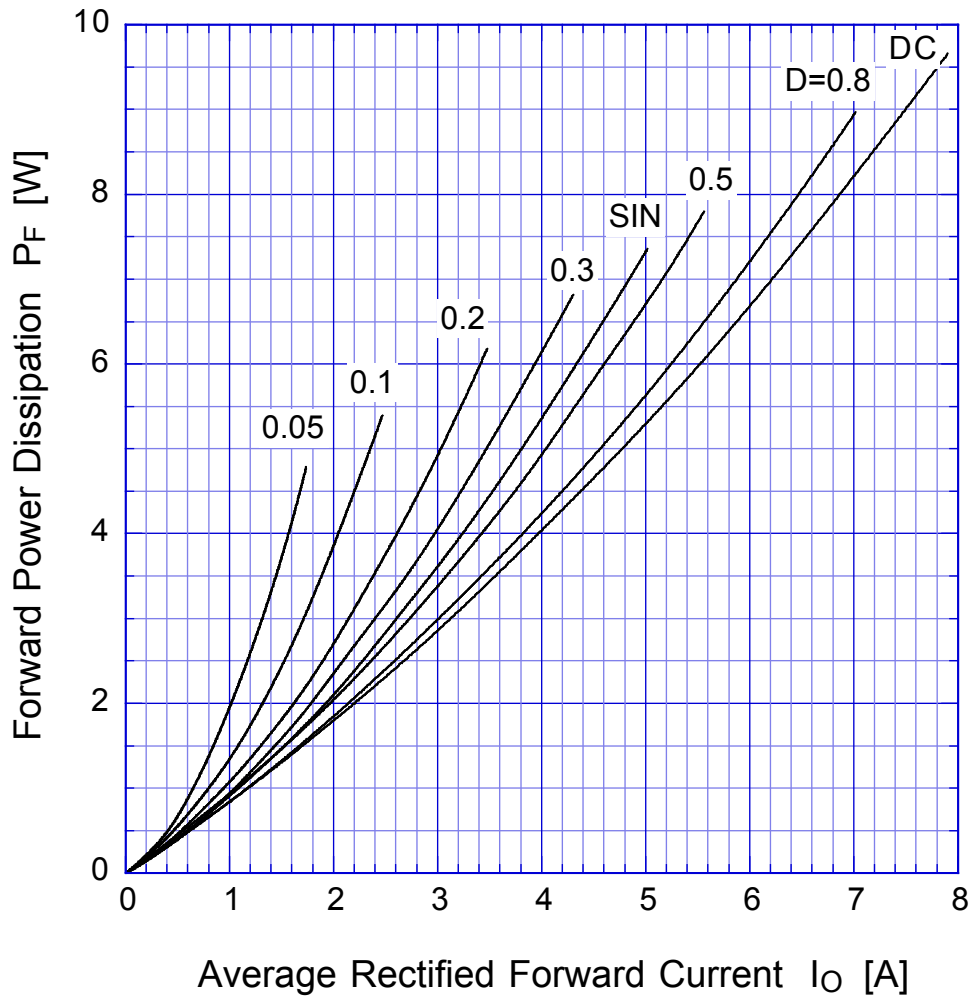

$T_j = T_{jmax}$

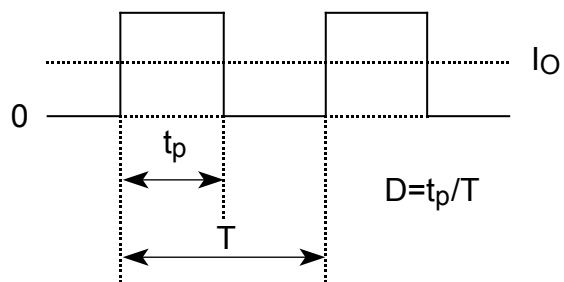

SF5L60

Derating Curve

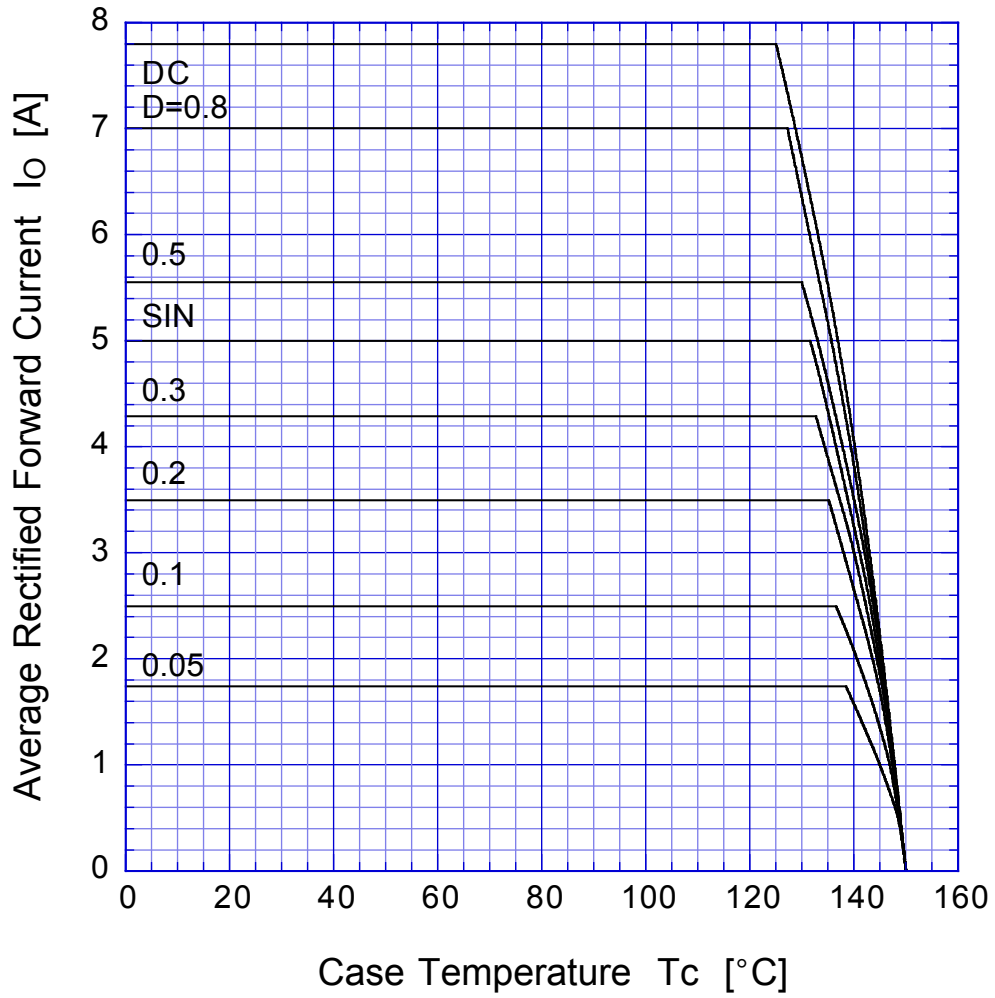

$$V_R = V_{RM}$$

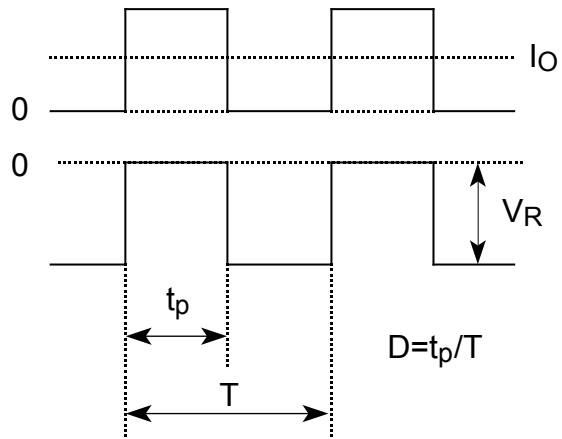

SF5L60

Peak Surge Forward Capability

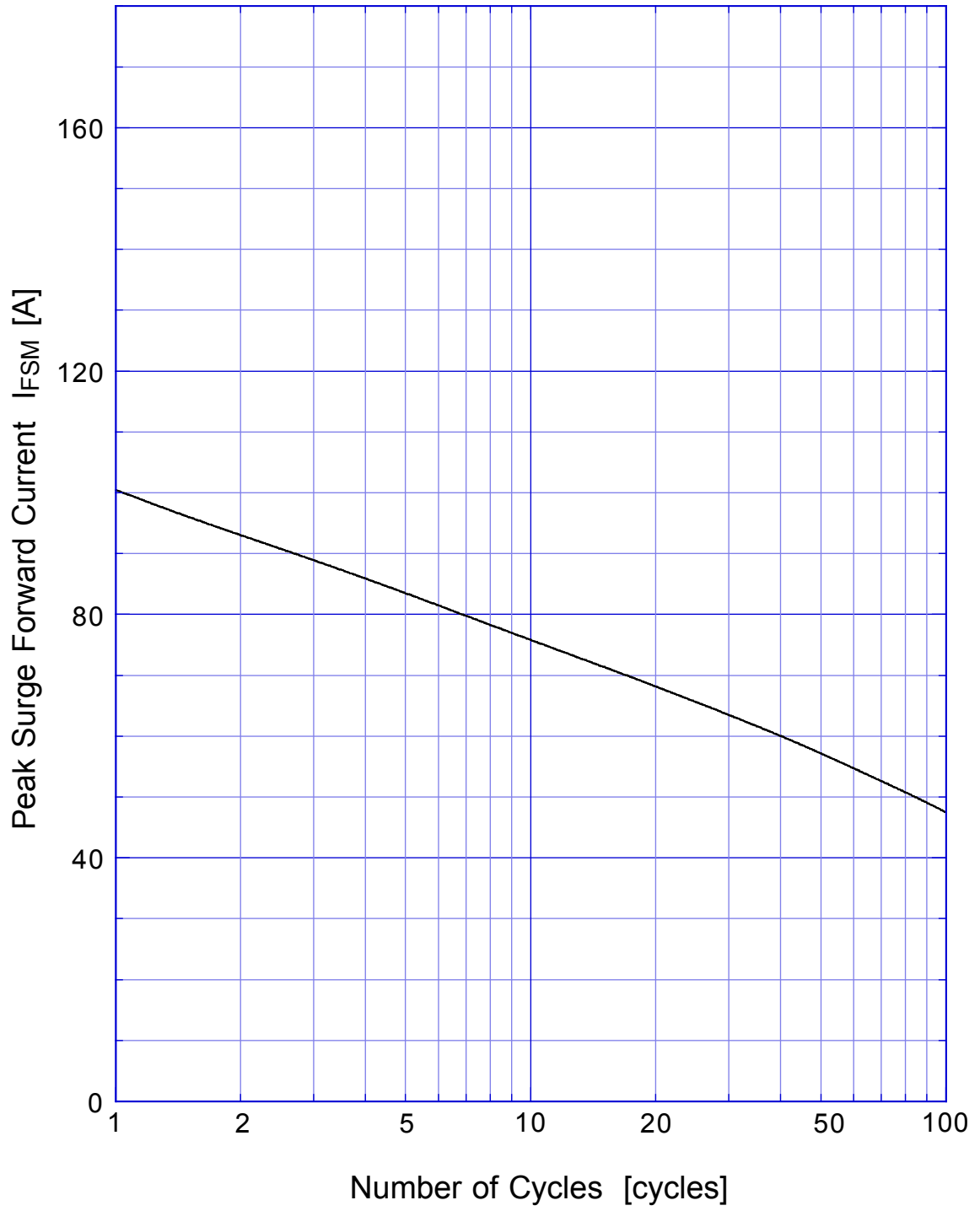

SF5L60 Junction Capacitance

