



SFC05-5

FLIP CHIP ARRAY

APPLICATIONS

- ✓ Cellular Phones
- ✓ Personal Digital Assistant (PDA)
- ✓ Ground Positioning System (GPS)
- ✓ SMART & PCMCIA Cards

IEC COMPATIBILITY (EN61000-4)

- ✓ 61000-4-2 (ESD): Air - 15kV, Contact - 8kV
- ✓ 61000-4-4 (EFT): 40A - 5/50ns
- ✓ 61000-4-5 (Surge): 24A, 8/20μs - Level 2(Line-Gnd) & Level 3(Line-Line)

FEATURES

- ✓ ESD Protection > 25 kilovolts
- ✓ 250 Watts Peak Pulse Power per Line (tp = 8/20μs)
- ✓ Protects up to Five(5) Unidirectional & Four (4) Bidirectional Lines

MECHANICAL CHARACTERISTICS

- ✓ Weight 0.73 milligrams (Approximate)
- ✓ Flammability Rating UL 94V-0
- ✓ 8mm Plastic & Paper Tape and Reel Per EIA Standard 481
- ✓ Device Marking On Reel
- ✓ Top Contacts: Solder Bump 0.004" in Height (Nominal)

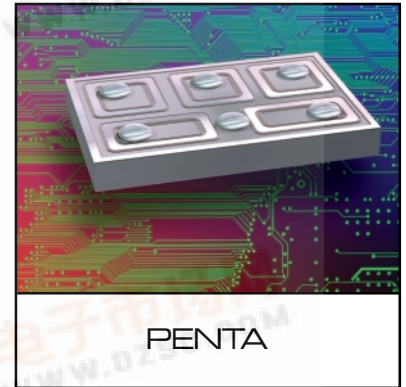

PIN CONFIGURATION

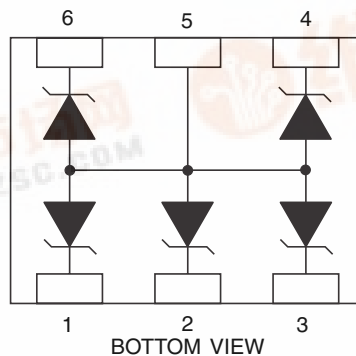

DEVICE CHARACTERISTICS

MAXIMUM RATINGS @ 25°C Unless Otherwise Specified			
PARAMETER	SYMBOL	VALUE	UNITS
Peak Pulse Power ($t_p = 8/20\mu s$) - See Figure 1	P_{PP}	250	Watts
Operating Temperature	T_J	-55°C to 150°C	°C
Storage Temperature	T_{STG}	-55°C to 150°C	°C

ELECTRICAL CHARACTERISTICS PER LINE @ 25°C Unless Otherwise Specified						
PART NUMBER	RATED STAND-OFF VOLTAGE	MINIMUM BREAKDOWN VOLTAGE	MAXIMUM CLAMPING VOLTAGE (See Fig. 2)	MAXIMUM CLAMPING VOLTAGE (See Fig. 2)	MAXIMUM LEAKAGE CURRENT	TYPICAL CAPACITANCE
	V_{WM} VOLTS	@ 1mA $V_{(BR)}$ VOLTS	@ $I_P = 5A$ V_C VOLTS	@ 8/20 μs $V_C @ I_{PP}$	@ V_{WM} I_D μA	@ 0V, 1 MHz C_j pF
SFC05-5	5.0	6.0	9.5	11.0V @ 24A	10	150

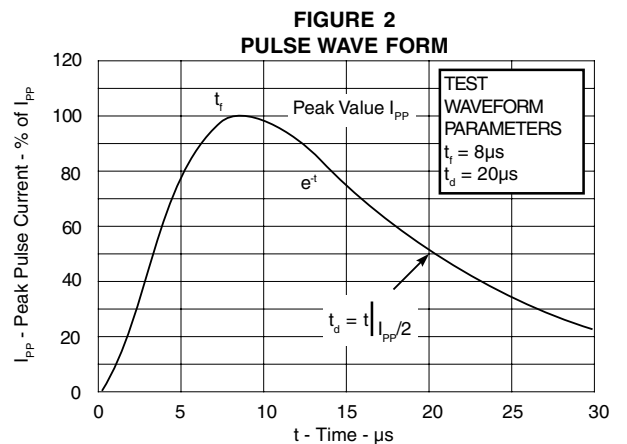
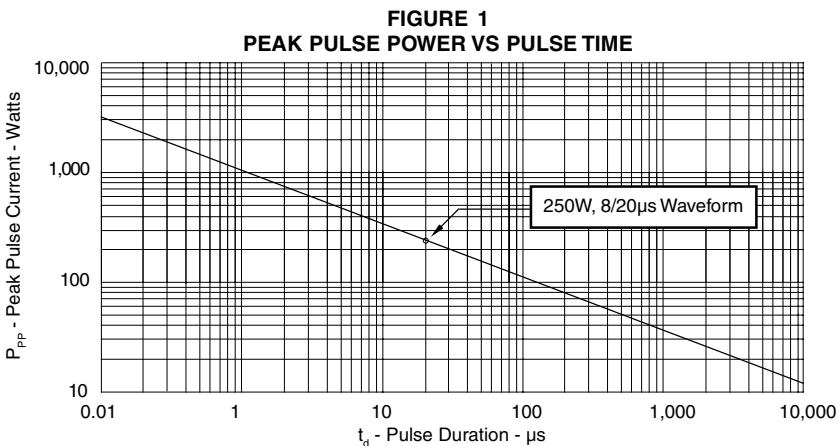

GRAPHS

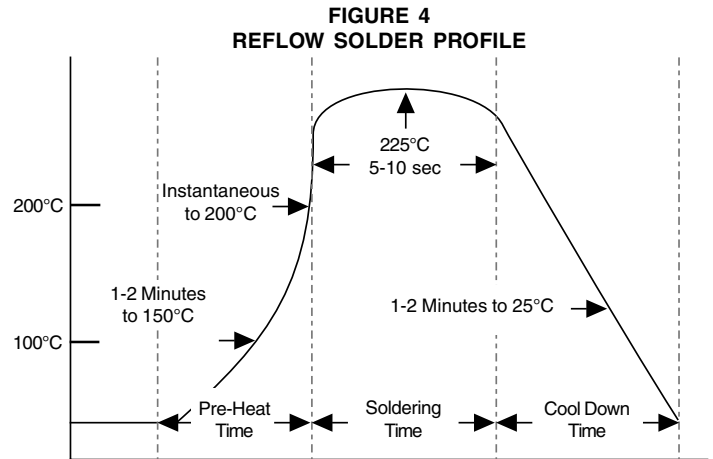
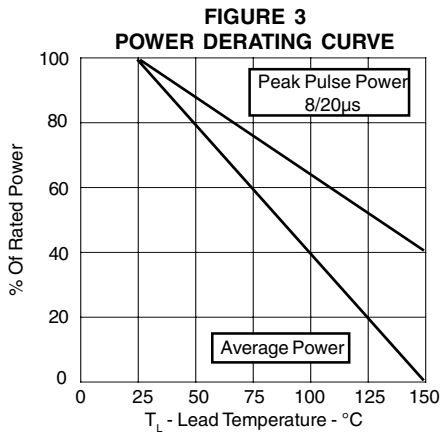

Note: This reflow profile does not take into account the printed circuit board (PCB) material heating time. Additional time may be required for the preheat time and cool down time upon the PCB or board material.

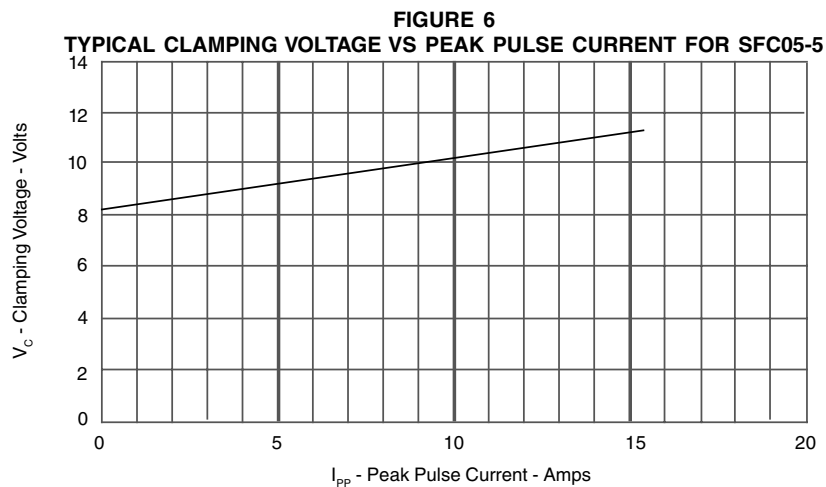
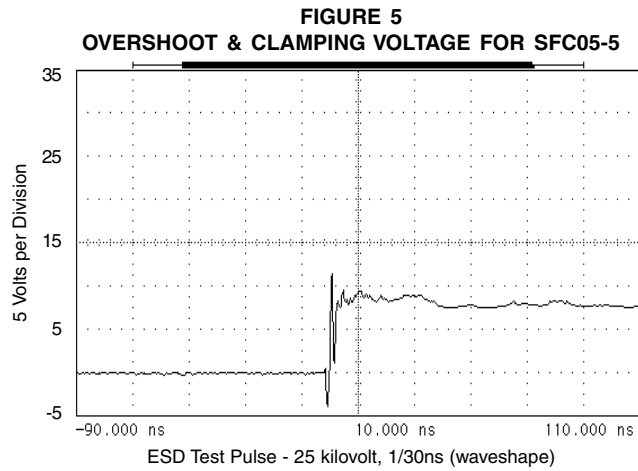

PACKAGE OUTLINE & DIMENSIONS

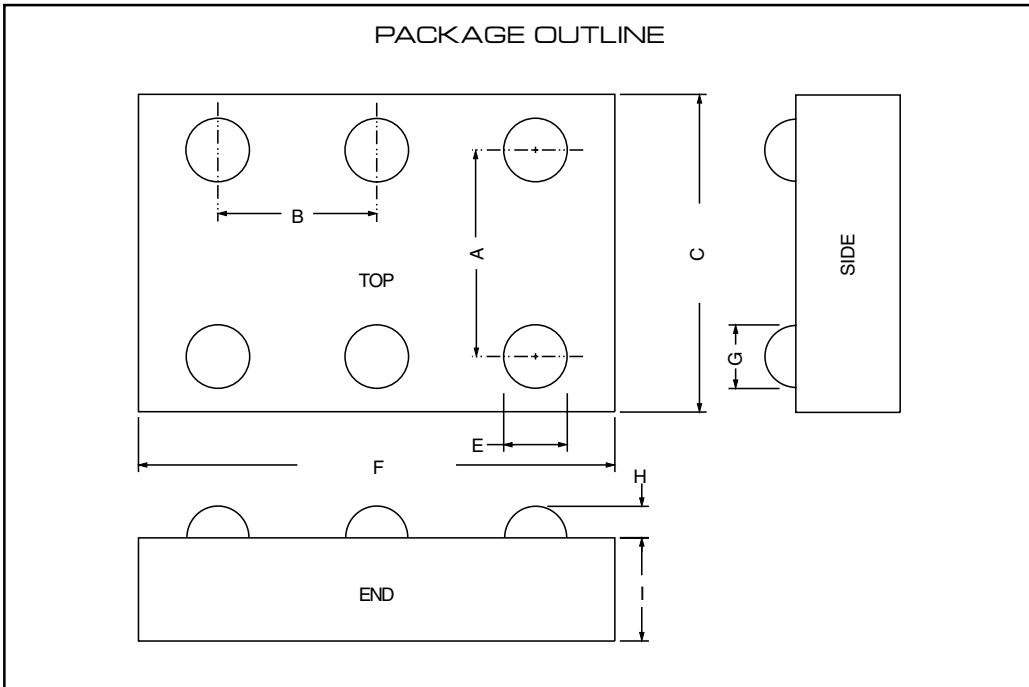

PACKAGE DIMENSIONS

DIM	MILLIMETERS	INCHES
A	0.510	0.020
B	0.510	0.020
C	0.99 ± 0.0254	0.039 ± 0.001
E	0.15 NOM	0.006 NOM
F	1.5 ± 0.0254	0.059 ± 0.001
G	0.15 NOM	0.006 NOM
H	See Note 3	See Note 3
	0.076 MIN	0.003 MIN
I	0.419 NOM	0.0165 NOM

NOTES:

- Controlling dimensions in inches.
- Decimal tolerances for mounting pad and outline: .xxx ± 0.05mm (± 0.002").
- "H" Dimensions for the SFC05-5 device are 0.10mm Max and 0.004" Max.

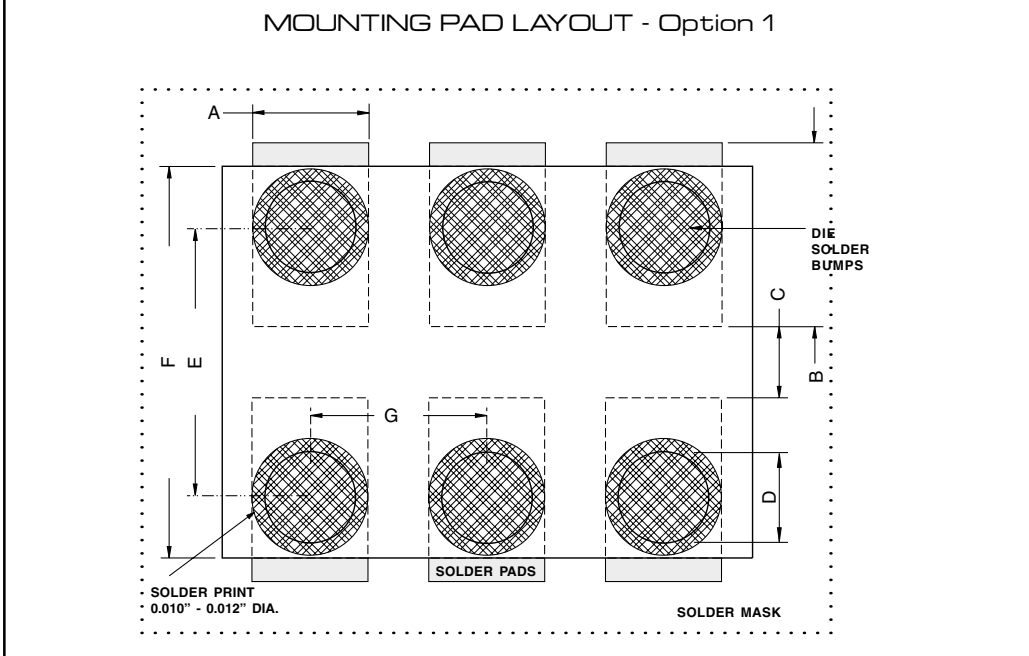

PAD DIMENSIONS

DIM	MILLIMETERS	INCHES
A	0.305	0.012
B	0.457	0.018
C	0.203	0.008
D	0.254	0.010
E	0.510	0.020
F	0.990	0.039
G	0.510	0.020

NOTE:

- Preferred: Using 0.1mm (0.004") stencil.

Outline & Dimensions: Rev 1 - 1/03, 06038

PACKAGE OUTLINE & DIMENSIONS

MOUNTING PAD LAYOUT - Option 2

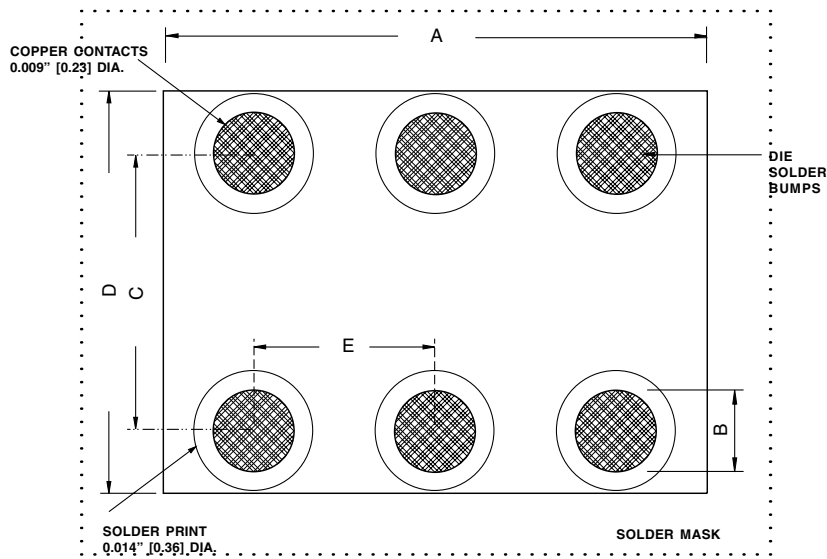

PACKAGE DIMENSIONS

DIM	MILLIMETERS	INCHES
A	1.5 NOM	0.059
B	0.152 NOM	0.006 NOM
C	0.510	0.020
D	0.990	0.039
E	0.510	0.020

NOTES:

1. Controlling dimensions in inches.
2. Decimal tolerances for mounting pad and outline: .xxx ± 0.05mm (± 0.002").
3. Preferred: Using 0.1mm (0.004") stencil.

Outline & Dimensions: Rev 0 - 10/02, 06039

TAPE & REEL ORIENTATION

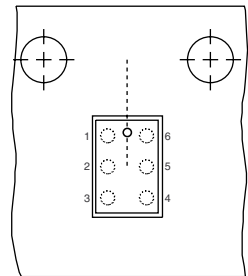

NOTE:

1. Top view of tape. Solder bumps are face down in tape package.

TAPE & REEL ORDERING NOMENCLATURE

1. Surface mount product is taped and reeled in accordance with EIA 481.
2. 8mm Plastic Tape: 7 Inch Reels - 5,000 pieces per reel. Ordering Suffix: -T75-1 (i.e., SFC05-5-T75-1).
3. 8mm Paper Tape: 7 Inch Reels - 5,000 pieces per reel. Ordering Suffix: -T75-2 (i.e., SFC05-5-T75-2).

COPYRIGHT © ProTek Devices 2003

SPECIFICATIONS: ProTek reserves the right to change the electrical and or mechanical characteristics described herein without notice (except JEDEC).

DESIGN CHANGES: ProTek reserves the right to discontinue product lines without notice, and that the final judgement concerning selection and specifications is the buyer's and that in furnishing engineering and technical assistance, ProTek assumes no responsibility with respect to the selection or specifications of such products.

ProTek Devices

2929 South Fair Lane, Tempe, AZ 85282

Tel: 602-431-8101 Fax: 602-431-2288

E-Mail: sales@protekdevices.com

Web Site: www.protekdevices.com