

Advanced Power MOSFET

SFW/I9540

FEATURES

- Avalanche Rugged Technology
- Rugged Gate Oxide Technology
- Lower Input Capacitance
- Improved Gate Charge
- Extended Safe Operating Area
- 175°C Operating Temperature
- Lower Leakage Current : 10 μA (Max.) @ $V_{DS} = -100V$
- Low $R_{DS(ON)}$: 0.161 Ω (Typ.)

$$BV_{DSS} = -100 V$$

$$R_{DS(on)} = 0.2 \Omega$$

$$I_D = -17 A$$

D²-PAK I²-PAK

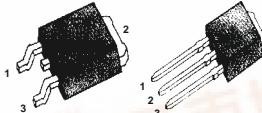

1. Gate 2. Drain 3. Source

Absolute Maximum Ratings

| Symbol | Characteristic | Value | Units |
|----------------|---|--------------|-------|
| V_{DSS} | Drain-to-Source Voltage | -100 | V |
| I_D | Continuous Drain Current ($T_C=25^\circ C$) | -17 | A |
| | Continuous Drain Current ($T_C=100^\circ C$) | -12 | |
| I_{DM} | Drain Current-Pulsed ① | -68 | A |
| V_{GS} | Gate-to-Source Voltage | ±30 | V |
| E_{AS} | Single Pulsed Avalanche Energy ② | 578 | mJ |
| I_{AR} | Avalanche Current ① | -17 | A |
| E_{AR} | Repetitive Avalanche Energy ① | 13.2 | mJ |
| dv/dt | Peak Diode Recovery dv/dt ③ | -6.5 | V/ns |
| P_D | Total Power Dissipation ($T_A=25^\circ C$) * | 3.8 | W |
| | Total Power Dissipation ($T_C=25^\circ C$) | 132 | W |
| | Linear Derating Factor | 0.88 | W/°C |
| T_J, T_{STG} | Operating Junction and Storage Temperature Range | - 55 to +175 | °C |
| T_L | Maximum Lead Temp. for Soldering Purposes, 1/8" from case for 5-seconds | 300 | |

Thermal Resistance

| Symbol | Characteristic | Typ. | Max. | Units |
|-----------------|-----------------------|------|------|-------|
| $R_{\theta JC}$ | Junction-to-Case | -- | 1.14 | °C/W |
| $R_{\theta JA}$ | Junction-to-Ambient * | -- | 40 | |
| $R_{\theta JA}$ | Junction-to-Ambient | -- | 62.5 | |

* When mounted on the minimum pad size recommended (PCB Mount).

FAIRCHILD
SEMICONDUCTOR®

Rev. C

Electrical Characteristics ($T_C=25^\circ\text{C}$ unless otherwise specified)

| Symbol | Characteristic | Min. | Typ. | Max. | Units | Test Condition |
|------------------------|---|------|-------|------|---------------------|---|
| BV_{DSS} | Drain-Source Breakdown Voltage | -100 | -- | -- | V | $V_{GS}=0V, I_D=-250\mu A$ |
| $\Delta BV/\Delta T_J$ | Breakdown Voltage Temp. Coeff. | -- | -0.11 | -- | V/ $^\circ\text{C}$ | $I_D=-250\mu A$ See Fig 7 |
| $V_{GS(th)}$ | Gate Threshold Voltage | -2.0 | -- | -4.0 | V | $V_{DS}=-5V, I_D=-250\mu A$ |
| I_{GSS} | Gate-Source Leakage, Forward | -- | -- | -100 | nA | $V_{GS}=-20V$ |
| | Gate-Source Leakage, Reverse | -- | -- | 100 | | $V_{GS}=20V$ |
| I_{DSS} | Drain-to-Source Leakage Current | -- | -- | -10 | μA | $V_{DS}=-100V$ |
| | | -- | -- | -100 | | $V_{DS}=-80V, T_C=150^\circ\text{C}$ |
| $R_{DS(on)}$ | Static Drain-Source On-State Resistance | -- | -- | 0.2 | Ω | $V_{GS}=-10V, I_D=-8.5A$ ④ |
| g_{fs} | Forward Transconductance | -- | 9.5 | -- | S | $V_{DS}=-40V, I_D=-8.5A$ ④ |
| C_{iss} | Input Capacitance | -- | 1180 | 1535 | pF | $V_{GS}=0V, V_{DS}=-25V, f=1\text{MHz}$ See Fig 5 |
| C_{oss} | Output Capacitance | -- | 240 | 360 | | |
| C_{rss} | Reverse Transfer Capacitance | -- | 83 | 125 | | |
| $t_{d(on)}$ | Turn-On Delay Time | -- | 14 | 40 | ns | $V_{DD}=-50V, I_D=-17A,$ $R_G=12\Omega$ See Fig 13 ④⑤ |
| t_r | Rise Time | -- | 22 | 55 | | |
| $t_{d(off)}$ | Turn-Off Delay Time | -- | 45 | 100 | | |
| t_f | Fall Time | -- | 26 | 60 | | |
| Q_g | Total Gate Charge | -- | 43 | 54 | nC | $V_{DS}=-80V, V_{GS}=-10V,$ $I_D=-17A$ See Fig 6 & Fig 12 ④⑤ |
| Q_{gs} | Gate-Source Charge | -- | 7.4 | -- | | |
| Q_{gd} | Gate-Drain("Miller") Charge | -- | 17.8 | -- | | |

Source-Drain Diode Ratings and Characteristics

| Symbol | Characteristic | Min. | Typ. | Max. | Units | Test Condition |
|----------|---------------------------|------|------|------|---------------|---|
| I_S | Continuous Source Current | -- | -- | -17 | A | Integral reverse pn-diode in the MOSFET |
| I_{SM} | Pulsed-Source Current ① | -- | -- | -68 | | |
| V_{SD} | Diode Forward Voltage ④ | -- | -- | -4.0 | V | $T_J=25^\circ\text{C}, I_S=-17A, V_{GS}=0V$ |
| t_{rr} | Reverse Recovery Time | -- | 135 | -- | ns | $T_J=25^\circ\text{C}, I_F=-17A$ |
| Q_{rr} | Reverse Recovery Charge | -- | 0.7 | -- | μC | $di_F/dt=100A/\mu\text{s}$ ④ |

Notes :

- ① Repetitive Rating : Pulse Width Limited by Maximum Junction Temperature
- ② $L=3.0\text{mH}, I_{AS}=-17A, V_{DD}=-25V, R_G=27\Omega^*$, Starting $T_J=25^\circ\text{C}$
- ③ $I_{SD} \leq -17A, di/dt \leq 450A/\mu\text{s}, V_{DD} \leq BV_{DSS}$, Starting $T_J=25^\circ\text{C}$
- ④ Pulse Test : Pulse Width = 250 μs , Duty Cycle $\leq 2\%$
- ⑤ Essentially Independent of Operating Temperature

Fig 1. Output Characteristics

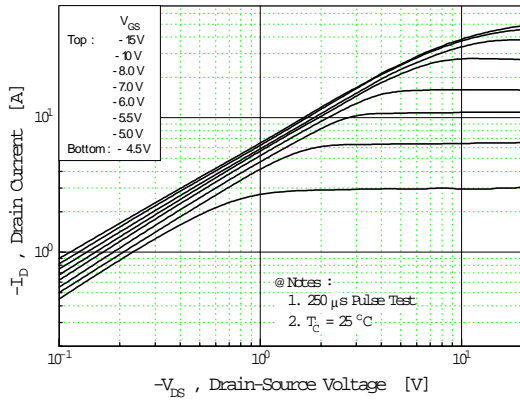

Fig 2. Transfer Characteristics

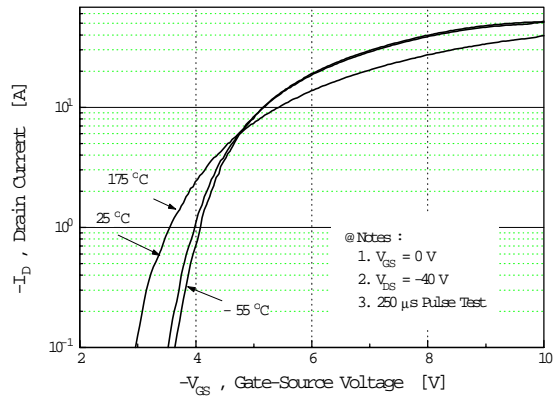

Fig 3. On-Resistance vs. Drain Current

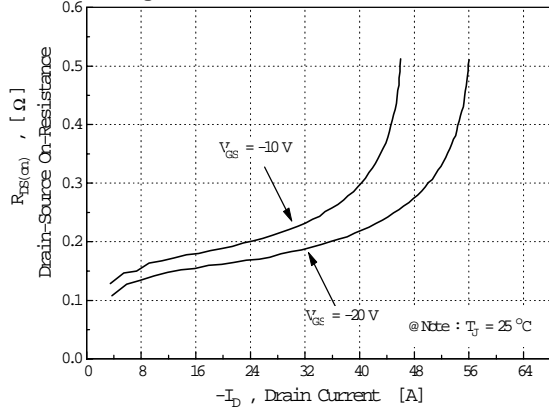

Fig 4. Source-Drain Diode Forward Voltage

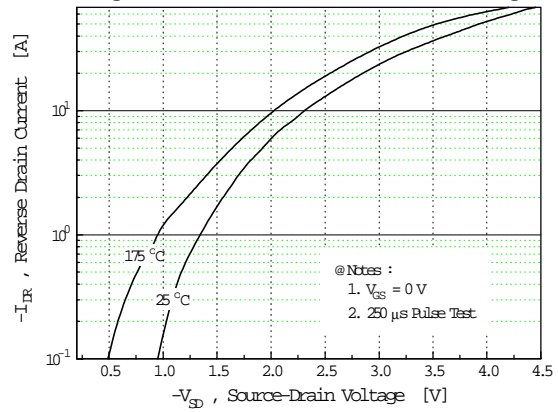

Fig 5. Capacitance vs. Drain-Source Voltage

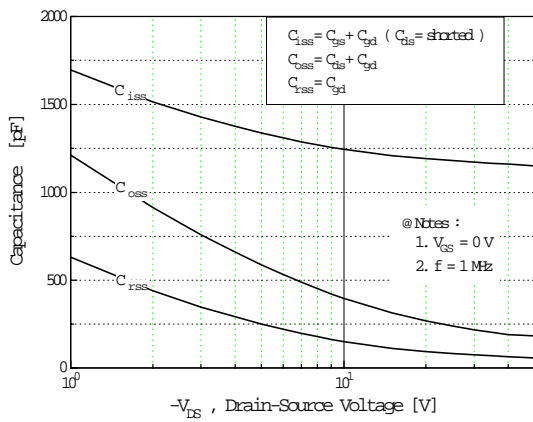

Fig 6. Gate Charge vs. Gate-Source Voltage

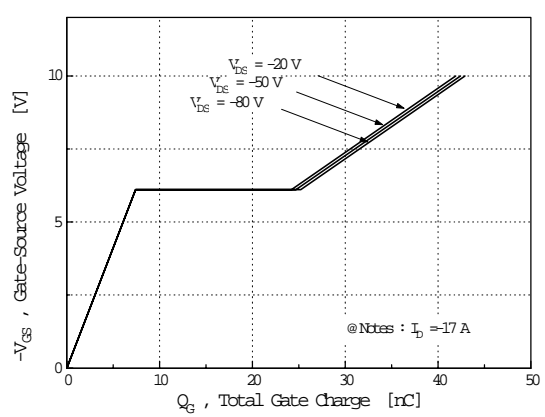

Fig 7. Breakdown Voltage vs. Temperature

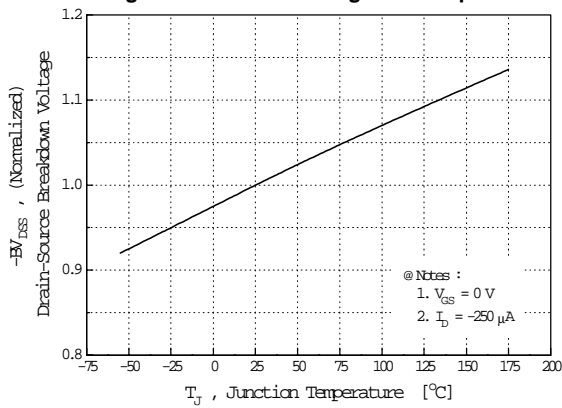

Fig 8. On-Resistance vs. Temperature

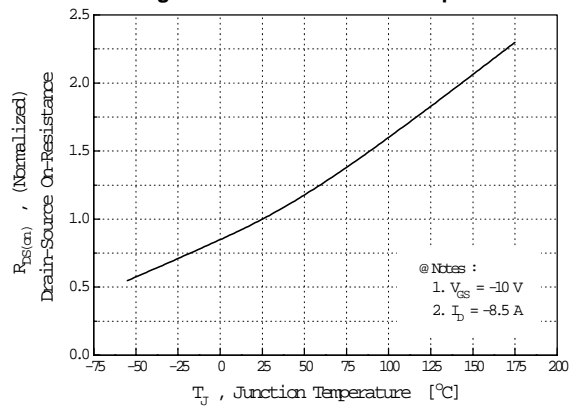

Fig 9. Max. Safe Operating Area

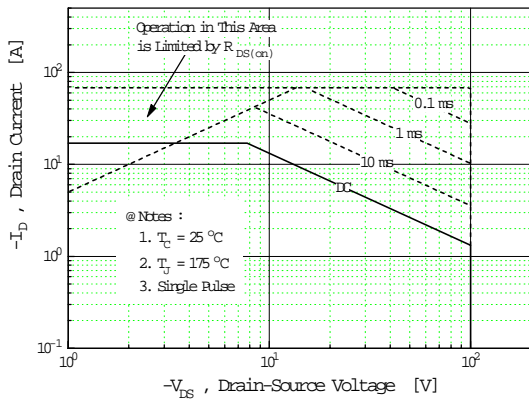

Fig 10. Max. Drain Current vs. Case Temperature

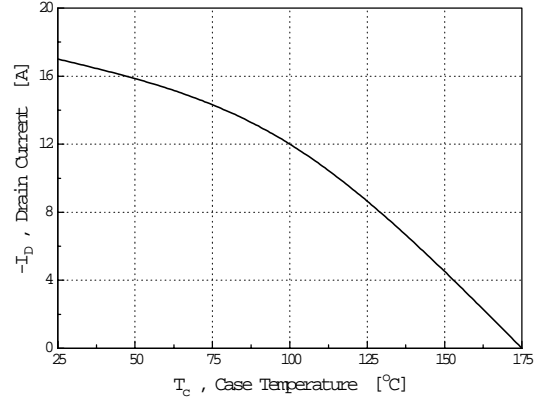

Fig 11. Thermal Response

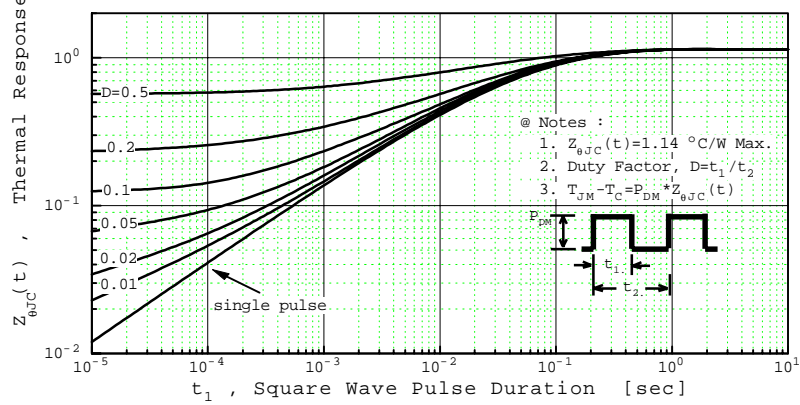

Fig 12. Gate Charge Test Circuit & Waveform

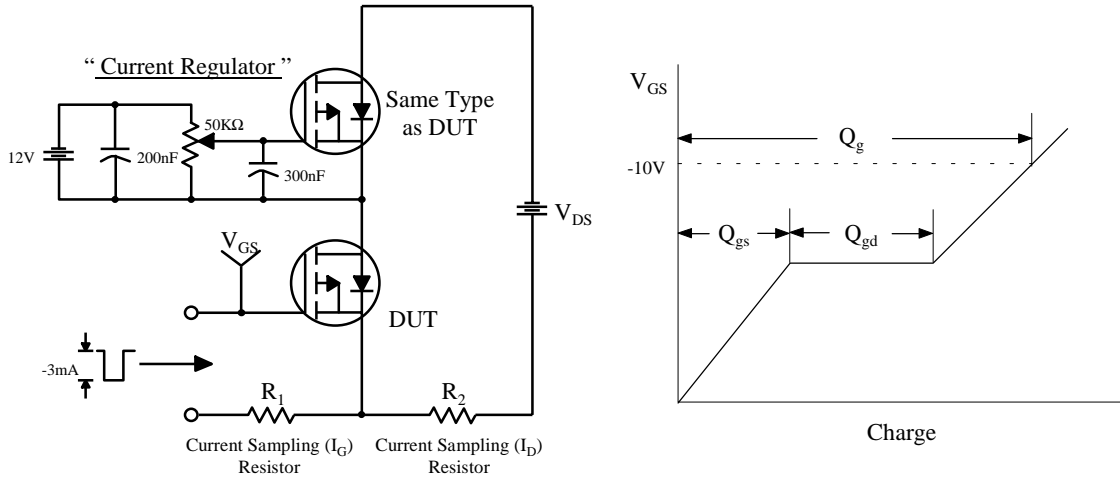

Fig 13. Resistive Switching Test Circuit & Waveforms

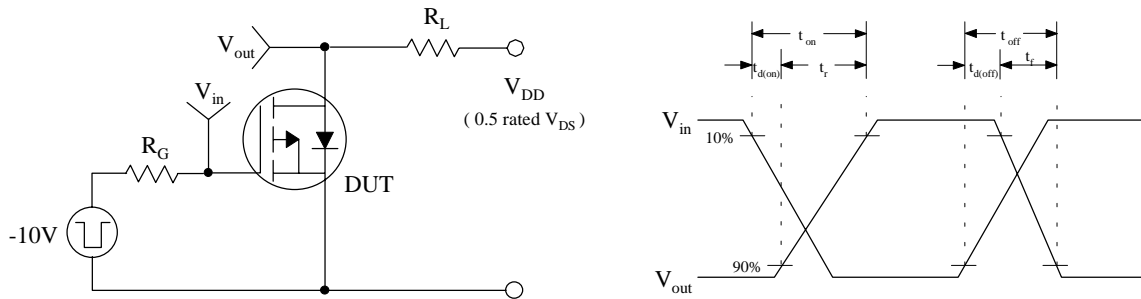

Fig 14. Unclamped Inductive Switching Test Circuit & Waveforms

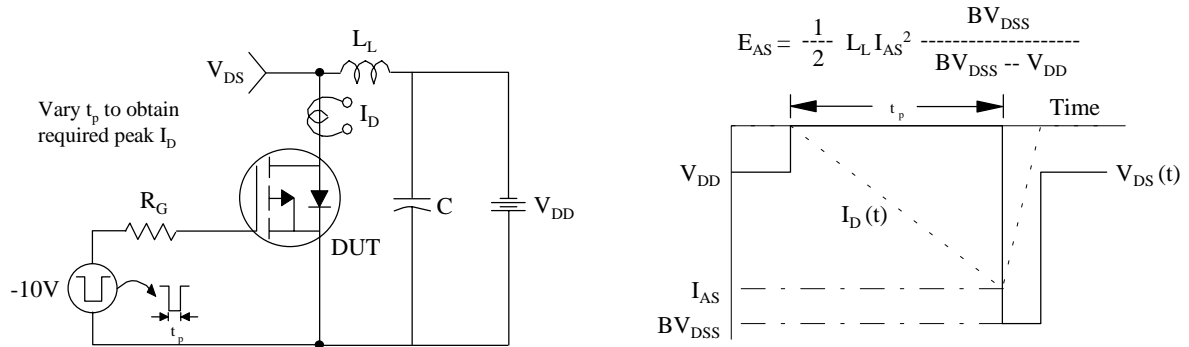

Fig 15. Peak Diode Recovery dv/dt Test Circuit & Waveforms

