

Photointerrupters(Reflective)

KODENSHI

SG - 113

The SG - 113 reflective sensor for paper sensing combine high - output GaAs IRED with high sensitivity phototransistor.It is most applicable to paper sensor.

FEATURES

- Long focal distance type
- Adopted the three pins connector

APPLICATIONS

- Copiers
- Printers
- Facsimiles

DIMENSIONS

(Unit : mm)

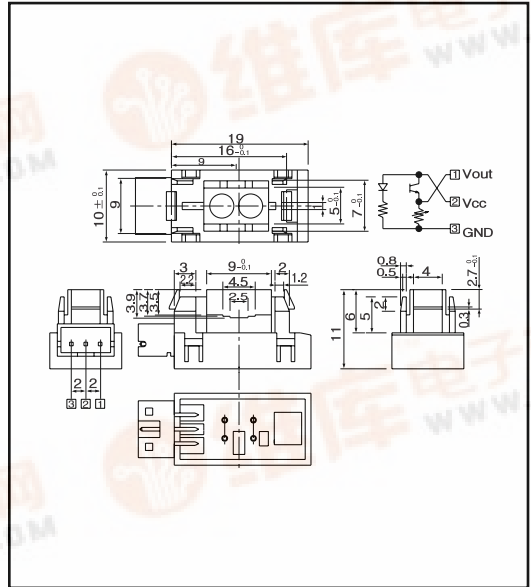

MAXIMUM RATINGS

(Ta=25 )

Item	Symbol	Rating	Unit
Supply voltage	V <sub>cc</sub>	7	V
Output consumption	I <sub>o</sub>	1	mA
Operating temp.	T <sub>opr.</sub>	- 10 +70	
Storage temp.	T <sub>stg.</sub>	- 20 +80	

ELECTRO-OPTICAL CHARACTERISTICS

(Ta=25 )

Item	Symbol	Conditions	Min.	Typ.	Max.	Unit.
Supply voltage	V <sub>cc</sub>		4.5	5.0	5.5	V
High level output voltage	V <sub>OH</sub>	d=5mm	2.1	3.0	3.9	V
Low level output voltage	V <sub>OL</sub>	d=5mm		0.6	0.8	V
Frequency	f				170	Hz
Current consumption	I <sub>cc</sub>	d=5mm		1.8	35	mA

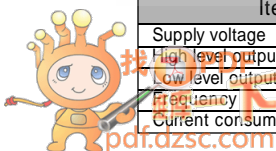

**Photo interrupters(Reflective)**

**SG - 113**

**Relative output voltage Vs. Ambient temperature**

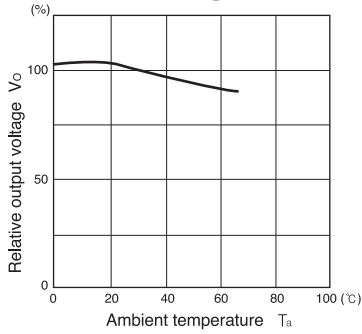

**Relative output voltage Vs. Distance between device and reflector**

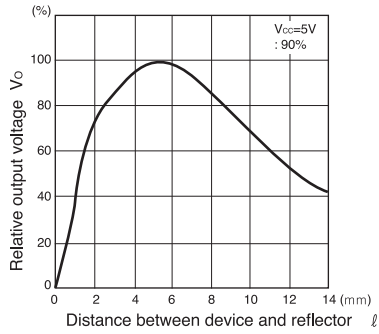

**Relative output voltage Vs. Moving distance**

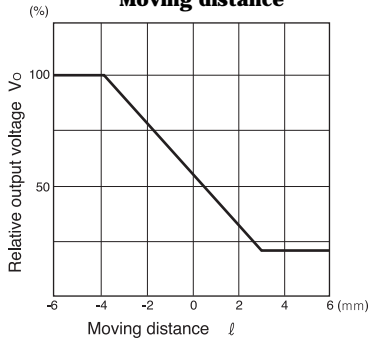

**Relative output voltage Vs. Moving distance**

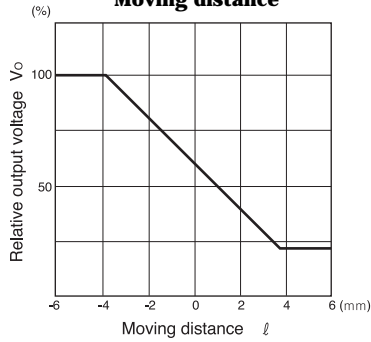

Method of measuring position detec characteristic (X)

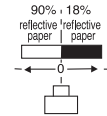

Method of measuring position detec characteristic (Y)

