

Product Description

Stanford Microdevices' SGA-3363 is a high performance SiGe Heterojunction Bipolar Transistor MMIC Amplifier. A Darlington configuration featuring 1 micron emitters provides high F_T and excellent thermal performance. The heterojunction increases breakdown voltage and minimizes leakage current between junctions. Cancellation of emitter junction non-linearities results in higher suppression of intermodulation products. At 850 MHz and 35mA, the SGA-3363 typically provides +25.4 dBm output IP₃, 17.3 dB of gain, and +11.6 dBm of 1dB compressed power using a single positive voltage supply. Only 2 DC-blocking capacitors, a bias resistor and an optional RF choke are required for operation.

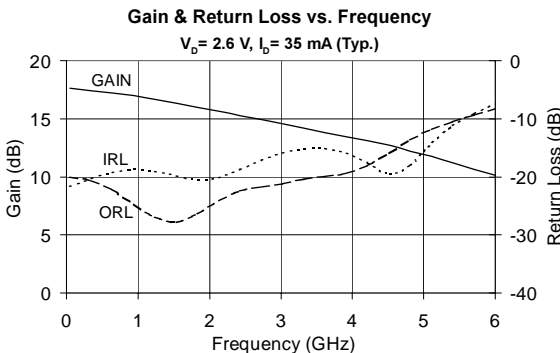

SGA-3363

DC-5500 MHz, Cascadable SiGe HBT MMIC Amplifier



Product Features

- High Gain : 15.9 dB at 1950 MHz
- Cascadable 50 Ohm
- Patented SiGe Technology
- Operates From Single Supply
- Low Thermal Resistance Package

Applications

- Cellular, PCS, CDPD
- Wireless Data, SONET
- Satellite

Symbol	Parameter	Units	Frequency	Min.	Typ.	Max.
G	Small Signal Gain	dB	850 MHz	15.6	17.3	19.8
		dB	1950 MHz		15.9	
		dB	2400 MHz		15.3	
P _{1dB}	Output Power at 1dB Compression	dBm	850 MHz		11.6	
		dBm	1950 MHz		10.5	
OIP ₃	Output Third Order Intercept Point (Power out per tone = -5dBm)	dBm	850 MHz		25.4	
		dBm	1950 MHz		23.1	
Bandwidth	Determined by Return Loss (<-10dB)	MHz			5500	
IRL	Input Return Loss	dB	1950 MHz		20.4	
ORL	Output Return Loss	dB	1950 MHz		25.5	
NF	Noise Figure	dB	1950 MHz		3.3	
V _D	Device Voltage	V		2.3	2.6	2.9
R _{Th}	Thermal Resistance	°C/W			255	

Test Conditions: $V_S = 5\text{ V}$ $I_D = 35\text{ mA Typ.}$ OIP_3 Tone Spacing = 1 MHz, Pout per tone = -5 dBm
 $R_{BIAS} = 68\text{ Ohms}$ $T_L = 25^\circ\text{C}$ $Z_S = Z_L = 50\text{ Ohms}$

The information provided herein is believed to be reliable at press time. Stanford Microdevices assumes no responsibility for inaccuracies or omissions. Stanford Microdevices assumes no responsibility for the use of this information, and all such information shall be entirely at the user's own risk. Prices and specifications are subject to change without notice. No patent rights or licenses to any of the circuits described herein are implied or granted to any third party. Stanford Microdevices does not authorize or warrant any Stanford Microdevices product for use in life-support devices and/or systems. Copyright 2000 Stanford Microdevices, Inc. All worldwide rights reserved.

Typical RF Performance at Key Operating Frequencies

Symbol	Parameter	Unit	Frequency (MHz)					
			100	500	850	1950	2400	3500
G	Small Signal Gain	dB	17.6	17.3	17.3	15.9	15.3	14.0
OIP ₃	Output Third Order Intercept Point	dBm		26.0	25.4	23.1	21.3	
P _{1dB}	Output Power at 1dB Compression	dBm		11.5	11.6	10.5	9.4	
IRL	Input Return Loss	dB	21.3	19.7	18.8	20.4	18.8	15.1
ORL	Output Return Loss	dB	20.2	21.3	23.9	25.5	22.5	20.1
S ₁₂	Reverse Isolation	dB	20.7	20.7	20.8	21.0	20.8	20.1
NF	Noise Figure	dB		3.1	2.9	3.3	3.8	

Test Conditions: V_S = 5 V, I_D = 35 mA Typ., OIP₃ Tone Spacing = 1 MHz, P_{out} per tone = -5 dBm
R_{BIAS} = 68 Ohms, T_L = 25°C, Z_S = Z_L = 50 Ohms

Noise Figure vs. Frequency

V_D = 2.6 V, I_D = 35 mA (Typ.)

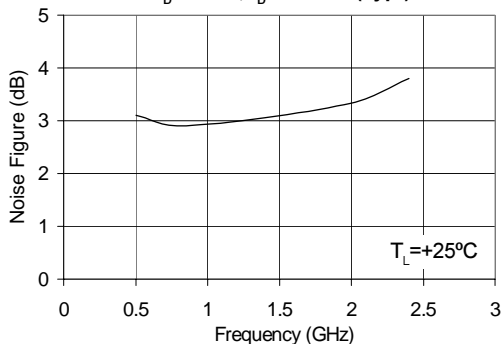

Absolute Maximum Ratings

Parameter	Absolute Limit
Max. Device Current (I _D)	70 mA
Max. Device Voltage (V _D)	4 V
Max. RF Input Power	+5 dBm
Max. Junction Temp. (T _J)	+150°C
Operating Temp. Range (T _L)	-40°C to +85°C
Max. Storage Temp.	+150°C

Operation of this device beyond any one of these limits may cause permanent damage.

Bias Conditions should also satisfy the following expression: I_D V_D (max) < (T_J - T_L)/R_{th}

OIP₃ vs. Frequency

V_D = 2.6 V, I_D = 35 mA (Typ.)

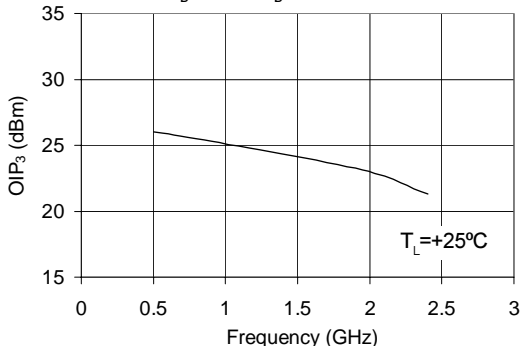

P_{1dB} vs. Frequency

V_D = 2.6 V, I_D = 35 mA (Typ.)

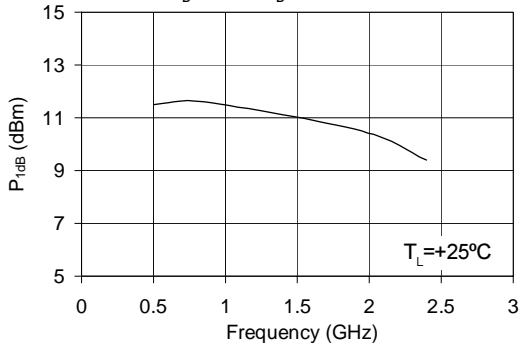

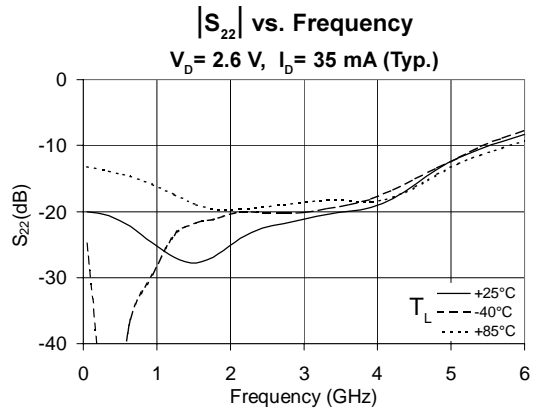
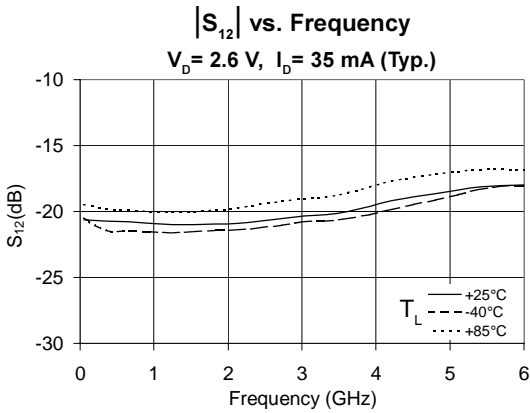
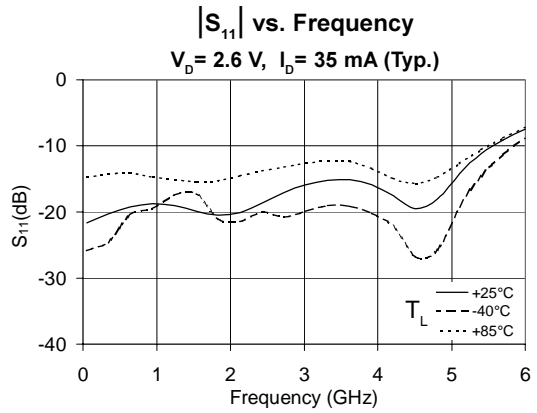
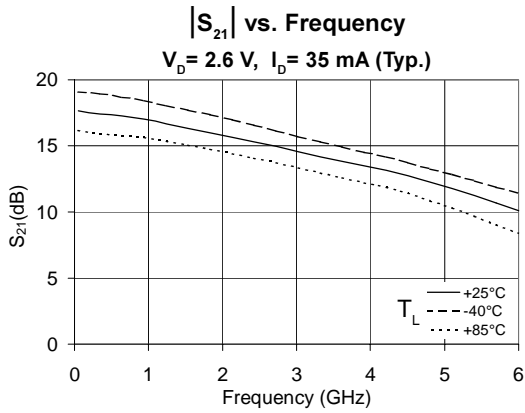

NOTE: Full S-parameter data available at www.stanfordmicro.com

Basic Application Circuit

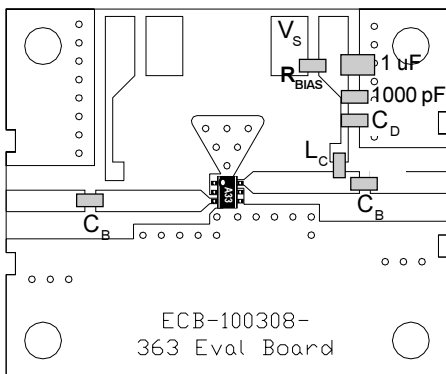
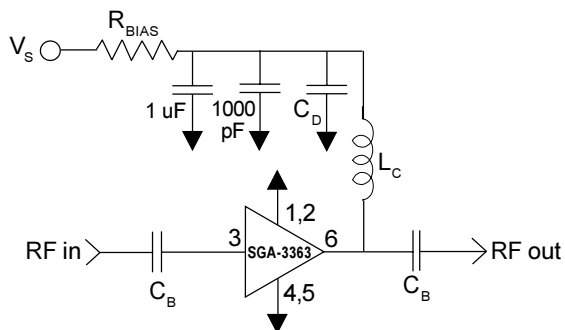

Part Identification Marking

The part will be marked with an "A33" designator on the top surface of the package.

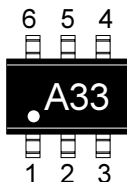

For package dimensions, refer to outline drawing at www.stanfordmicro.com



Caution: ESD sensitive

Appropriate precautions in handling, packaging and testing devices must be observed.

Application Circuit Element Values

Reference Designator	Frequency (Mhz)				
	500	850	1950	2400	3500
C _B	220 pF	100 pF	68 pF	56 pF	39 pF
C _D	100 pF	68 pF	22 pF	22 pF	15 pF
L _C	68 nH	33 nH	22 nH	18 nH	15 nH

Recommended Bias Resistor Values for I_D=35mA

Supply Voltage(V _S)	5 V	8 V	10 V	12 V
R _{BIAS}	68 Ω	150 Ω	200 Ω	270 Ω

Note: R_{BIAS} provides DC bias stability over temperature.

Mounting Instructions

- Use a large ground pad area near device pins 1, 2, 4, and 5 with many plated through-holes as shown.
-
- We recommend 1 or 2 ounce copper. Measurements for this data sheet were made on a 31 mil thick FR-4 board with 1 ounce copper on both sides.

Pin #	Function	Description
3	RF IN	RF input pin. This pin requires the use of an external DC blocking capacitor chosen for the frequency of operation.
1	GND	Connection to ground. Use via holes for best performance to reduce lead inductance as close to ground leads as possible.
6	RF OUT/BIAS	RF output and bias pin. DC voltage is present on this pin, therefore a DC blocking capacitor is necessary for proper operation.
2,4,5	GND	Sames as Pin 2

Part Number Ordering Information

Part Number	Reel Size	Devices/Reel
SGA-3363	7"	3000

Copyright © Each Manufacturing Company.

All Datasheets cannot be modified without permission.

This datasheet has been download from :

www.AllDataSheet.com

100% Free DataSheet Search Site.

Free Download.

No Register.

Fast Search System.

www.AllDataSheet.com