

Product Description

Stanford Microdevices' SGA-5263 is a high performance cascadeable 50-ohm amplifier designed for operation at voltages as low as 3.4V. This RFIC uses the latest Silicon Germanium Heterostructure Bipolar Transistor (SiGe HBT) process featuring 1 micron emitters with F_T up to 50 GHz.

This circuit uses a Darlington pair topology with resistive feedback for broadband performance as well as stability over its entire temperature range. Internally matched to 50 Ohm impedance, the SGA-5263 requires only DC blocking and bypass capacitors for external components.

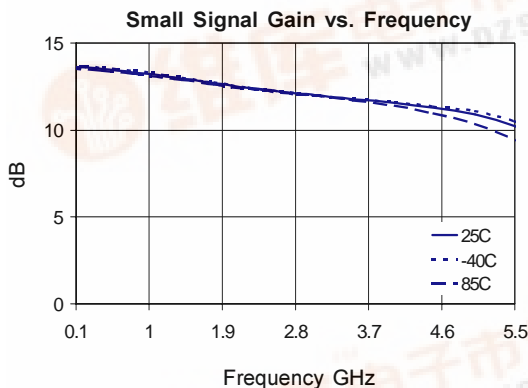

SGA-5263

DC-4500 MHz, Silicon Germanium Cascadeable Gain Block



Product Features

- DC-4500 MHz Operation
- Single Voltage Supply
- Low Current Draw: 60mA at 3.4V typ.
- High Output Intercept: 29 dBm typ. at 1950MHz

Applications

- Oscillator Amplifiers
- Broadband Gain Blocks
- IF/RF Buffer Amplifiers

Symbol	Parameters: Test Conditions: $Z_0 = 50$ Ohms, $I_D = 60$ mA, $T = 25^\circ\text{C}$	Units	Min.	Typ.	Max.
P_{1dB}	Output Power at 1dB Compression	f = 850 MHz f = 1950 MHz f = 2400 MHz	dBm dBm dBm	16.3 15.0 14.0	
IP_3	Third Order Intercept Point Power out per tone = -10 dBm	f = 850 MHz f = 1950 MHz f = 2400 MHz	dBm dBm dBm	32.5 29.3 27.3	
S_{21}	Small Signal Gain	f = 850 MHz f = 1950 MHz f = 2400 MHz	dB dB dB	13.3 12.6 12.3	
Bandwidth	S_{11}, S_{22} : Minimum 10db Return Loss (typ.)		MHz	4500	
S_{11}	Input VSWR	f = 1950 MHz	-	1.2:1	
S_{22}	Output VSWR	f = 1950 MHz	-	1.4:1	
S_{12}	Reverse Isolation	f = 850 MHz f = 1950 MHz f = 2400 MHz	dB dB dB	18.3 19.2 19.5	
NF	Noise Figure	f = 1950 MHz	dB	4.0	
V_D	Device Voltage		V	3.4	
R_{th}	Thermal Resistance (junction - lead)		$^\circ\text{C/W}$	255	



Preliminary

SGA-5263 DC-4.5 GHz 3.4V SiGe Amplifier

Absolute Maximum Ratings

Operation of this device above any one of these parameters may cause permanent damage.

Bias Conditions should also satisfy the following expression: $I_D V_D (\text{max}) < (T_J - T_{OP})/R_{th,j-l}$

Parameter	Value	Unit
Supply Current	120	mA
Device Voltage	6	V
Operating Temperature	-40 to +85	°C
Maximum Input Power	+10	dBm
Storage Temperature Range	-40 to +150	°C
Operating Junction Temperature	+150	°C

Key parameters, at typical operating frequencies:

Parameter	Typical 25°C	Unit	Test Condition ($I_b = 60\text{mA}$, unless otherwise noted)
100 MHz			
Gain	13.6	dB	Tone spacing = 1 MHz, Pout per tone = -10dBm $Z_s = 50 \text{ Ohms}$
Output IP3	33.6	dBm	
Output P1dB	16.1	dBm	
Input Return Loss	26.0	dB	
Reverse Isolation	17.7	dB	
Noise Figure	3.9	dB	
500 MHz			
Gain	13.5	dB	Tone spacing = 1 MHz, Pout per tone = -10dBm $Z_s = 50 \text{ Ohms}$
Output IP3	33.0	dBm	
Output P1dB	16.4	dBm	
Input Return Loss	23.5	dB	
Reverse Isolation	18.0	dB	
Noise Figure	3.9	dB	
850 MHz			
Gain	13.3	dB	Tone spacing = 1 MHz, Pout per tone = -10dBm $Z_s = 50 \text{ Ohms}$
Output IP3	32.5	dBm	
Output P1dB	16.3	dBm	
Input Return Loss	21.4	dB	
Reverse Isolation	18.3	dB	
Noise Figure	4.0	dB	
1950 MHz			
Gain	12.6	dB	Tone spacing = 1 MHz, Pout per tone = -10dBm $Z_s = 50 \text{ Ohms}$
Output IP3	29.3	dBm	
Output P1dB	15.0	dBm	
Input Return Loss	20.2	dB	
Reverse Isolation	19.2	dB	
Noise Figure	4.0	dB	
2400 MHz			
Gain	12.3	dB	Tone spacing = 1 MHz, Pout per tone = -10dBm
Output IP3	27.3	dBm	
Output P1dB	14.0	dBm	
Input Return Loss	23.0	dB	
Reverse Isolation	19.5	dB	
3500 MHz			
Gain	11.8	dB	Tone spacing = 1 MHz, Pout per tone = -10dBm
Output IP3	23.1	dBm	
Output P1dB	11.6	dBm	
Input Return Loss	24.6	dB	
Reverse Isolation	19.6	dB	

SGA-5263 DC-4.5 GHz 3.4V SiGe Amplifier

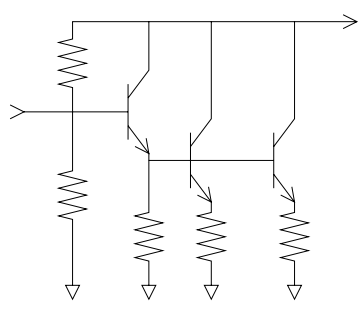
Pin #	Function	Description	Device Schematic
1	GND	Connection to ground. For best performance use via holes (as close to ground leads as possible) to reduce lead inductance.	
2	GND	Same as Pin 1	
3	RF IN	RF input pin. This pin requires the use of an external DC blocking capacitor chosen for the frequency of operation.	
4	GND	Same as Pin 1	
5	GND	Same as Pin 1	
6	RF OUT	RF output and bias pin. Bias should be supplied to this pin through an external series resistor and RF choke inductor. Because DC biasing is present on this pin, a DC blocking capacitor should be used in most applications (see application schematic). The supply side of this bias network should be well bypassed.	

Application Schematic

Recommended Bias Resistor Values				
Supply Voltage(Vs)	5V	7.5V	9V	12V
Rbias (Ohms)	27	68	91	140

Note: A bias resistor is needed for stability over temperature.

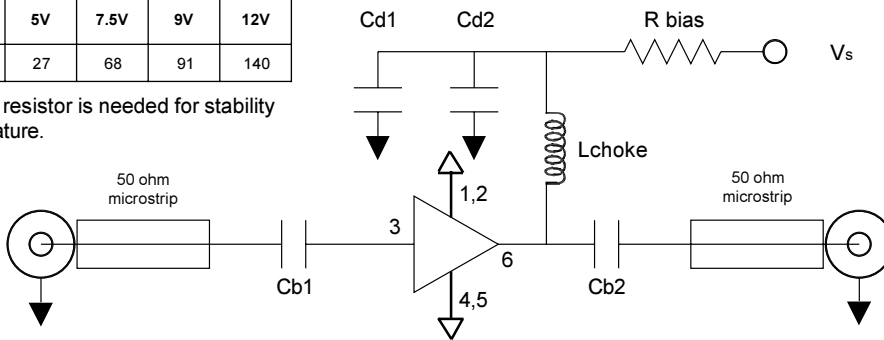

Reference Designator	Function	500 MHz	850 MHz	1950 MHz	2400 MHz
Cb1	DC Blocking	220 pF	100 pF	68 pF	56 pF
Cb2	DC Blocking	220 pF	100 pF	68 pF	56 pF
Cd1	Decoupling	1 uF	1 uF	1 uF	1 uF
Cd2	Decoupling	100 pF	68 pF	22 pF	22 pF
Lchoke	AC Blocking	68 nH	33 nH	22 nH	18 nH

SGA-5263 DC-4.5 GHz 3.4V SiGe Amplifier

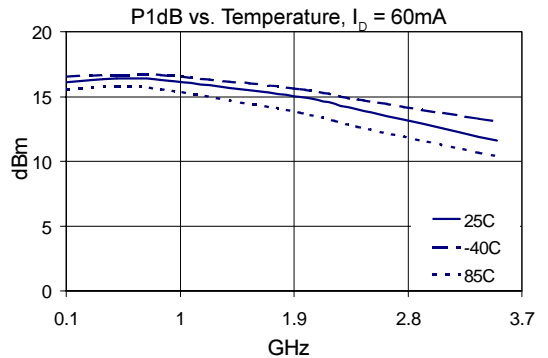
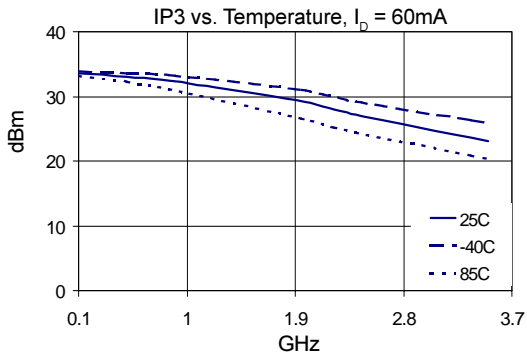
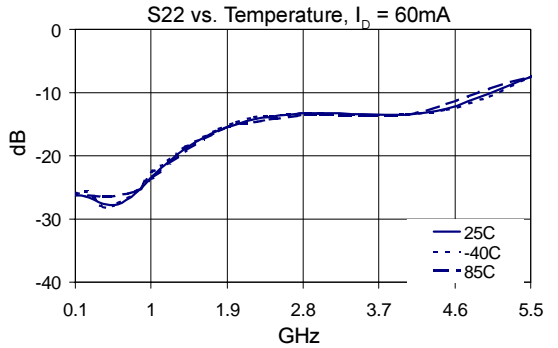
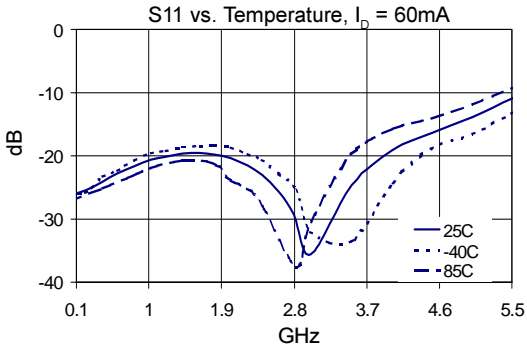
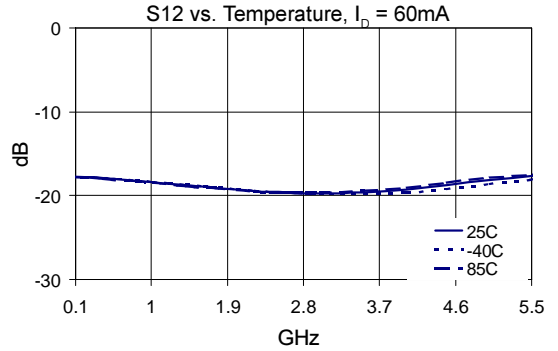
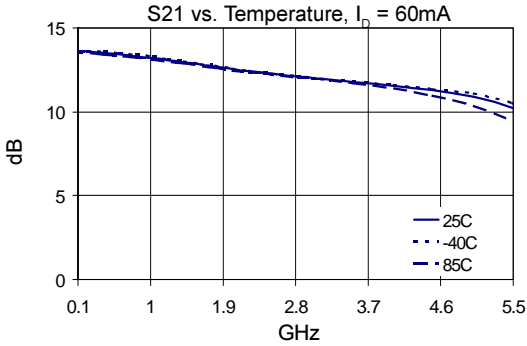

SGA-5263 DC-4.5 GHz 3.4V SiGe Amplifier



Caution: ESD sensitive

Appropriate precautions in handling, packaging and testing devices must be observed.

Part Number Ordering Information

Part Number	Reel Size	Devices/Reel
SGA-5263	7"	3000

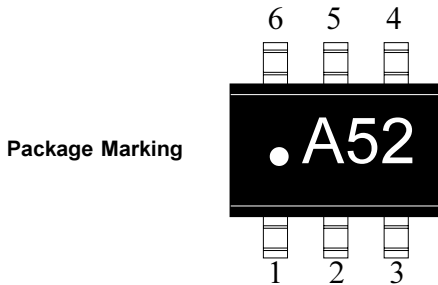

Note: Pin 1 is on lower left when you can read package marking

Package Dimensions

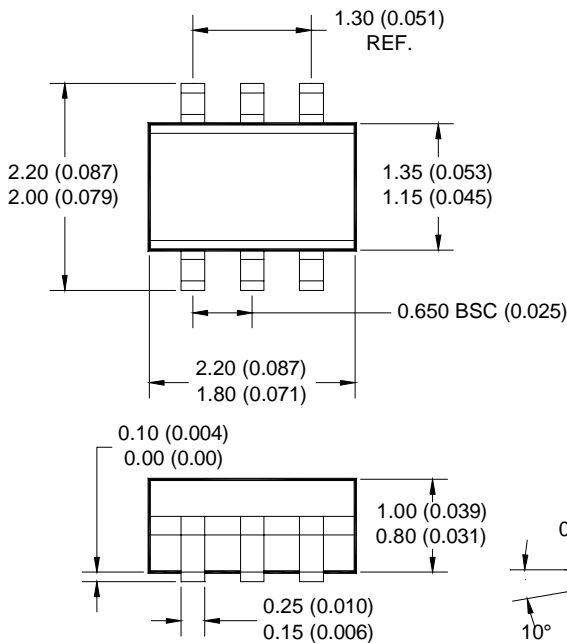

Pad Layout

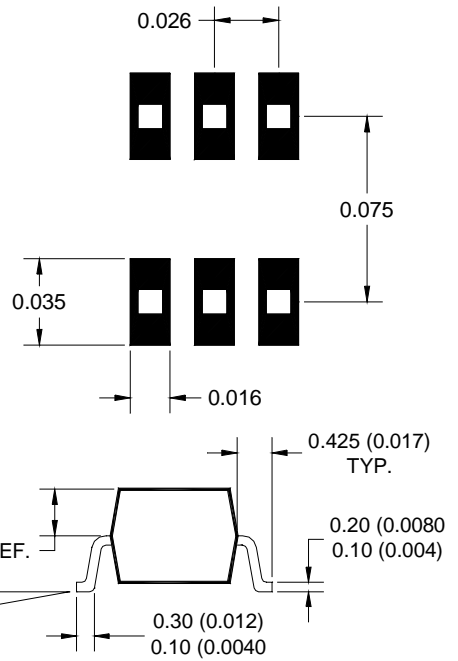

DIMENSIONS ARE IN INCHES [MM]