

High Speed IGBT in NPT-technology

- 30% lower E_{off} compared to previous generation
- Short circuit withstand time – 10 μ s
- Designed for operation above 30 kHz
- NPT-Technology for 600V applications offers:
 - parallel switching capability
 - moderate E_{off} increase with temperature
 - very tight parameter distribution
- High ruggedness, temperature stable behaviour
- Pb-free lead plating; RoHS compliant
- Qualified according to JEDEC¹ for target applications
- Complete product spectrum and PSpice Models : <http://www.infineon.com/igbt/>

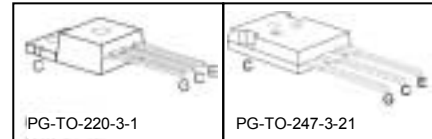
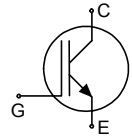

| Type | V_{CE} | I_C | E_{off} | T_j | Marking | Package |
|------------|----------|-------|-------------|-------|----------|----------------|
| SGP30N60HS | 600V | 30 | 480 μ J | 150°C | G30N60HS | PG-TO-220-3-1 |
| SGW30N60HS | 600V | 30 | 480 μ J | 150°C | G30N60HS | PG-TO-247-3-21 |

Maximum Ratings

| Parameter | Symbol | Value | Unit |
|---|----------------|----------------------|------------------|
| Collector-emitter voltage | V_{CE} | 600 | V |
| DC collector current | I_C | | A |
| $T_C = 25^\circ\text{C}$ | | 41 | |
| $T_C = 100^\circ\text{C}$ | | 30 | |
| Pulsed collector current, t_p limited by T_{jmax} | I_{Cpuls} | 112 | |
| Turn off safe operating area | - | 112 | |
| $V_{CE} \leq 600\text{V}, T_j \leq 150^\circ\text{C}$ | | | |
| Avalanche energy single pulse $I_C = 20\text{A}, V_{CC} = 50\text{V}, R_{GE} = 25\Omega$ start $T_j = 25^\circ\text{C}$ | E_{AS} | 165 | mJ |
| Gate-emitter voltage static transient ($t_p < 1\mu\text{s}, D < 0.05$) | V_{GE} | ± 20 ± 30 | V |
| Short circuit withstand time ²⁾ $V_{GE} = 15\text{V}, V_{CC} \leq 600\text{V}, T_j \leq 150^\circ\text{C}$ | t_{SC} | 10 | μs |
| Power dissipation $T_C = 25^\circ\text{C}$ | P_{tot} | 250 | W |
| Operating junction and storage temperature | T_j, T_{stg} | -55...+150 | $^\circ\text{C}$ |
| Time limited operating junction temperature for $t < 150\text{h}$ | $T_{j(tl)}$ | 175 | |
| Soldering temperature, 1.6mm (0.063 in.) from case for 10s | - | 260 | |

¹ J-STD-020 and JESD-022

²⁾ Allowed number of short circuits: <1000; time between short circuits: >1s.

Thermal Resistance

| Parameter | Symbol | Conditions | Max. Value | Unit |
|--|------------|----------------|------------|------|
| Characteristic | | | | |
| IGBT thermal resistance, junction – case | R_{thJC} | | 0.5 | K/W |
| Thermal resistance, junction – ambient | R_{thJA} | PG-TO-220-3-1 | 62 | |
| | | PG-TO-247-3-21 | 40 | |

Electrical Characteristic, at $T_j = 25^\circ\text{C}$, unless otherwise specified

| Parameter | Symbol | Conditions | Value | | | Unit |
|--------------------------------------|---------------|---|-------|------|------|---------|
| | | | min. | Typ. | max. | |
| Static Characteristic | | | | | | |
| Collector-emitter breakdown voltage | $V_{(BR)CES}$ | $V_{GE}=0V, I_C=500\mu A$ | 600 | - | - | V |
| Collector-emitter saturation voltage | $V_{CE(sat)}$ | $V_{GE} = 15V, I_C=30A$ $T_j=25^\circ\text{C}$ $T_j=150^\circ\text{C}$ | | 2.8 | 3.15 | |
| | | | | 3.5 | 4.00 | |
| Gate-emitter threshold voltage | $V_{GE(th)}$ | $I_C=700\mu A, V_{CE}=V_{GE}$ | 3 | 4 | 5 | |
| Zero gate voltage collector current | I_{CES} | $V_{CE}=600V, V_{GE}=0V$ $T_j=25^\circ\text{C}$ $T_j=150^\circ\text{C}$ | | - | 40 | μA |
| | | | | - | 3000 | |
| Gate-emitter leakage current | I_{GES} | $V_{CE}=0V, V_{GE}=20V$ | - | - | 100 | nA |
| Transconductance | g_{fs} | $V_{CE}=20V, I_C=30A$ | - | 20 | - | S |

Dynamic Characteristic

| | | | | | | |
|--|-------------|---|---|------|--|----|
| Input capacitance | C_{iss} | $V_{CE}=25V,$ $V_{GE}=0V,$ $f=1\text{MHz}$ | - | 1500 | | pF |
| Output capacitance | C_{oss} | | - | 150 | | |
| Reverse transfer capacitance | C_{riss} | | - | 92 | | |
| Gate charge | Q_{Gate} | $V_{CC}=480V, I_C=30A$ $V_{GE}=15V$ | - | 141 | | nC |
| Internal emitter inductance measured 5mm (0.197 in.) from case | L_E | PG-TO-220-3-1 | - | 7 | | nH |
| | | PG-TO-247-3-21 | | 13 | | |
| Short circuit collector current ¹⁾ | $I_{C(SC)}$ | $V_{GE}=15V, t_{SC}\leq 10\mu s$ $V_{CC}\leq 600V,$ $T_j\leq 150^\circ\text{C}$ | - | 220 | | A |

¹⁾ Allowed number of short circuits: <1000; time between short circuits: >1s.

Switching Characteristic, Inductive Load, at $T_j=25^\circ\text{C}$

| Parameter | Symbol | Conditions | Value | | | Unit |
|----------------------------|--------------|--|-------|------|------|------|
| | | | min. | typ. | max. | |
| IGBT Characteristic | | | | | | |
| Turn-on delay time | $t_{d(on)}$ | $T_j=25^\circ\text{C}$, $V_{CC}=400\text{V}$, $I_C=30\text{A}$, $V_{GE}=0/15\text{V}$, $R_G=11\Omega$ $L_{\sigma}^{(1)}=60\text{nH}$, $C_{\sigma}^{(1)}=40\text{pF}$ Energy losses include "tail" and diode reverse recovery. | - | 20 | | ns |
| Rise time | t_r | | - | 21 | | |
| Turn-off delay time | $t_{d(off)}$ | | - | 250 | | |
| Fall time | t_f | | - | 25 | | |
| Turn-on energy | E_{on} | | - | 0.60 | | mJ |
| Turn-off energy | E_{off} | | - | 0.55 | | |
| Total switching energy | E_{ts} | | - | 1.15 | | |

Switching Characteristic, Inductive Load, at $T_j=150^\circ\text{C}$

| Parameter | Symbol | Conditions | Value | | | Unit |
|----------------------------|--------------|--|-------|------|------|------|
| | | | min. | typ. | max. | |
| IGBT Characteristic | | | | | | |
| Turn-on delay time | $t_{d(on)}$ | $T_j=150^\circ\text{C}$ $V_{CC}=400\text{V}$, $I_C=30\text{A}$, $V_{GE}=0/15\text{V}$, $R_G=1.8\Omega$ $L_{\sigma}^{(1)}=60\text{nH}$, $C_{\sigma}^{(1)}=40\text{pF}$ Energy losses include "tail" and diode reverse recovery. | - | 16 | | ns |
| Rise time | t_r | | - | 13 | | |
| Turn-off delay time | $t_{d(off)}$ | | - | 122 | | |
| Fall time | t_f | | - | 29 | | |
| Turn-on energy | E_{on} | | - | 0.78 | | mJ |
| Turn-off energy | E_{off} | | - | 0.48 | | |
| Total switching energy | E_{ts} | | - | 1.26 | | |
| Turn-on delay time | $t_{d(on)}$ | $T_j=150^\circ\text{C}$ $V_{CC}=400\text{V}$, $I_C=30\text{A}$, $V_{GE}=0/15\text{V}$, $R_G=11\Omega$ $L_{\sigma}^{(1)}=60\text{nH}$, $C_{\sigma}^{(1)}=40\text{pF}$ Energy losses include "tail" and diode reverse recovery. | - | 20 | | ns |
| Rise time | t_r | | - | 19 | | |
| Turn-off delay time | $t_{d(off)}$ | | - | 274 | | |
| Fall time | t_f | | - | 27 | | |
| Turn-on energy | E_{on} | | - | 0.91 | | mJ |
| Turn-off energy | E_{off} | | - | 0.70 | | |
| Total switching energy | E_{ts} | | - | 1.61 | | |

¹⁾ Leakage inductance L_{σ} and Stray capacity C_{σ} due to test circuit in Figure E.

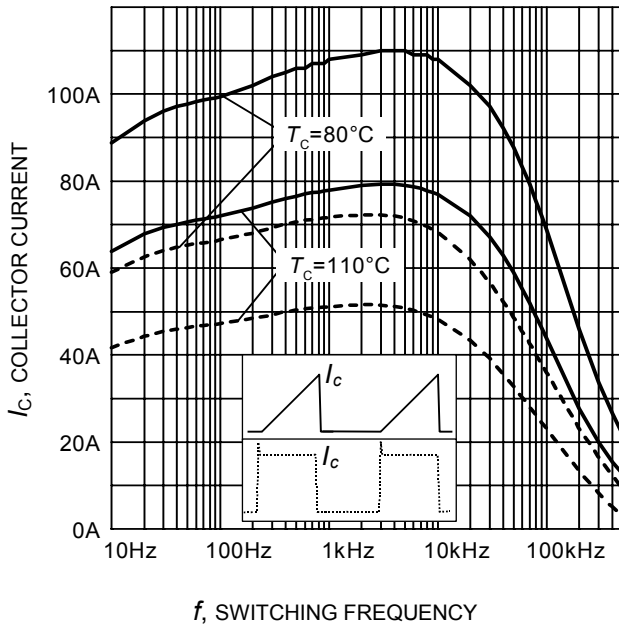

Figure 1. Collector current as a function of switching frequency
 ($T_j \leq 150^\circ\text{C}$, $D = 0.5$, $V_{CE} = 400\text{V}$,
 $V_{GE} = 0/+15\text{V}$, $R_G = 11\Omega$)

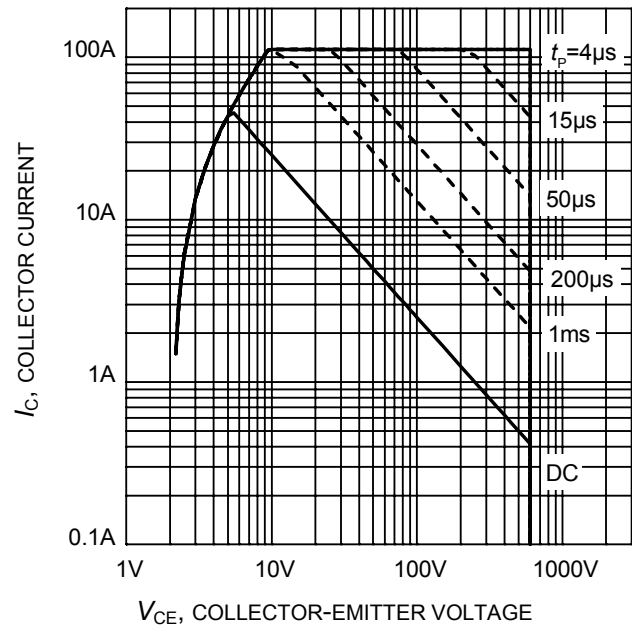

Figure 2. Safe operating area
 ($D = 0$, $T_C = 25^\circ\text{C}$, $T_j \leq 150^\circ\text{C}$;
 $V_{GE} = 15\text{V}$)

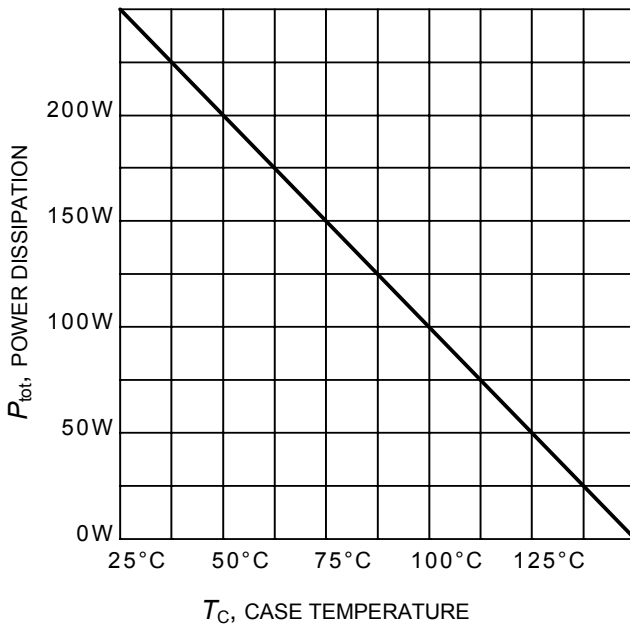

Figure 3. Power dissipation as a function of case temperature
 ($T_j \leq 150^\circ\text{C}$)

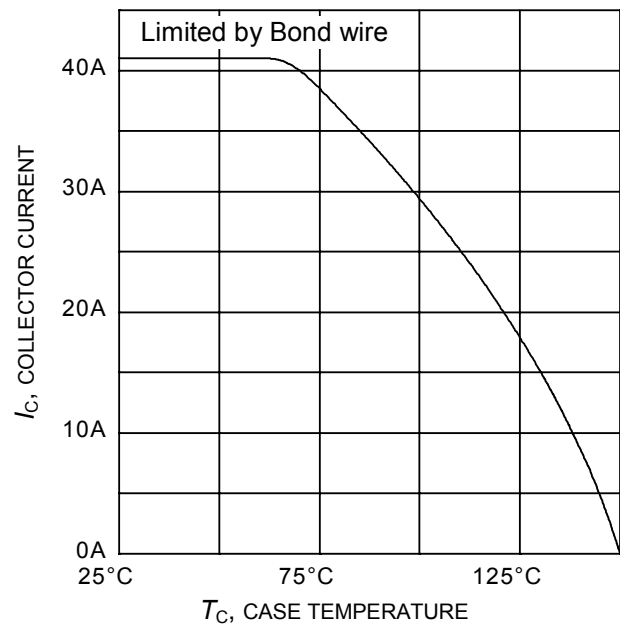

Figure 4. Collector current as a function of case temperature
 ($V_{GE} \leq 15\text{V}$, $T_j \leq 150^\circ\text{C}$)

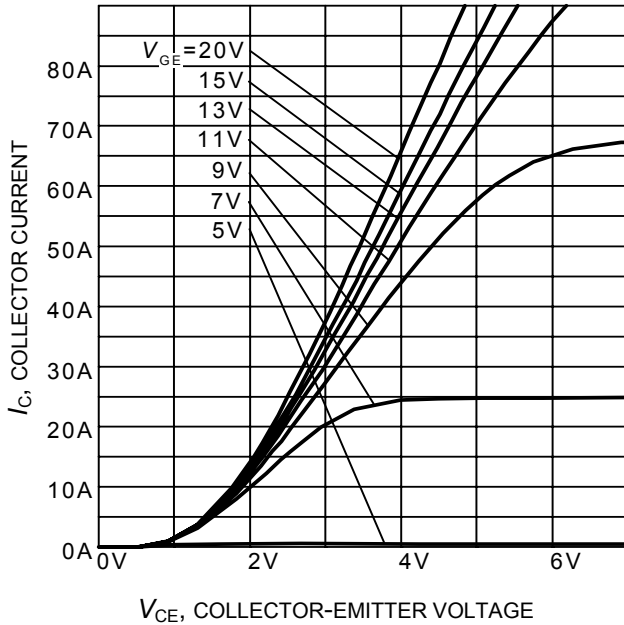

Figure 5. Typical output characteristic
($T_j = 25^\circ\text{C}$)

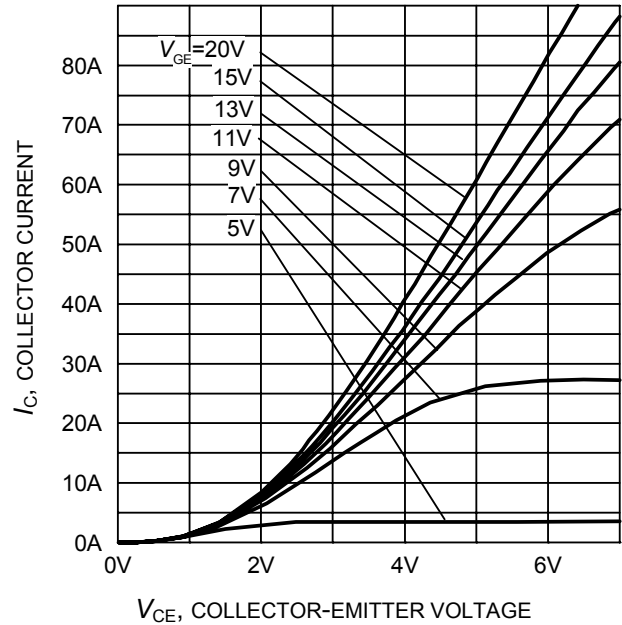

Figure 6. Typical output characteristic
($T_j = 150^\circ\text{C}$)

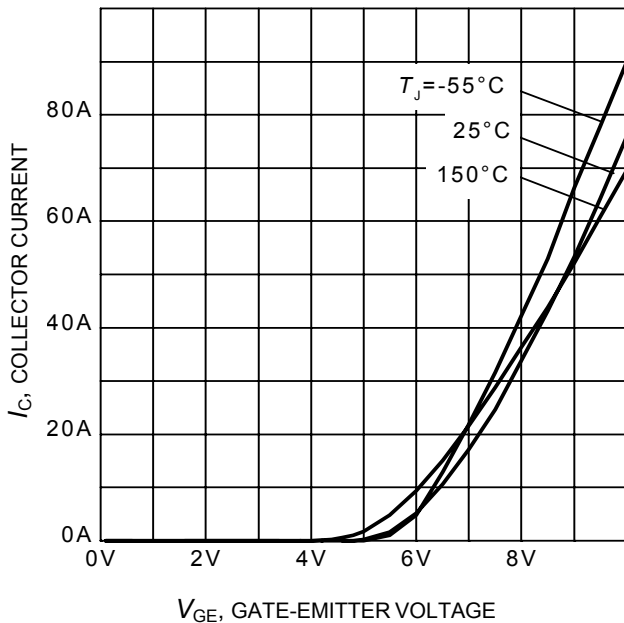

Figure 7. Typical transfer characteristic
($V_{CE} = 10\text{V}$)

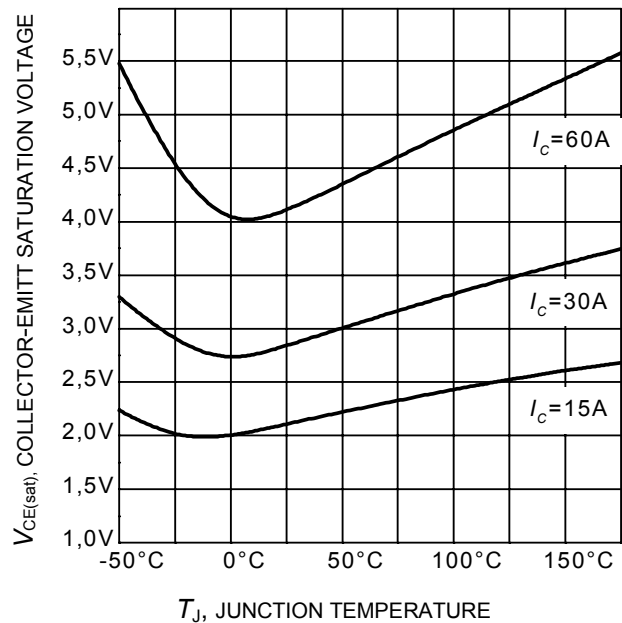

Figure 8. Typical collector-emitter saturation voltage as a function of junction temperature
($V_{GE} = 15\text{V}$)

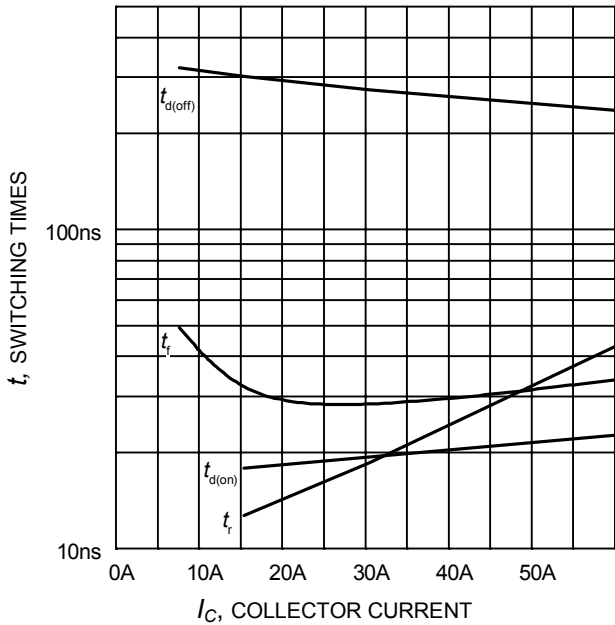

Figure 9. Typical switching times as a function of collector current
(inductive load, $T_J=150^{\circ}\text{C}$, $V_{CE}=400\text{V}$, $V_{GE}=0/15\text{V}$, $R_G=11\Omega$, Dynamic test circuit in Figure E)

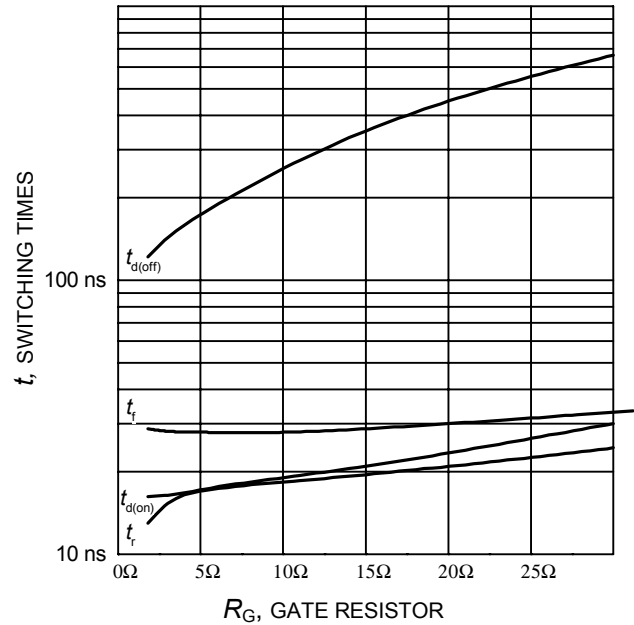

Figure 10. Typical switching times as a function of gate resistor
(inductive load, $T_J=150^{\circ}\text{C}$, $V_{CE}=400\text{V}$, $V_{GE}=0/15\text{V}$, $I_C=30\text{A}$, Dynamic test circuit in Figure E)

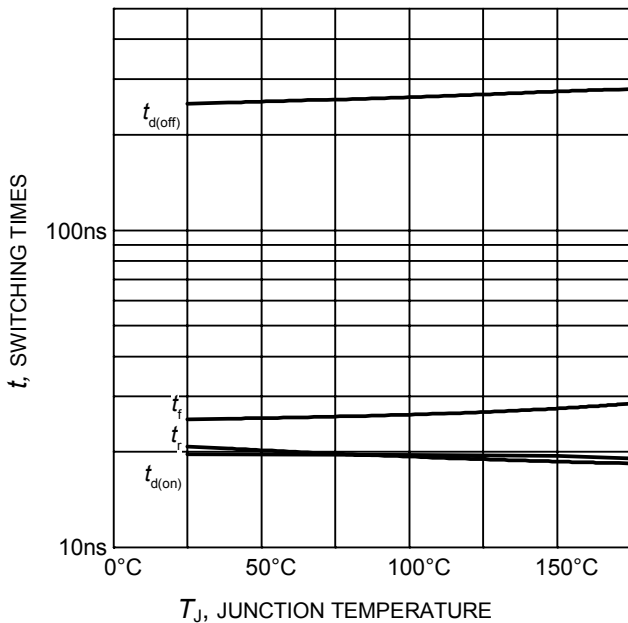

Figure 11. Typical switching times as a function of junction temperature
(inductive load, $V_{CE}=400\text{V}$, $V_{GE}=0/15\text{V}$, $I_C=30\text{A}$, $R_G=11\Omega$, Dynamic test circuit in Figure E)

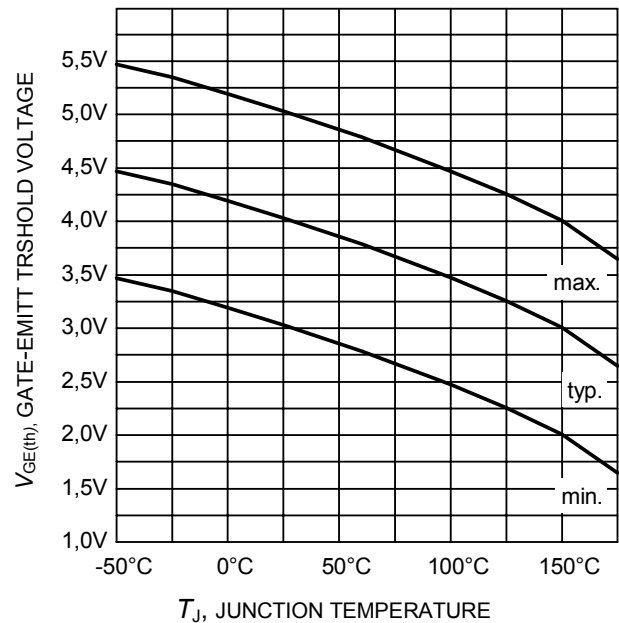

Figure 12. Gate-emitter threshold voltage as a function of junction temperature
($I_C = 0.7\text{mA}$)

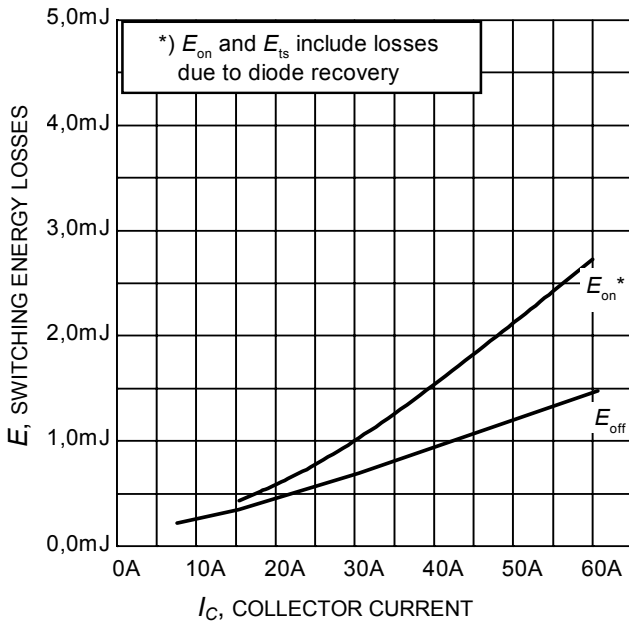

Figure 13. Typical switching energy losses as a function of collector current
(inductive load, $T_J=150^\circ\text{C}$, $V_{CE}=400\text{V}$, $V_{GE}=0/15\text{V}$, $R_G=11\Omega$, Dynamic test circuit in Figure E)

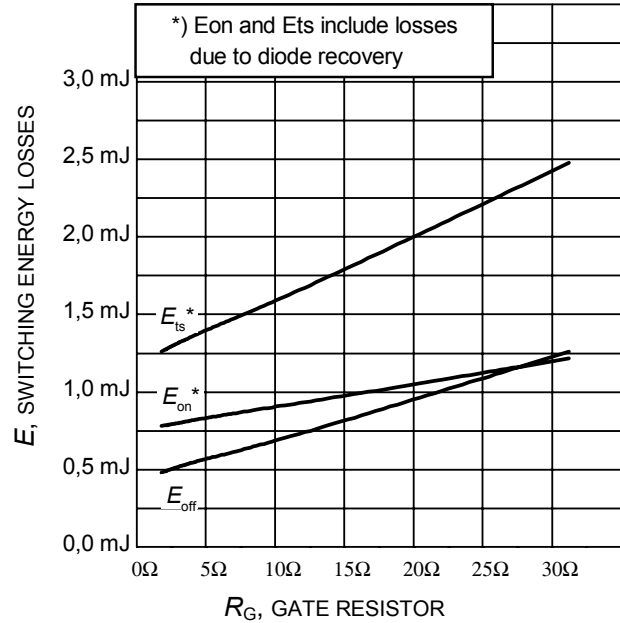

Figure 14. Typical switching energy losses as a function of gate resistor
(inductive load, $T_J=150^\circ\text{C}$, $V_{CE}=400\text{V}$, $V_{GE}=0/15\text{V}$, $I_C=30\text{A}$, Dynamic test circuit in Figure E)

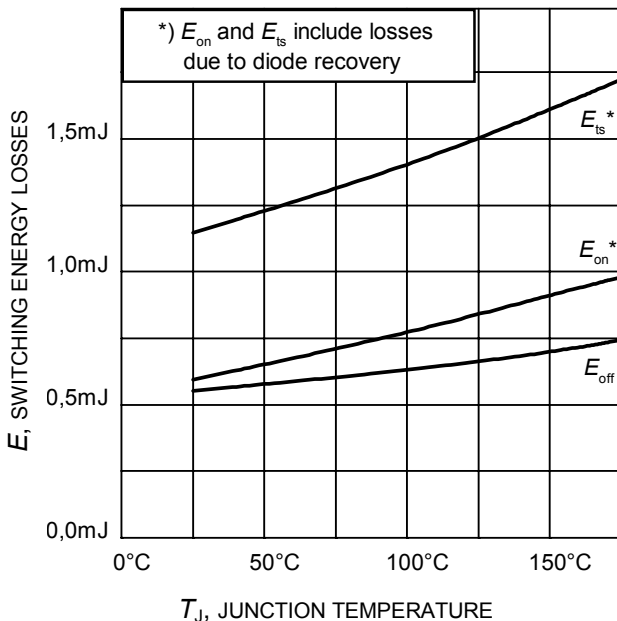

Figure 15. Typical switching energy losses as a function of junction temperature
(inductive load, $V_{CE}=400\text{V}$, $V_{GE}=0/15\text{V}$, $I_C=30\text{A}$, $R_G=11\Omega$, Dynamic test circuit in Figure E)

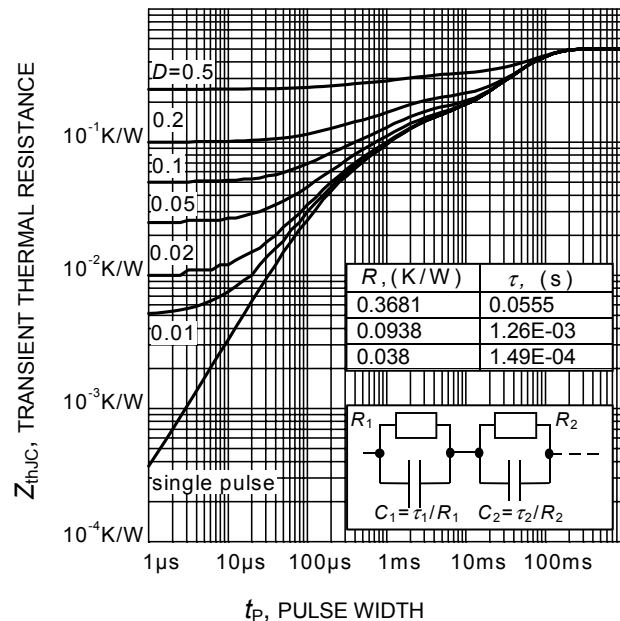

Figure 16. IGBT transient thermal resistance
($D = t_p / T$)

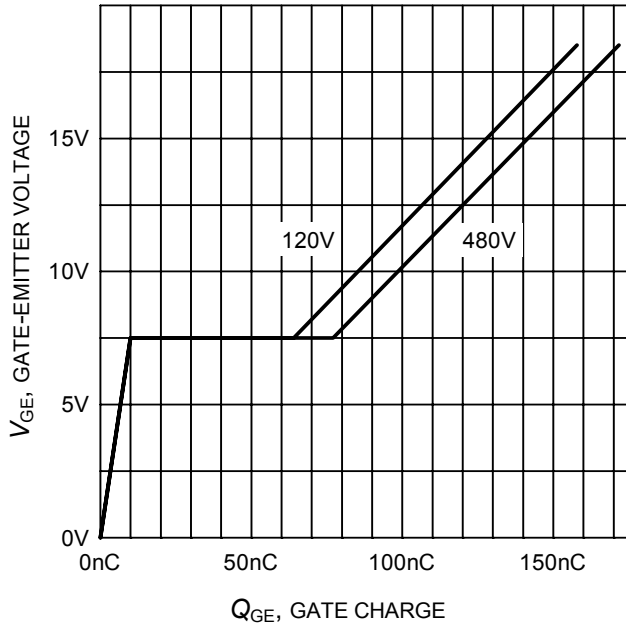

Figure 17. Typical gate charge
($I_C=30\text{ A}$)

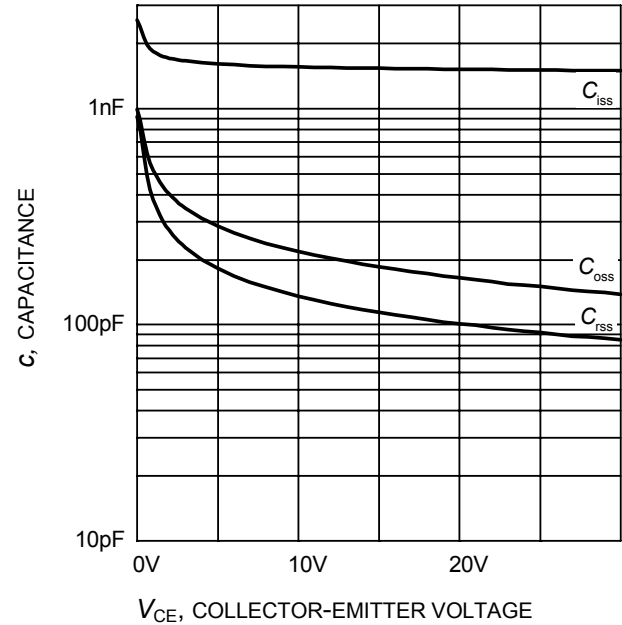

Figure 18. Typical capacitance as a function of collector-emitter voltage
($V_{GE}=0\text{V}$, $f = 1\text{ MHz}$)

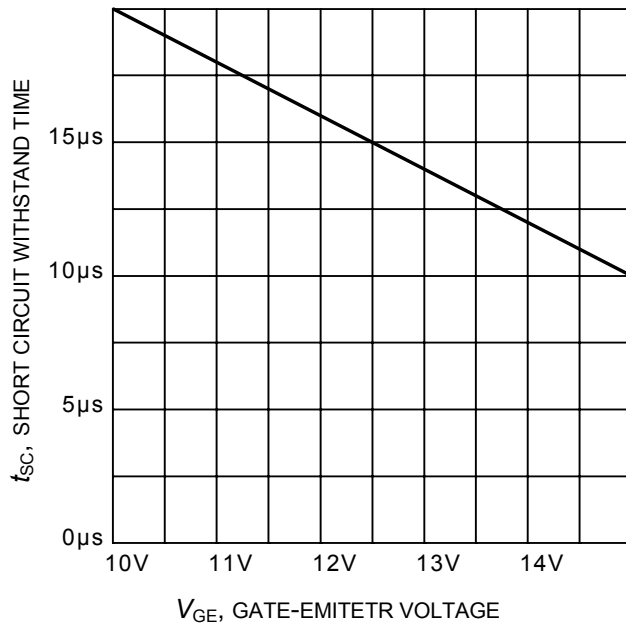

Figure 19. Short circuit withstand time as a function of gate-emitter voltage
($V_{CE}=600\text{V}$, start at $T_J=25^\circ\text{C}$)

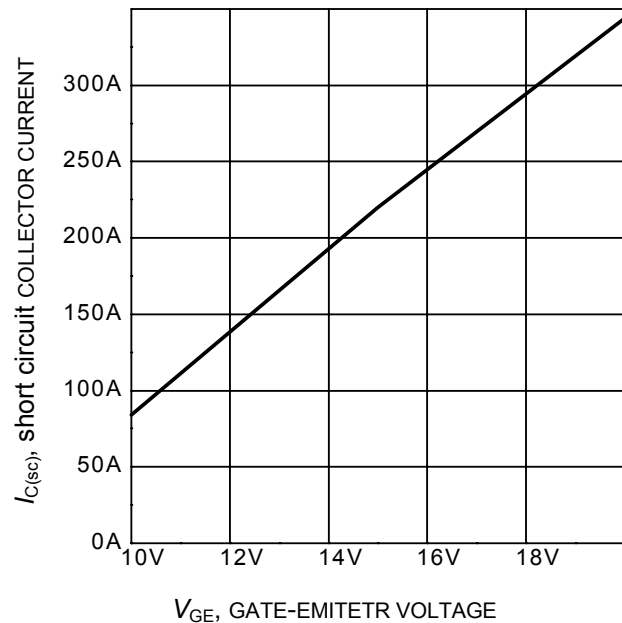
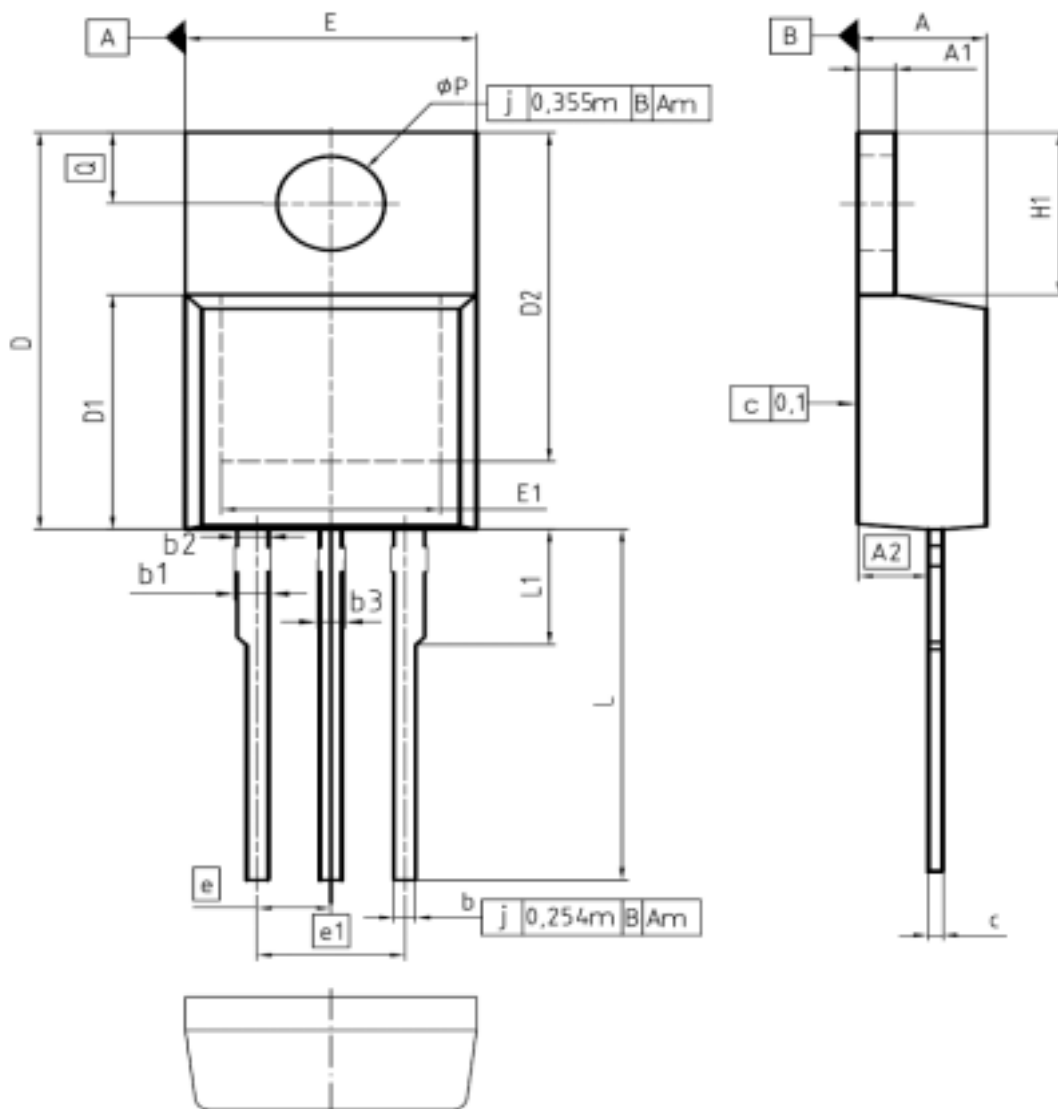

Figure 20. Typical short circuit collector current as a function of gate-emitter voltage
($V_{CE} \leq 600\text{V}$, $T_J \leq 150^\circ\text{C}$)

PG-TO220-3-1



| DIM | MILLIMETERS | | INCHES | |
|----------|-------------|-------|--------|-------|
| | MIN | MAX | MIN | MAX |
| A | 4.30 | 4.57 | 0.169 | 0.180 |
| A1 | 1.17 | 1.40 | 0.046 | 0.055 |
| A2 | 2.15 | 2.72 | 0.085 | 0.107 |
| b | 0.65 | 0.86 | 0.026 | 0.034 |
| b1 | 0.95 | 1.40 | 0.037 | 0.055 |
| b2 | 0.95 | 1.15 | 0.037 | 0.045 |
| b3 | 0.65 | 1.15 | 0.026 | 0.045 |
| c | 0.33 | 0.60 | 0.013 | 0.024 |
| D | 14.81 | 15.95 | 0.583 | 0.628 |
| D1 | 8.51 | 9.45 | 0.335 | 0.372 |
| D2 | 12.19 | 13.10 | 0.480 | 0.516 |
| E | 9.70 | 10.36 | 0.382 | 0.408 |
| E1 | 6.50 | 8.60 | 0.256 | 0.339 |
| e | 2.54 | | 0.100 | |
| e1 | 5.08 | | 0.200 | |
| N | 3 | | 3 | |
| H1 | 5.90 | 6.90 | 0.232 | 0.272 |
| L | 13.00 | 14.00 | 0.512 | 0.551 |
| L1 | - | 4.80 | - | 0.189 |
| ϕP | 3.60 | 3.89 | 0.142 | 0.153 |
| Q | 2.60 | 3.00 | 0.102 | 0.118 |

DOCUMENT NO.
Z8B00003318

SCALE

EUROPEAN PROJECTION

ISSUE DATE
23-08-2007

REVISION
05

PG-TO247-3-21

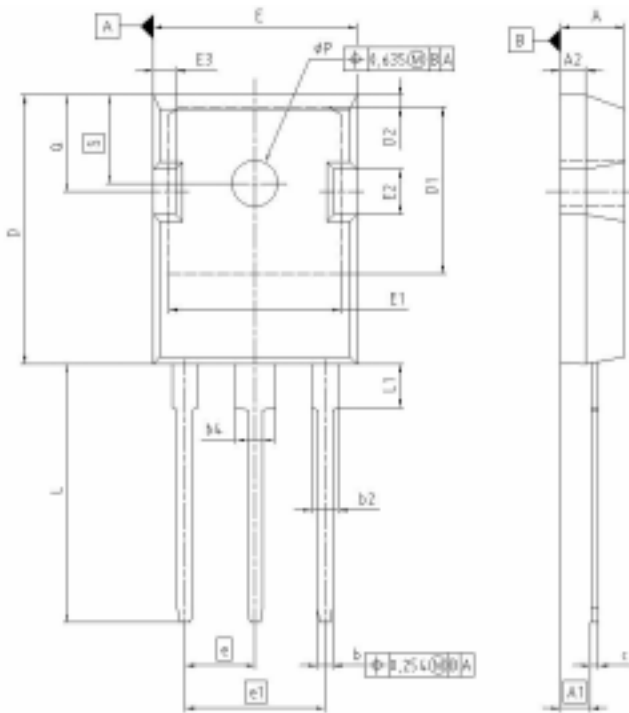

| DIM | MILLIMETERS | | INCHES | |
|----------|-------------|--------|--------|-------|
| | MIN | MAX | MIN | MAX |
| A | 4.900 | 5.157 | 0.193 | 0.203 |
| A1 | 2.275 | 2.527 | 0.090 | 0.100 |
| A2 | 1.653 | 2.107 | 0.075 | 0.083 |
| b | 1.073 | 1.327 | 0.042 | 0.052 |
| b2 | 1.903 | 2.388 | 0.075 | 0.094 |
| b4 | 2.870 | 3.454 | 0.113 | 0.136 |
| c | 0.549 | 0.752 | 0.021 | 0.030 |
| D | 20.823 | 21.077 | 0.820 | 0.830 |
| D1 | 17.323 | 17.831 | 0.682 | 0.702 |
| D2 | 1.063 | 1.317 | 0.042 | 0.052 |
| E | 15.773 | 16.027 | 0.621 | 0.631 |
| E1 | 13.893 | 14.147 | 0.547 | 0.557 |
| E2 | 3.683 | 3.057 | 0.145 | 0.155 |
| E3 | 1.803 | 1.907 | 0.070 | 0.076 |
| e | 5.450 | | 0.215 | |
| e1 | 10.900 | | 0.430 | |
| N | 3 | | 3 | |
| L | 20.953 | 20.307 | 0.799 | 0.799 |
| L1 | 4.166 | 4.472 | 0.164 | 0.175 |
| ϕP | 3.259 | 3.261 | 0.128 | 0.128 |
| Q | 5.405 | 5.747 | 0.213 | 0.226 |
| S | 6.043 | 6.297 | 0.238 | 0.248 |

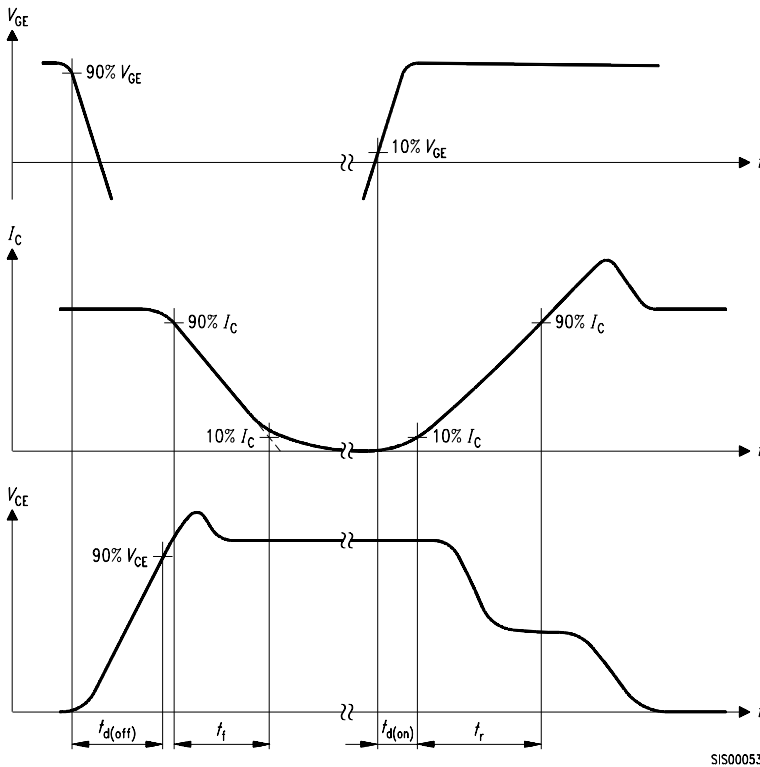

Figure A. Definition of switching times

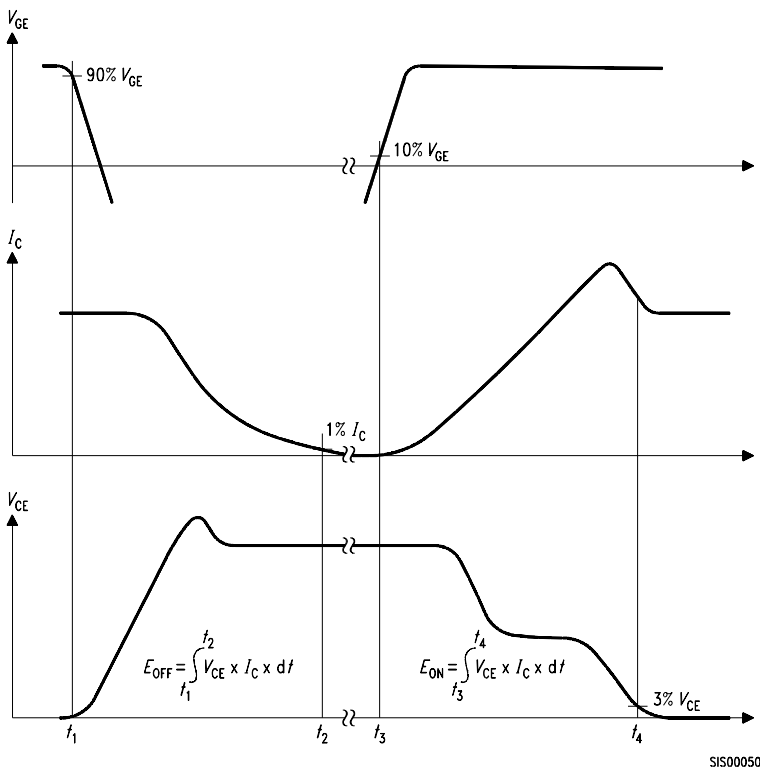

Figure B. Definition of switching losses

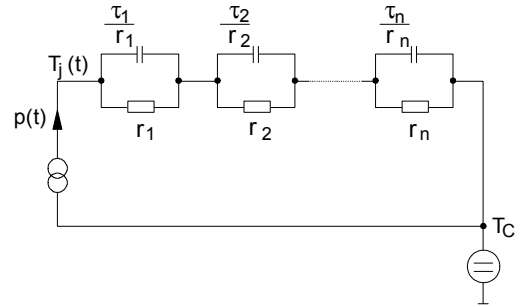

Figure D. Thermal equivalent circuit

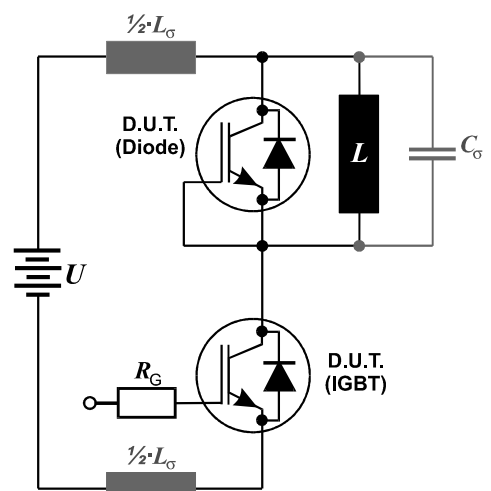

Figure E. Dynamic test circuit
Leakage inductance $L_{\sigma} = 60\text{nH}$
and Stray capacity $C_{\sigma} = 40\text{pF}$.

Edition 2006-01

**Published by
Infineon Technologies AG
81726 München, Germany**

**© Infineon Technologies AG 9/12/07.
All Rights Reserved.**

Attention please!

The information given in this data sheet shall in no event be regarded as a guarantee of conditions or characteristics ("Beschaffheitsgarantie"). With respect to any examples or hints given herein, any typical values stated herein and/or any information regarding the application of the device, Infineon Technologies hereby disclaims any and all warranties and liabilities of any kind, including without limitation warranties of non-infringement of intellectual property rights of any third party.

Information

For further information on technology, delivery terms and conditions and prices please contact your nearest Infineon Technologies Office (www.infineon.com).

Warnings

Due to technical requirements components may contain dangerous substances. For information on the types in question please contact your nearest Infineon Technologies Office.

Infineon Technologies Components may only be used in life-support devices or systems with the express written approval of Infineon Technologies, if a failure of such components can reasonably be expected to cause the failure of that life-support device or system, or to affect the safety or effectiveness of that device or system. Life support devices or systems are intended to be implanted in the human body, or to support and/or maintain and sustain and/or protect human life. If they fail, it is reasonable to assume that the health of the user or other persons may be endangered.