

SI-3000KS Series

Surface-Mount, Low Current Consumption, Low Dropout Voltage Dropper Type

■Features

- Compact surface-mount package (SOP-8)
- Output current: 1.0 A
- Low-ESR capacitor can be used.
- Low current consumption $I_q \leq 350 \mu A$ ($I_o = 0 A, V_c = 2 V$)
- Low current consumption I_q (OFF) $\leq 1 \mu A$ ($V_c = 0 V$)
- Low dropout voltage $V_{DIF} \leq 0.6 V$ ($I_o = 1 A$)
- 4 types of output voltages (1.8 V, 2.5 V, 3.3 V, and variable type) available
- Output ON/OFF control pin compatible with LS-TTL
- Built-in dropping type overcurrent, thermal protection circuits

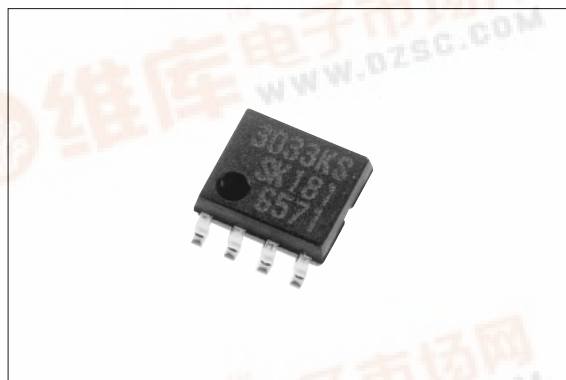

■Applications

- Local power supplies
- Battery-driven electronic equipment

■Absolute Maximum Ratings

($T_a=25^\circ C$)

Parameter	Symbol	Ratings	Unit
DC Input Voltage	V_{IN}^{*1}	17	V
Output Control Pin Voltage	V_c	V_{IN}	V
Output Current	I_o^{*1}	1.0	A
Power Dissipation	$P_D^{*1, *2}$	0.76	W
Junction Temperature	T_j	-40 to +125	$^\circ C$
Storage Temperature	T_{stg}	-40 to +125	$^\circ C$
Thermal Resistance (Junction to Ambient Air)	$R_{th(j-a)}^*$	130	$^\circ C/W$
Thermal resistance (Junction to Lead (pin 7))	$R_{th(j-l)}$	22	$^\circ C/W$

*1: V_{IN} (max) and I_o (max) are restricted by the relationship $P_D = (V_{IN} - V_o) \times I_o$. Calculate these values referring to the power dissipation vs. copper area data shown in this document.

*2: When mounted on a glass epoxy board measuring 1600 mm² (with 2% copper area).

■Electrical Characteristics

(Unless otherwise specified, $T_a = 25^\circ\text{C}$, $V_c = 2\text{V}$)

Parameter	Symbol	Ratings											Unit	
		SI-3012KS (variable type)			SI-3018KS			SI-3025KS			SI-3033KS			
		min.	typ.	max.	min.	typ.	max.	min.	typ.	max.	min.	typ.	max.	
Input Voltage	V_{IN}	2.4			*1			*1			*1			
Output Voltage (reference voltage for SI-3102KS)	V_O (V_{REF})	1.24	1.28	1.32	1.764	1.800	1.836	2.45	2.50	2.55	3.234	3.300	3.366	V
Dropout Voltage	V_{DIF}			0.3			-			0.4			0.4	V
	Conditions	$V_{IN}=3.3\text{V}$, $I_O=10\text{mA}$			$V_{IN}=2.5\text{V}$, $I_O=10\text{mA}$			$V_{IN}=3.3\text{V}$, $I_O=10\text{mA}$			$V_{IN}=5\text{V}$, $I_O=10\text{mA}$			
	Conditions	$I_O=0.5\text{A}$ ($V_O=2.5\text{V}$)			-			$I_O=0.5\text{A}$			$I_O=0.5\text{A}$			
Line Regulation	ΔV_{OLINE}			10			10			10			15	mV
	Conditions	$V_{IN}=3.3$ to 8V , $I_O=10\text{mA}$ ($V_O=2.5\text{V}$)			$V_{IN}=2.5$ to 6V , $I_O=10\text{mA}$			$V_{IN}=3.3$ to 8V , $I_O=10\text{mA}$			$V_{IN}=5$ to 10V , $I_O=10\text{mA}$			
Load Regulation	ΔV_{OLOAD}			40			40			40			50	mV
	Conditions	$V_{IN}=3.3\text{V}$, $I_O=0$ to 1A ($V_O=2.5\text{V}$)			$V_{IN}=2.5\text{V}$, $I_O=0$ to 1A			$V_{IN}=3.3\text{V}$, $I_O=0$ to 1A			$V_{IN}=5\text{V}$, $I_O=0$ to 1A			
Quiescent Circuit Current	I_q			350			350			350			350	μA
	Conditions	$V_{IN}=3.3\text{V}$, $I_O=0\text{A}$, $V_C=2\text{V}$, $R_2=24\text{k}\Omega$			$V_{IN}=2.5\text{V}$, $I_O=0\text{A}$, $V_C=2\text{V}$			$V_{IN}=3.3\text{V}$, $I_O=0\text{A}$, $V_C=2\text{V}$			$V_{IN}=5\text{V}$, $I_O=0\text{A}$, $V_C=2\text{V}$			
Off Circuit Current	$I_q(\text{OFF})$			1			1			1			1	μA
	Conditions	$V_{IN}=3.3\text{V}$, $V_C=0\text{V}$			$V_{IN}=2.5\text{V}$, $V_C=0\text{V}$			$V_{IN}=3.3\text{V}$, $V_C=0\text{V}$			$V_{IN}=5\text{V}$, $V_C=0\text{V}$			
Temperature Coefficient of Output Voltage	$\Delta V_O/\Delta T_a$		± 0.3			± 0.3			± 0.3			± 0.3		mV/ $^\circ\text{C}$
	Conditions	$T_j=0$ to 100°C ($V_O=2.5\text{V}$)			$T_j=0$ to 100°C			$T_j=0$ to 100°C			$T_j=0$ to 100°C			
Ripple Rejection	R_{REJ}		55			55			55			55		dB
	Conditions	$V_{IN}=3.3\text{V}$, $f=100$ to 120Hz ($V_O=2.5\text{V}$)			$V_{IN}=3.3\text{V}$, $f=100$ to 120Hz			$V_{IN}=3.3\text{V}$, $f=100$ to 120Hz			$V_{IN}=5\text{V}$, $f=100$ to 120Hz			
Overcurrent Protection Starting Current*2	I_{S1}	1.2			1.2			1.2			1.2			A
	Conditions	$V_{IN}=3.3\text{V}$ ($V_O=2.5\text{V}$)			$V_{IN}=2.5\text{V}$			$V_{IN}=3.3\text{V}$			$V_{IN}=5\text{V}$			
VC PIN	Control Voltage (Output ON)*3	V_C , IH	2.0			2.0			2.0			2.0		V
	Control Voltage (Output OFF)	V_C , IL			0.8			0.8			0.8		0.8	
	Control Current (Output ON)	I_C , IH			40			40			40		40	μA
	Conditions	$V_C=2\text{V}$												
Control Current (Output OFF)	I_C , IL	-5	0		-5	0		-5	0		-5	0	μA	
Conditions	$V_C=0\text{V}$													
Output OFF Voltage	$V_O(\text{OFF})$			0.5			0.5			0.5			0.5	V

*1: Refer to the description on the dropout voltage.

*2: The I_{S1} is specified as the 5% drop point of output voltage V_O on the condition that $V_{IN} = V_O + 1\text{V}$, and $I_O = 10\text{mA}$.

*3: Output is OFF when the output control pin (V_C pin) is open. Each input level is equivalent to that for LS-TTL. Therefore, the device can be driven directly by an LS-TTL circuit.

■External Dimensions

(Unit : mm)

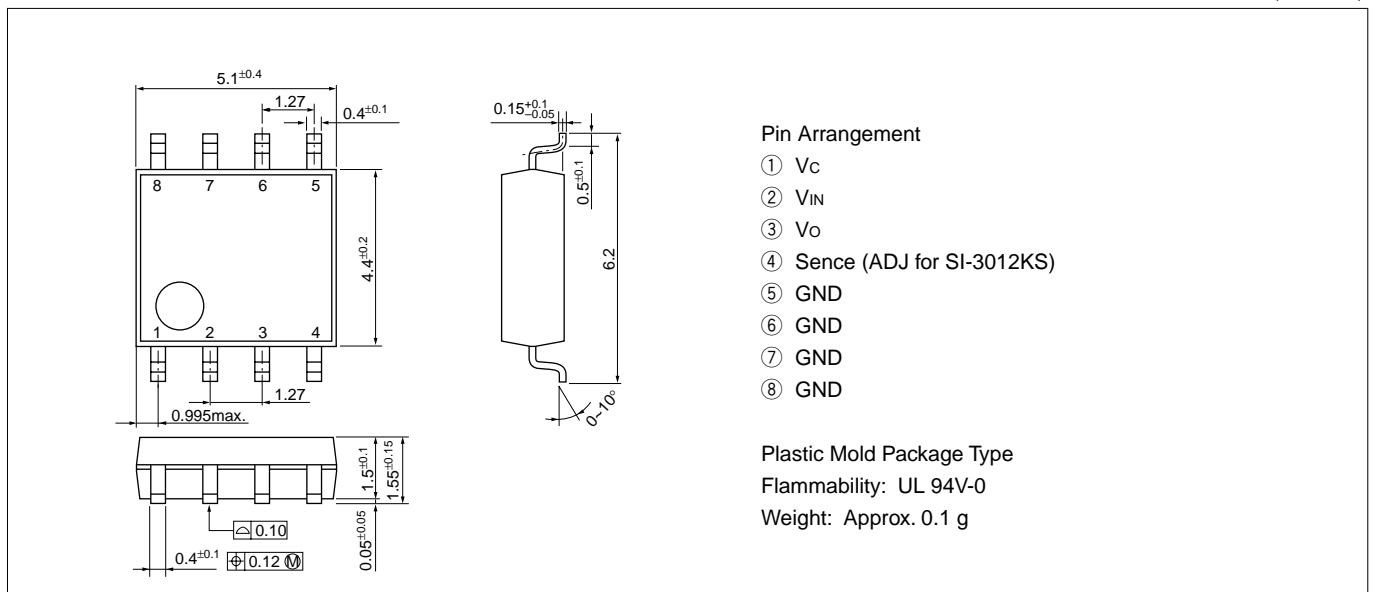

■Block Diagram

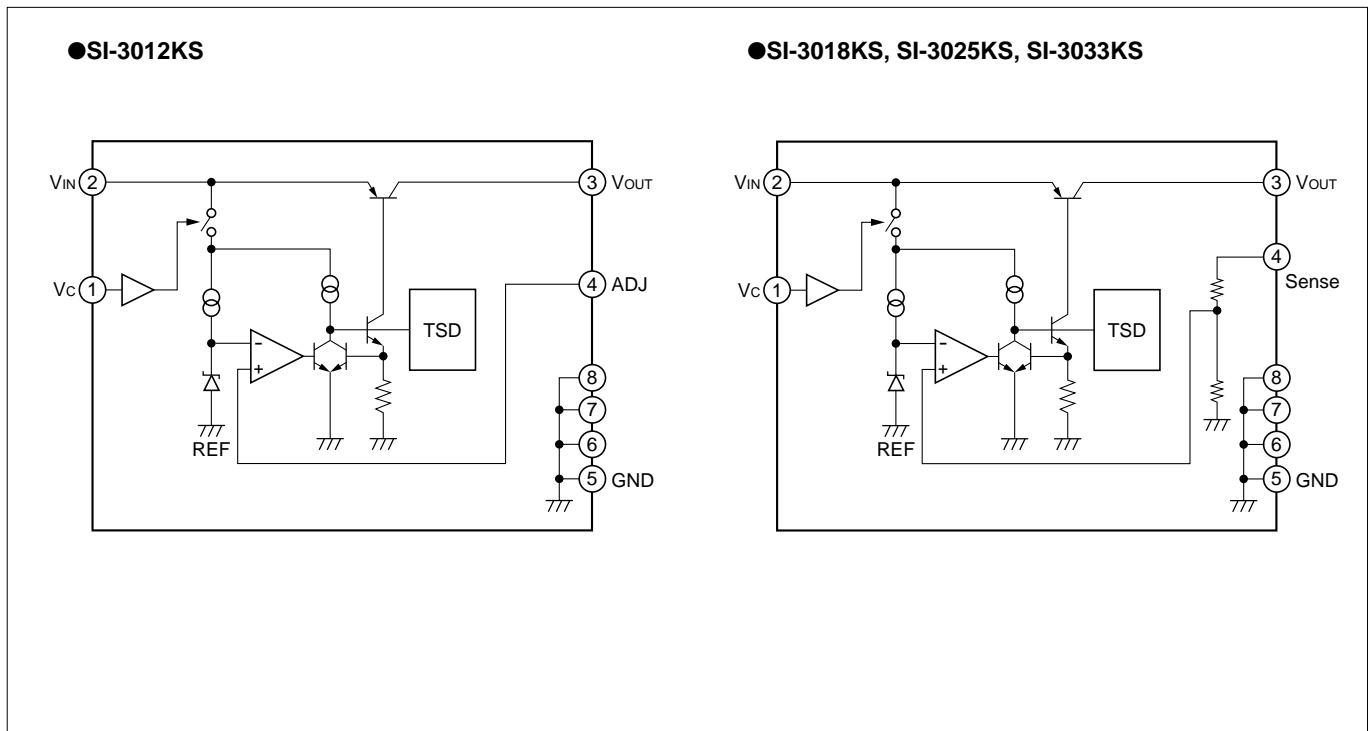

■Standard Circuit Connection Diagram

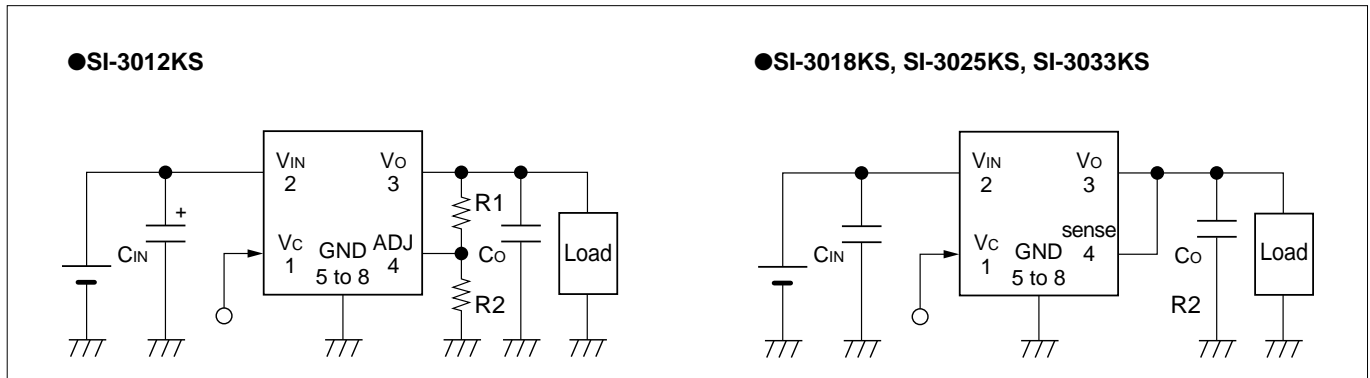

R₁, R₂: Output voltage setting resistors
 The output voltage can be set by connecting R₁ and R₂ as shown above.
 The recommended value of R₂ is 24 kΩ.

$$R_1 = (V_O - V_{ADJ}) \div (V_{ADJ} / R_2)$$

- C_{IN} : Input capacitor (22 μF or larger)
 This capacitor is necessary if an inductance is included in the input line or if the wiring length is long.
- C_O : Output capacitor (22 μF or larger)
 The SI-3000KS series designed for use with very low-ESR ceramics output capacitor.
 When using the electrolytic capacitor, the SI-3000KS series may oscillate at a low temperature.

Example of Solder Pattern Design

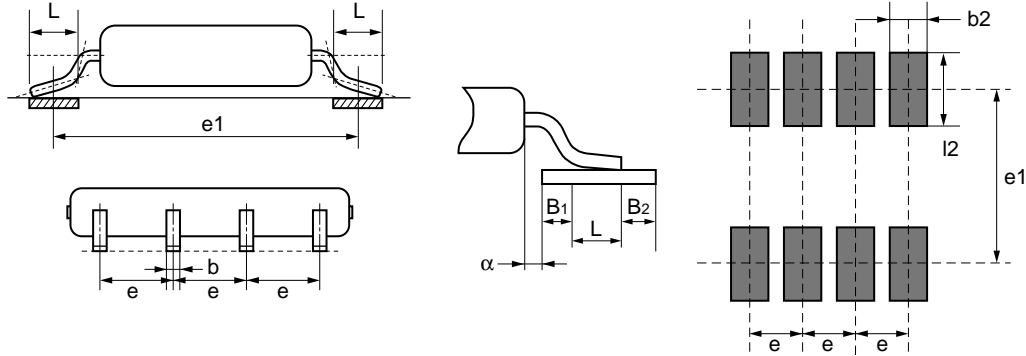

Symbol	Dimensions (mm)
e1	5.72
e	1.27±0.15
α	0.2
β1	0.2 to 0.5
β2	0.2
L	0.6
b2	0.76
l2	L+β1+β2

(Reference value conforming to EIAJ Standard ED-7402-1)

*1 The inner frame stage on which a monolithic IC is mounted is directly connected to the GND pins (pins 5 through 8). By expanding the area of the copper connected to the GND pins, the heat radiation can be improved. It is recommended to design the solder pattern by opening the insulation film of the solder patterns of pins 5, 6, 7, and 8, on the wide GND pattern as shown in Figure 1.

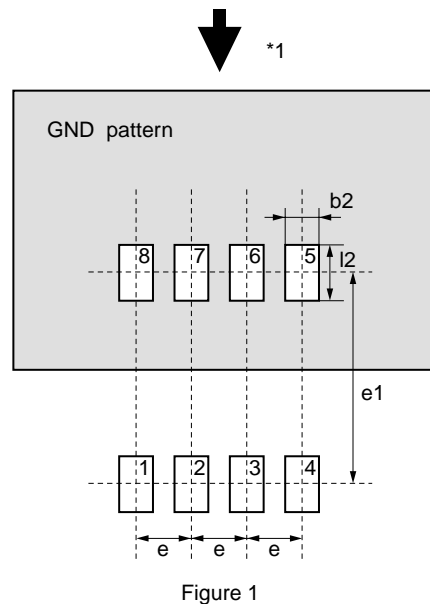
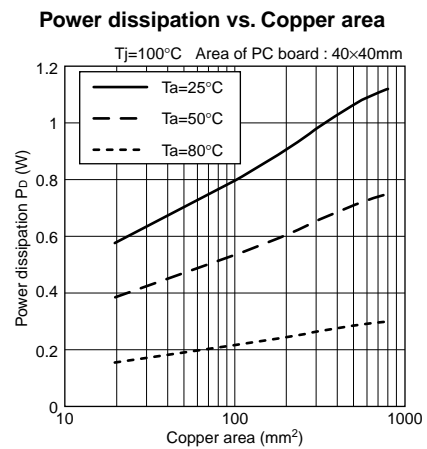
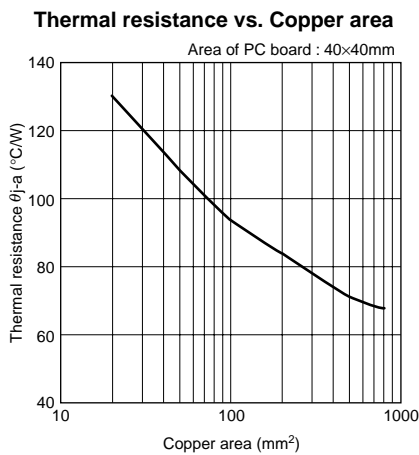

Figure 1

Reference Data



- Calculating junction temperature

Measure the temperature T_L of the lead of the GND pin (pin 7) by using a thermocouple, and substitute the measured value into the following expression to calculate the junction temperature.

$$T_j = P_D \times \theta_{j-L} + T_L \quad (\theta_{j-L} = 22^\circ \text{C/W})$$

■ Typical Characteristics Examples of SI-3012KS and SI-3025KS

($T_a=25^\circ\text{C}$) * $V_{out}=2.5\text{ V}$ for SI-3012KS ($R_S=24\text{ k}\Omega$)

Dropout voltage

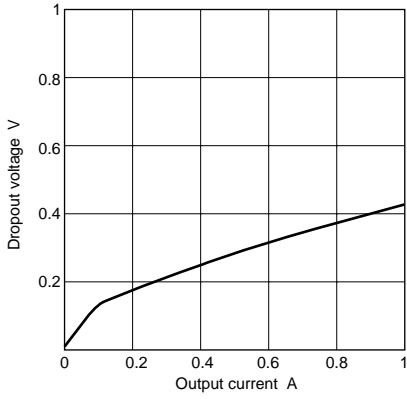

Rise characteristics

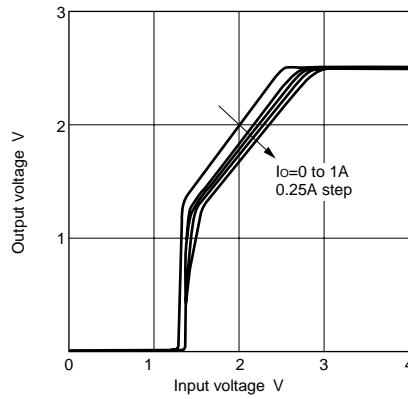

Line regulation

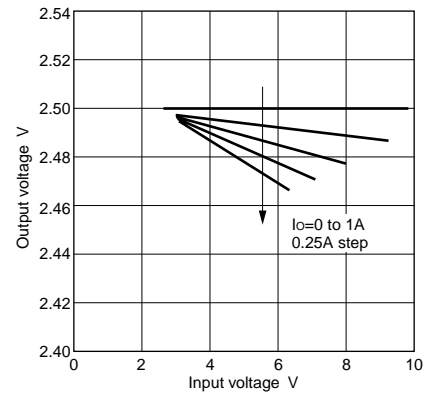

Load regulation

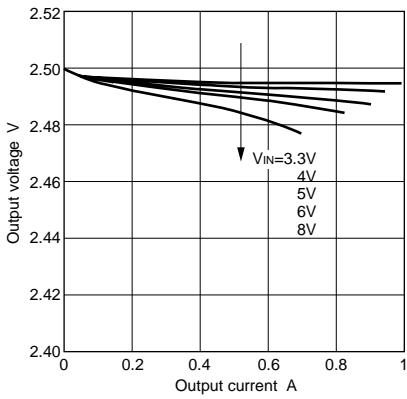

Overcurrent protection characteristics

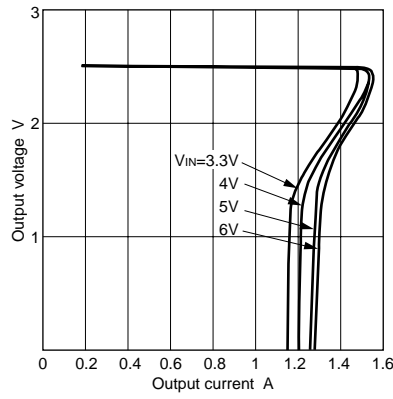

Input voltage vs. Quiescent current

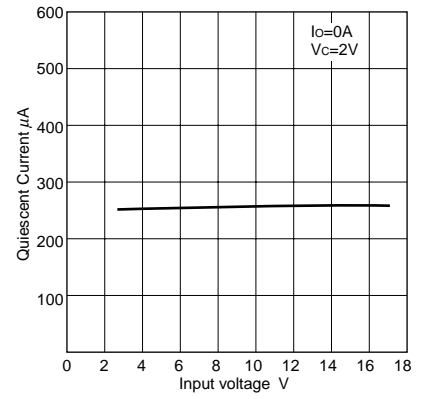

Circuit current

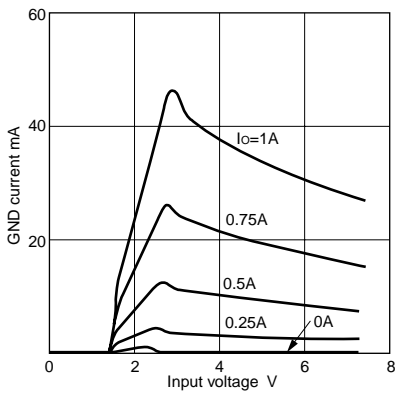

Control terminal voltage vs. Output voltage

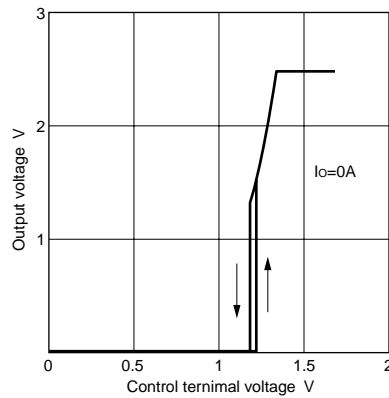

Control terminal voltage vs. Control terminal current

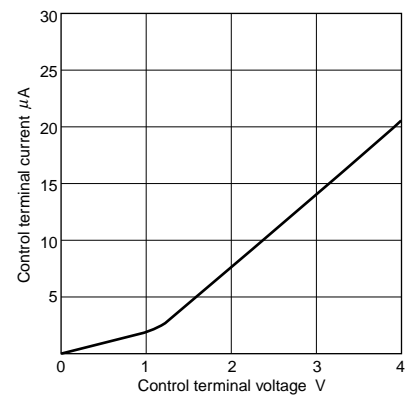

■ Typical Characteristics Examples of SI-3033KS

($T_a=25^\circ\text{C}$)

Dropout voltage

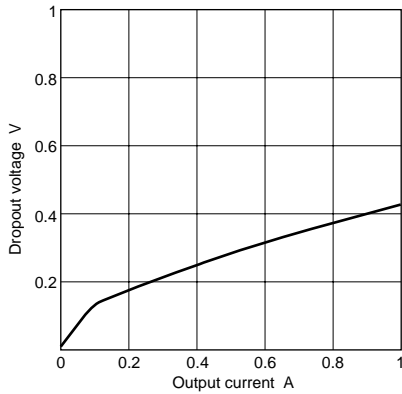

Rise characteristics

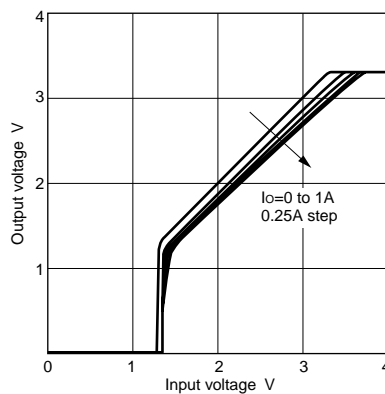

Line regulation

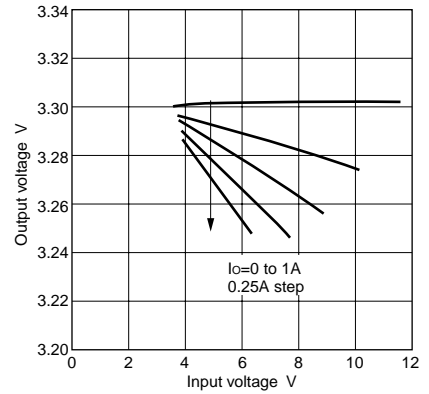

Load regulation

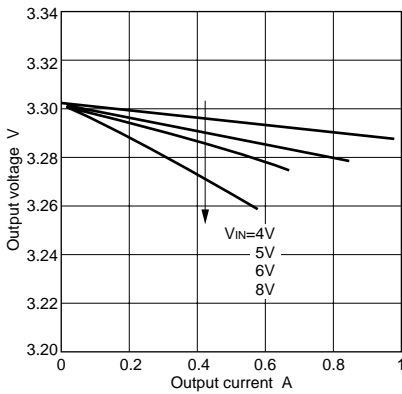

Overcurrent protection characteristics

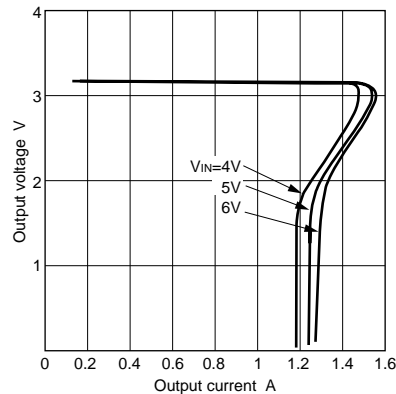

Input voltage vs. Quiescent current

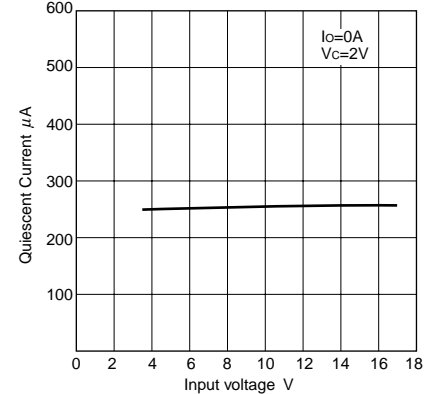

Circuit current

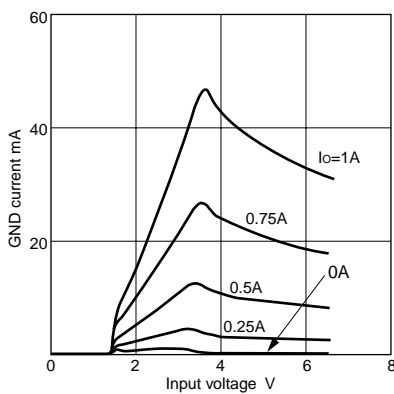

Control terminal voltage vs. Output voltage

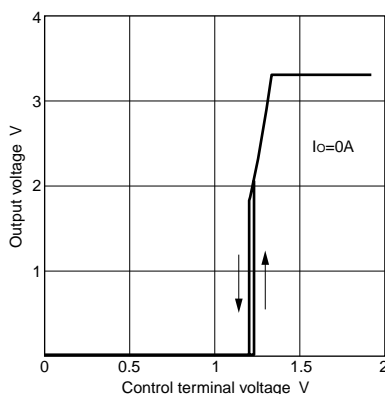

Control terminal voltage vs. Control terminal current

