

## SI-3000F Series

# 5-Terminal, Multi-Function, Full-Mold, Low Dropout Voltage Dropper Type

### Features

- Compact full-mold package (equivalent to TO220)
- Output current: 1.0A
- Low dropout voltage:  $V_{DI} \leq 1V$  (at  $I_o = 1.0A$ )
- Variable output voltage (rise only)  
May be used for remote sensing (excluding SI-3025F)
- Output ON/OFF control terminal is compatible with LS-TTL. (It may be directly driven by LS-TTL or standard CMOS logic.)
- Built-in foldback overcurrent, overvoltage, thermal protection circuits
- Variable output voltage type (SI-3025F) also available



### Applications

- For stabilization of the secondary stage of switching power supplies
- Electronic equipment

### Absolute Maximum Ratings

( $T_a = 25^\circ C$ )

Parameter	Symbol	Ratings					Unit
		SI-3050F	SI-3090F/3120F	SI-3150F/3157F	SI-3240F	SI-3025F	
DC Input Voltage	$V_{IN}$	25	30	35	45	30	V
Voltage of Output Control Terminal	$V_C$	$V_{IN}$					V
DC Output Current	$I_o$	$1.0^2$					A
Power Dissipation	$P_{D1}$	14(With infinite heatsink)					W
	$P_{D2}$	1.5(Without heatsink, stand-alone operation)					W
Junction Temperature	$T_j$	-40 to +125					$^\circ C$
Ambient Operating Temperature	$T_{op}$	-30 to +100					$^\circ C$
Storage Temperature	$T_{stg}$	-40 to +125					$^\circ C$
Thermal Resistance (junction to case)	$R_{th(j-c)}$	7.0					$^\circ C/W$
Thermal Resistance (junction to ambient air)	$R_{th(j-a)}$	66.7(Without heatsink, stand-alone operation)					$^\circ C/W$

■Electrical Characteristics (excluding SI-3025F)

(T<sub>a</sub>=25°C unless otherwise specified)

Parameter	Symbol	Ratings																		Unit	
		SI-3050F			SI-3090F			SI-3120F			SI-3150F			SI-3157F			SI-3240F				
		min.	typ.	max.	min.	typ.	max.	min.	typ.	max.	min.	typ.	max.	min.	typ.	max.	min.	typ.	max.		
Input Voltage	V <sub>IN</sub>	6 <sup>3</sup>		15 <sup>2</sup>	10 <sup>3</sup>		20 <sup>2</sup>	13 <sup>3</sup>		25 <sup>2</sup>	16 <sup>3</sup>		27 <sup>2</sup>	16.7 <sup>3</sup>		27 <sup>2</sup>	25 <sup>3</sup>		40	V	
Output Voltage	SI-3000F <sup>*1</sup>	4.80	5.00	5.20	8.64	9.00	9.36	11.52	12.00	12.48	14.40	15.00	15.60	14.92	15.70	16.48	23.04	24.00	24.96	V	
	SI-3000FA	4.90	5.00	5.10	8.82	9.00	9.18	11.76	12.00	12.24	14.70	15.00	15.30								
Dropout Voltage	Conditions	V <sub>IN</sub> =8V, I <sub>O</sub> =0.5A			V <sub>IN</sub> =12V, I <sub>O</sub> =0.5A			V <sub>IN</sub> =15V, I <sub>O</sub> =0.5A			V <sub>IN</sub> =18V, I <sub>O</sub> =0.5A			V <sub>IN</sub> =19V, I <sub>O</sub> =0.5A			V <sub>IN</sub> =27V, I <sub>O</sub> =0.5A			V	
	V <sub>DIF</sub>			0.5			0.5			0.5			0.5			0.5			0.5		
	Conditions	I <sub>O</sub> ≤0.5A																			
Line Regulation	Conditions	I <sub>O</sub> ≤1.0A																		mV	
	Conditions	I <sub>O</sub> ≤1.0A																			
	Conditions	I <sub>O</sub> ≤1.0A																			
Load Regulation	ΔV <sub>OLINE</sub>		10	30		18	48		24	64		30	90		30	90		48	128	mV	
	Conditions	V <sub>IN</sub> =6V to 15V, I <sub>O</sub> =0.5A			V <sub>IN</sub> =10V to 20V, I <sub>O</sub> =0.5A			V <sub>IN</sub> =13V to 25V, I <sub>O</sub> =0.5A			V <sub>IN</sub> =16V to 27V, I <sub>O</sub> =0.5A			V <sub>IN</sub> =17V to 27V, I <sub>O</sub> =0.5A			V <sub>IN</sub> =25V to 38V, I <sub>O</sub> =0.5A				
Temperature Coefficient of Output Voltage	ΔV <sub>OLOAD</sub>		40	100		70	180		93	240		120	300		120	300		120	300	mV/°C	
	Conditions	V <sub>IN</sub> =8V, I <sub>O</sub> =0 to 1.0A			V <sub>IN</sub> =12V, I <sub>O</sub> =0 to 1.0A			V <sub>IN</sub> =15V, I <sub>O</sub> =0 to 1.0A			V <sub>IN</sub> =18V, I <sub>O</sub> =0 to 1.0A			V <sub>IN</sub> =19V, I <sub>O</sub> =0 to 1.0A			V <sub>IN</sub> =27V, I <sub>O</sub> =0 to 1.0A				
Ripple Rejection	ΔV <sub>O/ΔT<sub>a</sub></sub>		±0.5			±1.0			±1.5			±1.5			±1.5			±2.5		mV/°C	
	Conditions	V <sub>IN</sub> =8V, I <sub>O</sub> =5mA, T <sub>J</sub> =0 to 100°C			V <sub>IN</sub> =12V, I <sub>O</sub> =5mA, T <sub>J</sub> =0 to 100°C			V <sub>IN</sub> =15V, I <sub>O</sub> =5mA, T <sub>J</sub> =0 to 100°C			V <sub>IN</sub> =18V, I <sub>O</sub> =5mA, T <sub>J</sub> =0 to 100°C			V <sub>IN</sub> =19V, I <sub>O</sub> =5mA, T <sub>J</sub> =0 to 100°C			V <sub>IN</sub> =27V, I <sub>O</sub> =5mA, T <sub>J</sub> =0 to 100°C				
Quiescent Circuit Current	R <sub>REJ</sub>		54			54			54			54			54			54		dB	
	Conditions	V <sub>IN</sub> =8V, f=100 to 120Hz			V <sub>IN</sub> =12V, f=100 to 120Hz			V <sub>IN</sub> =15V, f=100 to 120Hz			V <sub>IN</sub> =18V, f=100 to 120Hz			V <sub>IN</sub> =19V, f=100 to 120Hz			V <sub>IN</sub> =27V, f=100 to 120Hz				
Overcurrent Protection Starting Current <sup>*4,7</sup>	I <sub>q</sub>		3	10		3	10		3	10		3	10		3	10		5	10	mA	
	Conditions	V <sub>IN</sub> =8V, I <sub>O</sub> =0A			V <sub>IN</sub> =12V, I <sub>O</sub> =0A			V <sub>IN</sub> =15V, I <sub>O</sub> =0A			V <sub>IN</sub> =18V, I <sub>O</sub> =0A			V <sub>IN</sub> =19V, I <sub>O</sub> =0A			V <sub>IN</sub> =27V, I <sub>O</sub> =0A				
V <sub>C</sub> Terminal <sup>*5</sup>	I <sub>s1</sub>	1.2			1.2			1.2			1.2			1.2			1.2			A	
	Conditions	V <sub>IN</sub> =8V			V <sub>IN</sub> =12V			V <sub>IN</sub> =15V			V <sub>IN</sub> =18V			V <sub>IN</sub> =19V			V <sub>IN</sub> =27V				
	Control Voltage (Output ON)	V <sub>C IH</sub>	2.0			2.0			2.0			2.0			2.0			2.0			V
	Control Voltage (Output OFF)	V <sub>C IL</sub>			0.8			0.8			0.8			0.8			0.8			0.8	
	Control Current (Output ON)	I <sub>C IH</sub>			20			20			20			20			20			20	μA
	Conditions	V <sub>C</sub> =2.7V																			
Control Current (Output OFF)	I <sub>C IL</sub>			-0.3			-0.3			-0.3			-0.3			-0.3			-0.3	mA	
Conditions	V <sub>C</sub> =0.4V																				

\*1: "A" may be indicated to the right of the Sanken logo.

\*2: V<sub>IN(max)</sub> and I<sub>O(max)</sub> are restricted by the relation P<sub>D(max)</sub>=(V<sub>IN</sub>-V<sub>O</sub>)•I<sub>O</sub>=14(W).

\*3: Refer to the dropout voltage.(Refer to Setting DC Input Voltage on page 7.)

\*4: I<sub>s1</sub> is specified at -5(%) drop point of output voltage V<sub>O</sub> on the condition that V<sub>IN</sub>=V<sub>O</sub>+3V, I<sub>O</sub>=0.5A.

\*5: Output is ON even when output control terminal VC is open. Each input level is equivalent to LS-TTL. Therefore, it may be directly driven by an LS-TTL circuit.

\*6: When setting output voltage to 5V or less, input voltage needs to be set to 6V or over to operate stably.

\*7: A foldback type overcurrent protection circuit is built into the IC regulator. Therefore, avoid using it for the following applications as it may cause starting errors:

- (1) Constant current load (2) Plus/minus power (3) Series power (4) V<sub>O</sub> adjustment by raising ground voltage

■Electrical Characteristics (SI-3025F)

(Ta=25°C unless otherwise specified)

Parameter	Symbol	Ratings			Unit	
		SI-3025F				
		min.	typ.	max.		
Input Voltage	V <sub>IN</sub>	6 <sup>±6</sup>		25 <sup>±2</sup>	V	
Output Voltage	V <sub>O</sub>	3		24	V	
Reference Voltage	V <sub>REF</sub>	2.45	2.55	2.65	V	
Dropout Voltage	V <sub>DIF</sub>			0.5	V	
	Conditions	I <sub>o</sub> ≤0.5A				
	Conditions	I <sub>o</sub> ≤1.0A				
Line Regulation	ΔV <sub>OLINE</sub>			10	mV/V	
	Conditions	V <sub>IN</sub> =V <sub>O</sub> +1 to 25V, I <sub>o</sub> =0.5A				
Load Regulation	ΔV <sub>OLOAD</sub>			20	mV/V	
	Conditions	V <sub>IN</sub> =V <sub>O</sub> +3V, I <sub>o</sub> =0 to 1.0A				
Temperature Coefficient of Reference Voltage	ΔV <sub>REF</sub> /ΔT <sub>a</sub>		±0.5		mV/°C	
	Conditions	V <sub>IN</sub> =V <sub>O</sub> +3V, I <sub>o</sub> =5mA, T <sub>j</sub> =0 to 100°C				
Ripple Rejection	R <sub>REJ</sub>		54		dB	
	Conditions	V <sub>IN</sub> =V <sub>O</sub> +3V, f=100 to 120Hz				
Quiescent Circuit Current	I <sub>q</sub>		3	10	mA	
	Conditions	V <sub>IN</sub> =V <sub>O</sub> +3V, I <sub>o</sub> =0A				
Overcurrent Protection Starting Current <sup>4,7</sup>	I <sub>s1</sub>	1.2			A	
	Conditions	V <sub>IN</sub> =V <sub>O</sub> +3V				
V <sub>c</sub> Terminal <sup>5</sup>	Control Voltage (Output ON)	V <sub>c</sub> . IH	2.0		V	
	Control Voltage (Output OFF)	V <sub>c</sub> . IL		0.8		
	Control Current (Output ON)	I <sub>c</sub> . IH			20	μA
		Conditions	V <sub>c</sub> =2.7V			
	Control Current (Output OFF)	I <sub>c</sub> . IL			-0.3	mA
		Conditions	V <sub>c</sub> =0.4V			

■Outline Drawing

(unit:mm)

Top View Dimensions:  $\phi 3.2^{±0.2}$ ,  $10.0^{±0.2}$ ,  $0.5$ ,  $4.0^{±0.2}$ ,  $7.9^{±0.2}$ ,  $16.9^{±0.3}$ ,  $0.95^{±0.15}$ ,  $0.85^{+0.2}_{-0.1}$ ,  $P1.7^{±0.7} \times 4 = 6.8^{±0.7}$

Side View Dimensions:  $4.2^{±0.2}$ ,  $2.8^{±0.2}$ ,  $2.6^{±0.1}$ ,  $(17.9)$ ,  $5.0^{±0.6}$ ,  $(8.0)$ ,  $(4.6)$ ,  $0.45^{+0.2}_{-0.1}$ ,  $3.9^{±0.7}$ ,  $(4.3)$ ,  $8.2^{±0.7}$

Terminal View Dimensions: 1, 2, 3, 4, 5

Plastic Mold Package Type  
 Flammability: UL94V-0  
 Weight: Approx. 2.3g

Terminal Connections (Only SI-3025F)

① GND	① GND
② V <sub>c</sub>	② V <sub>c</sub>
③ V <sub>O</sub>	③ V <sub>O</sub>
④ V <sub>OS</sub>	④ V <sub>REF</sub>
⑤ V <sub>IN</sub>	⑤ V <sub>IN</sub>

Forming No. 1101

■Block Diagram

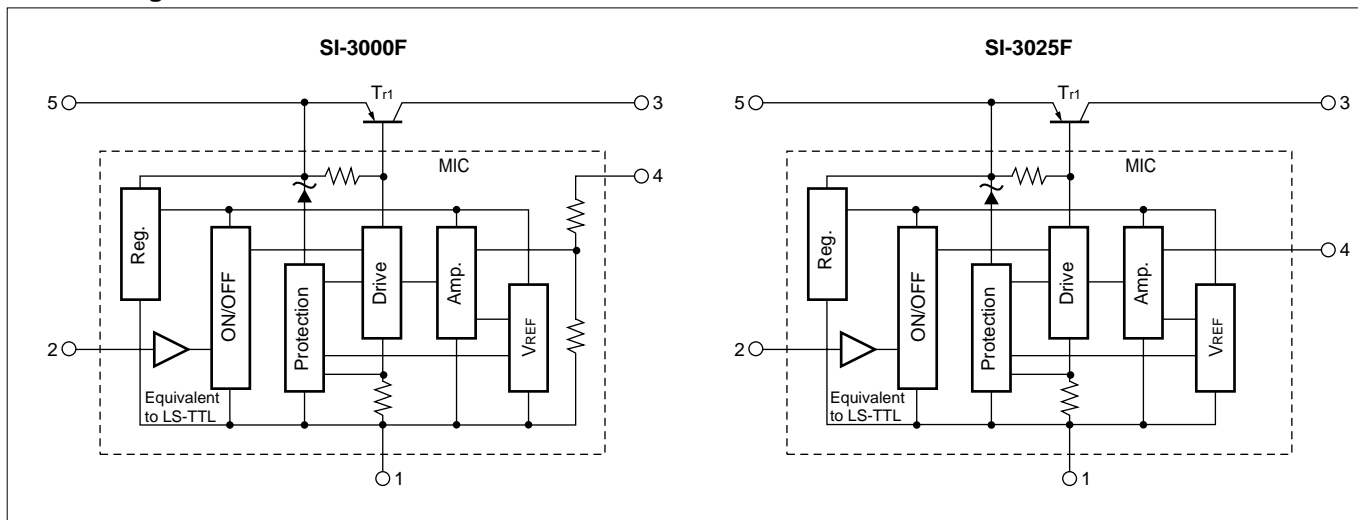

■Standard External Circuit

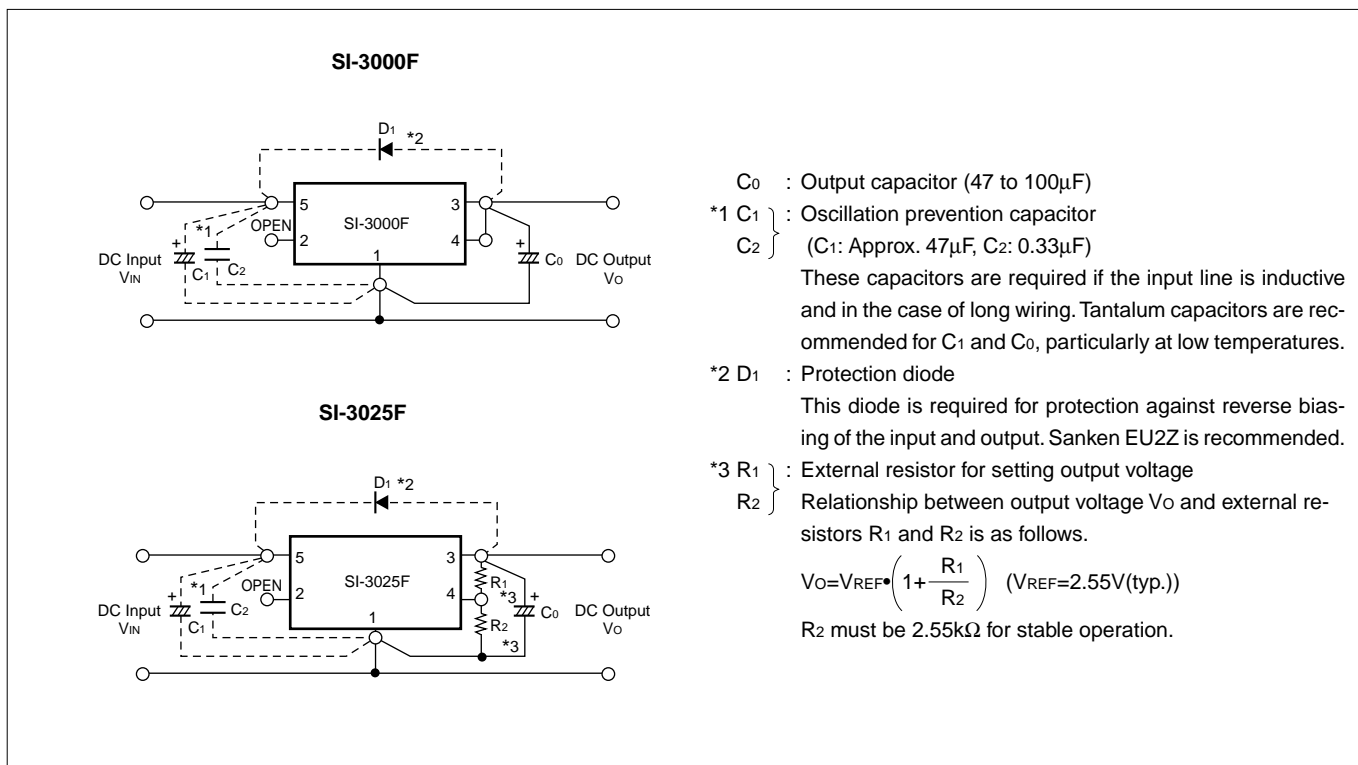

■ $T_a$ - $P_D$  Characteristics

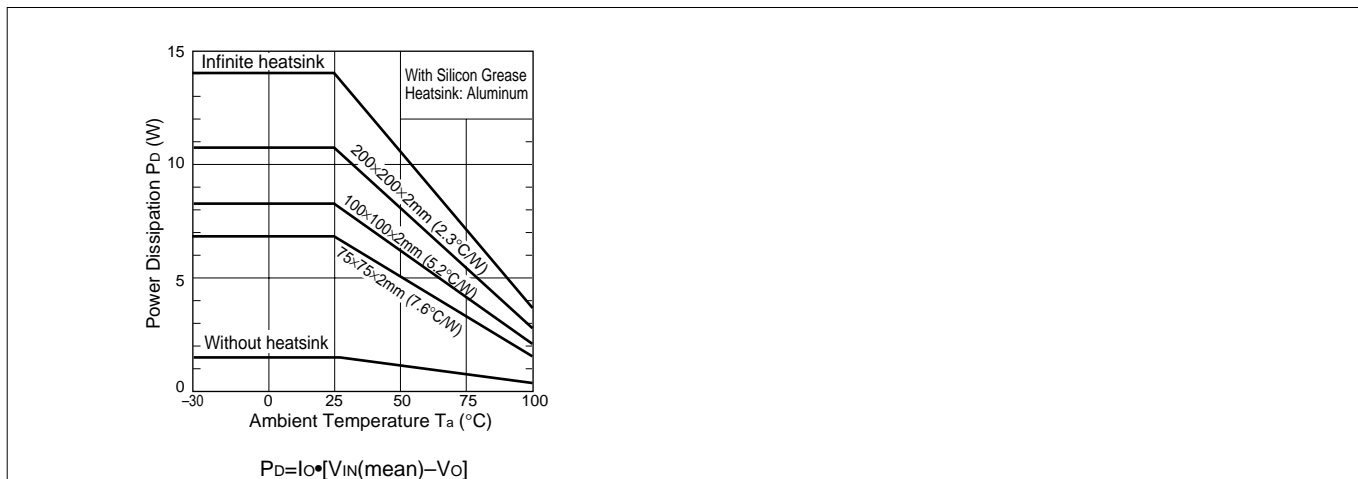

**External Variable Output Voltage Circuit (Excluding SI-3025F)**

**1. Variable output voltage with a single external resistor**

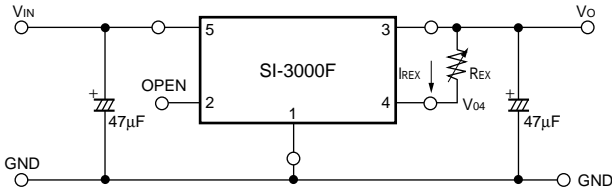

The output voltage may be increased by inserting resistor  $R_{EX}$  between terminals No.4 (sensing terminal) and No.3 (output terminal). The current  $I_{REX}$  flowing into terminal No.4 is 1mA (typ.), therefore the adjusted output voltage  $V_{OUT}$  is:

$$V_O = V_{04} + I_{REX} \cdot R_{EX} \quad *V_{04}: \text{output voltage of SI-3000F series}$$

However, the built-in resistor (between terminals No. 4 and No.1) is a semiconductor resistor, which has approximately thermal characteristics of  $+0.2\%/^{\circ}\text{C}$ .

It is important to keep the thermal characteristics in mind when adjusting the output voltage.

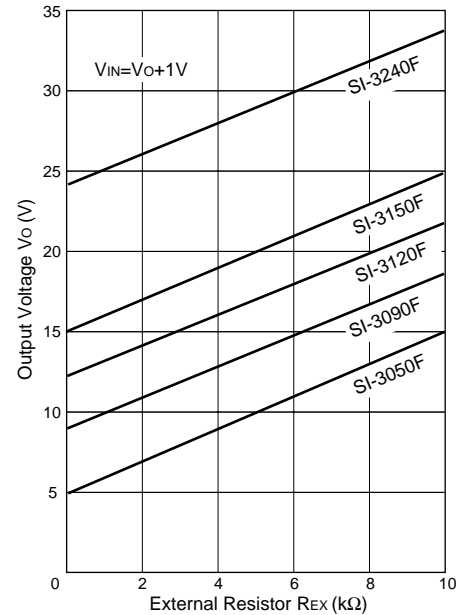

**2. Variable output voltage with two external resistors**

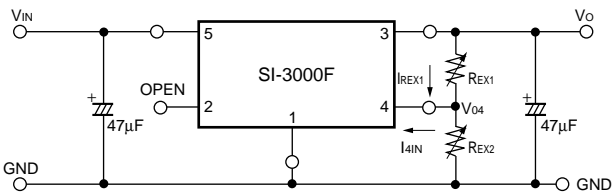

The output voltage may be increased by inserting resistors  $R_{EX1}$  between terminals No.4 (sensing terminal) and No.3 (output terminal) and  $R_{EX2}$  between terminals No.4 and No.1 (ground terminal).

The current  $I_{4IN}$  flowing into terminal No.4 is 1mA (typ.) so the thermal characteristics may be improved compared to the method shown in 1 by setting the external current  $I_{REX1}$  at approximately 5 times the value of  $I_{4IN}$  (stability coefficient  $S=5$ ).

The adjusted output voltage  $V_{OUT}$  in this case is:

$$\begin{cases} V_O = V_{04} + R_{EX1} \cdot I_{REX1} \\ I_{REX1} = S \cdot I_{4IN} \end{cases}$$

The value of the external resistors may be obtained as follows:

$$R_{EX1} = \frac{V_O - V_{04}}{S \cdot I_{4IN}}, \quad R_{EX2} = \frac{V_{04}}{(S-1) \cdot I_{4IN}}$$

\* $V_{04}$ : Output voltage of SI-3000F series

S: Stability coefficient of  $I_{4IN}$  (may be set to any value)

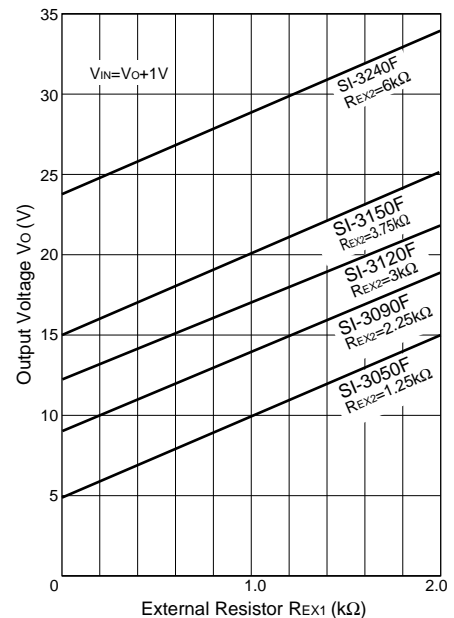

Note: In the SI-3000F series, the output voltage increase can be adjusted as mentioned above. However, when the rise is set to approximately 10V compared to output voltage  $V_{04}$ , the necessary output current may not be obtained due to the S.O.A. protection circuit in the SI-3000F series.

■Typical Characteristics

( $T_a=25^\circ\text{C}$ )

**$I_o$  vs.  $V_{DIF}$  Characteristics**

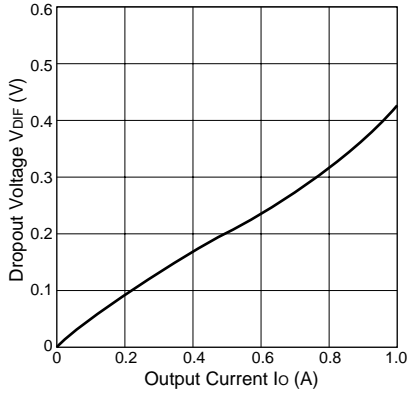

**Temperature Coefficient of Output Voltage(SI-3050F)**

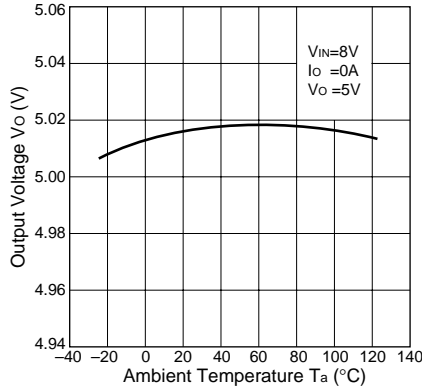

**Output ON/OFF Control(SI-3050F)**

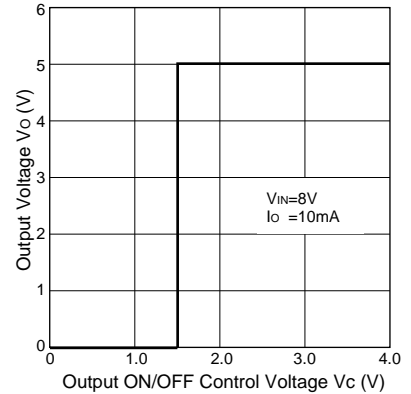

**Rise Characteristics(SI-3050F)**

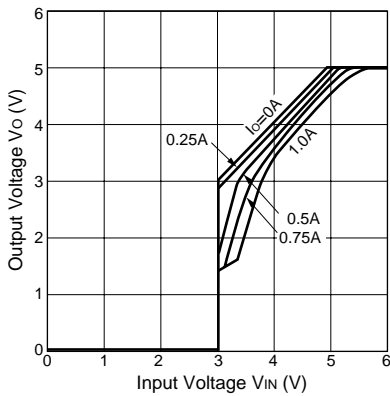

**Rise Characteristics(SI-3120F)**

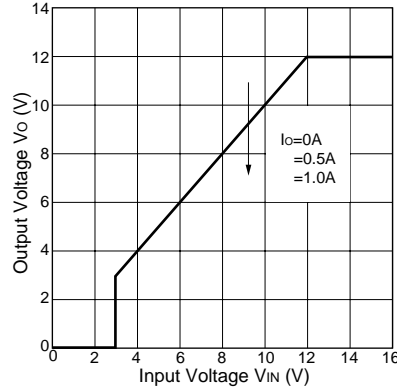

**Overcurrent Protection Characteristics(SI-3050F)**

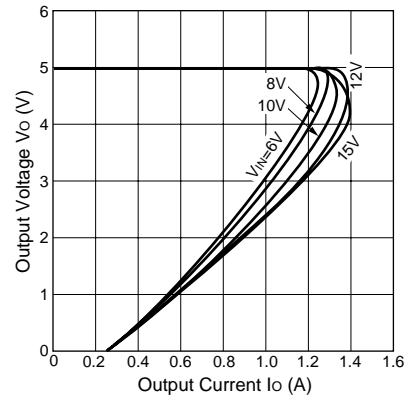

**Overcurrent Protection Characteristics(SI-3120F)**

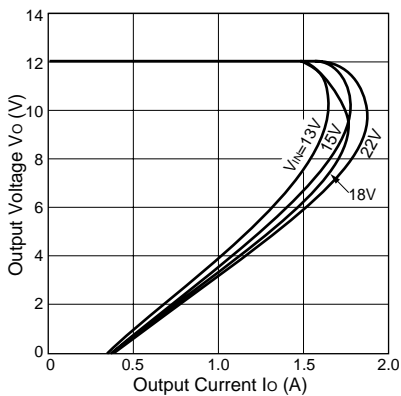

**Overcurrent Protection Characteristics(SI-3140F)**

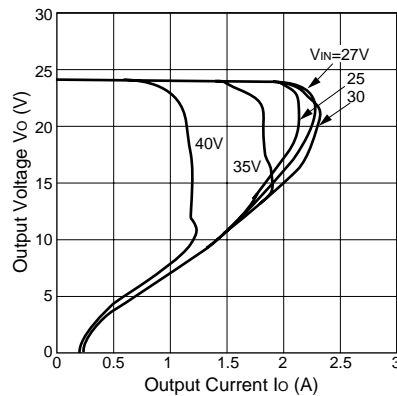

**Thermal Protection Characteristics(SI-3050F)**

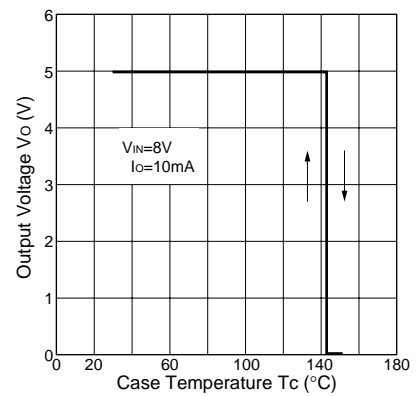

**Note on Thermal Protection:**

The thermal protection circuit is intended for protection against heat during instantaneous short-circuiting. Its operation is not guaranteed for short-circuiting over extended periods of time.