

## SI-8200L/8300L Series

# Self Oscillating Switching Type with Coil

### ■Features

- Integrated switching IC and coil construction
- Requires 2 external components only
- Low switching noise
- Heatsink not required

### ■Applications

- Telephone power supplies
- Onboard local power supplies

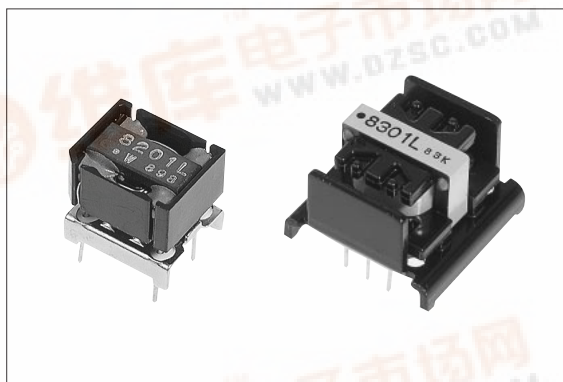

### ■Lineup

Part Number	SI-8201L	SI-8203L	SI-8211L	SI-8213L	SI-8301L
V <sub>o</sub> (V)	5	12	5	12	5
I <sub>o</sub> (A)	0.4	0.35	0.3	0.28	1.0

### ■Absolute Maximum Ratings

Parameter	Symbol	Ratings			Unit
		SI-8201L/8203L	SI-8211L/8213L	SI-8301L	
DC Input Voltage	V <sub>IN</sub>	45	60	45	V
Power Dissipation	P <sub>D</sub>	1.5	1.17	3.0	W
Junction Temperature	T <sub>j</sub>	+100			°C
Storage Temperature	T <sub>stg</sub>	-25 to +85			°C

### ■Recommended Operating Conditions

Parameter	Symbol	Ratings					Unit
		SI-8201L	SI-8203L	SI-8211L	SI-8213L	SI-8301L	
DC Input Voltage Range	V <sub>IN</sub>	10 to 40	16 to 40	15 to 55	22 to 55	8 to 40	V
Output Current Range	I <sub>o</sub>	0 to 0.4	0 to 0.35	0 to 0.3	0 to 0.28	0 to 1.0	A
Operating Temperature Range	T <sub>op</sub>	-10 to +65				-10 to +85	°C

■Electrical Characteristics

(Ta=25°C)

Parameter	Symbol	Ratings															Unit
		SI-8201L			SI-8203L			SI-8211L			SI-8213L			SI-8301L			
		min.	typ.	max.	min.	typ.	max.	min.	typ.	max.	min.	typ.	max.	min.	typ.	max.	
Output Voltage	Vo	4.9	5.0	5.1	11.8	12.0	12.2	4.9	5.0	5.1	11.8	12.0	12.2	5.0	5.1	5.2	V
	Conditions	VIN=15V, Io=0.2A			VIN=25V, Io=0.2A			VIN=35V, Io=0.2A			VIN=38V, Io=0.2A			VIN=15V, Io=0.5A			
Efficiency	η		73			79			63			78			73		%
	Conditions	VIN=15V, Io=0.2A			VIN=25V, Io=0.2A			VIN=35V, Io=0.2A			VIN=38V, Io=0.2A			VIN=15V, Io=0.5A			
Switching Frequency	f	25			25			25			25				25		kHz
Line Regulation	ΔV <sub>LINE</sub>		15	60		15	60			60			60			50	mV
	Conditions	VIN=10 to 20V, Io=0.2A			VIN=16 to 34V, Io=0.2A			VIN=20 to 50V, Io=0.2A			VIN=22 to 50V, Io=0.2A			VIN=10 to 20V, Io=0.5A			
Load Regulation	ΔV <sub>LOAD</sub>		15	60		60	100			60			60			80	mV
	Conditions	VIN=15V, Io=0.02 to 0.25A			VIN=25V, Io=0.02 to 0.3A			VIN=35V, Io=0.02 to 0.3A			VIN=38V, Io=0.02 to 0.28A			VIN=15V, Io=0.3 to 0.7A			
Temperature Coefficient of Output Voltage	ΔVo/ΔTa			±1.5			±1.5			±1.5			±1.5			±1.5	mV/°C
Switching Ripple Voltage (C2=470μF)	ΔV <sub>r</sub>		30	60		60	100		30	60		50	100		45		mV <sub>p-p</sub>
	Conditions	VIN=25V, Io=0.3A			VIN=40V, Io=0.35A			VIN=48V, Io=0.3A			VIN=48V, Io=0.28A			VIN=15V, Io=0.5A			

■Outline Drawing

(unit: mm)

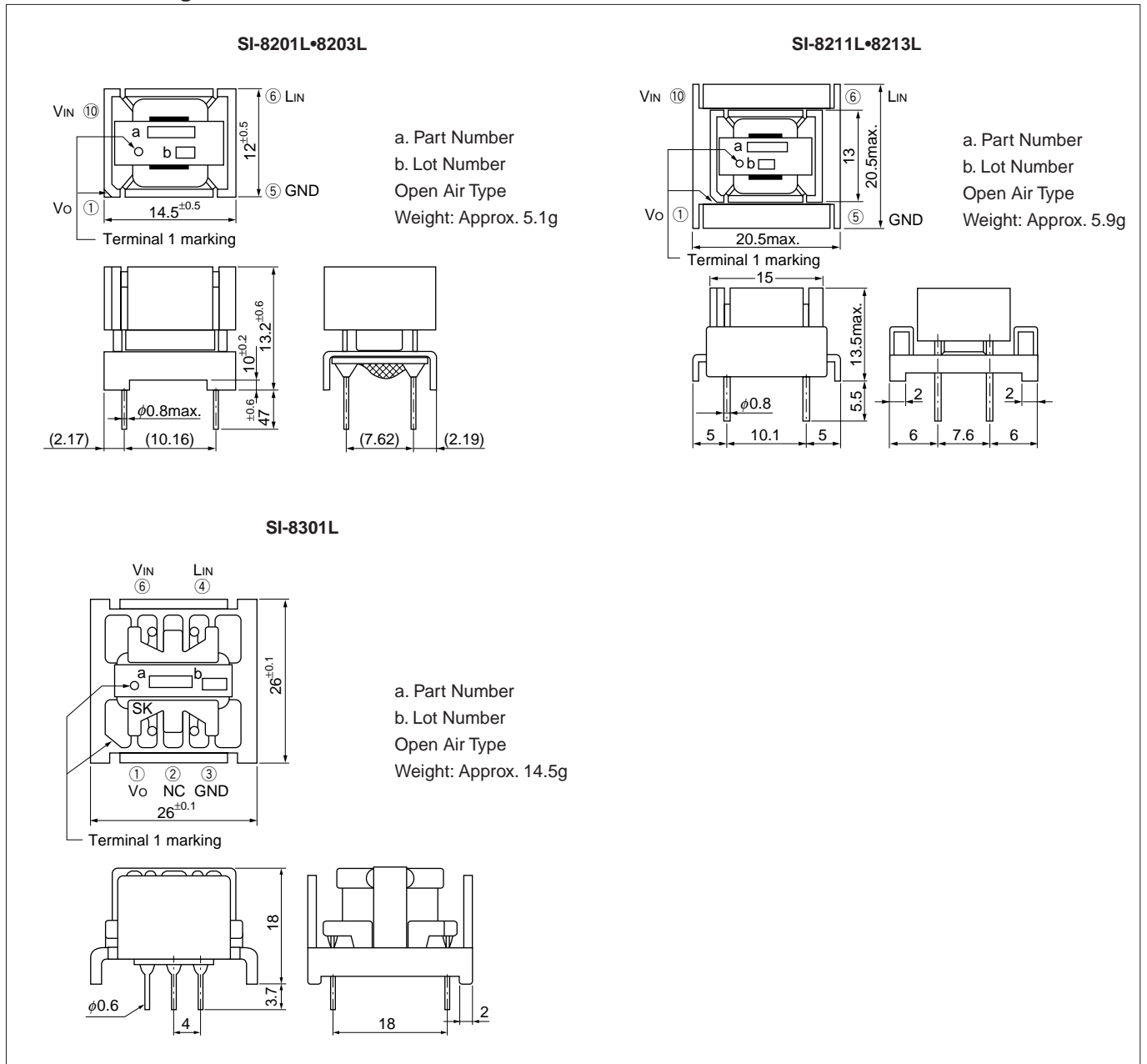

■Block Diagram

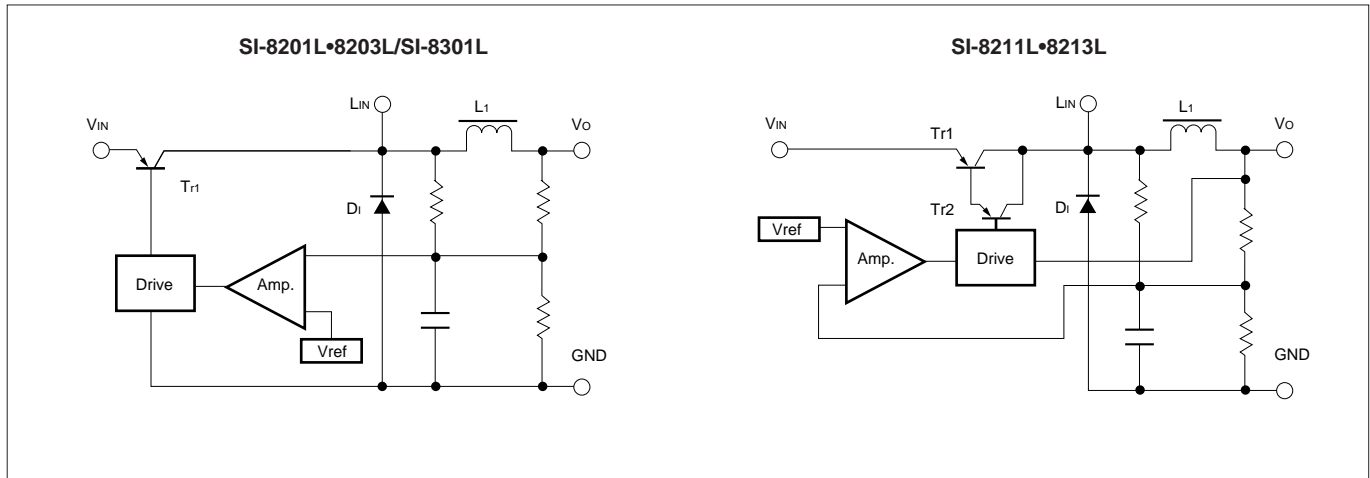

■Standard External Circuit

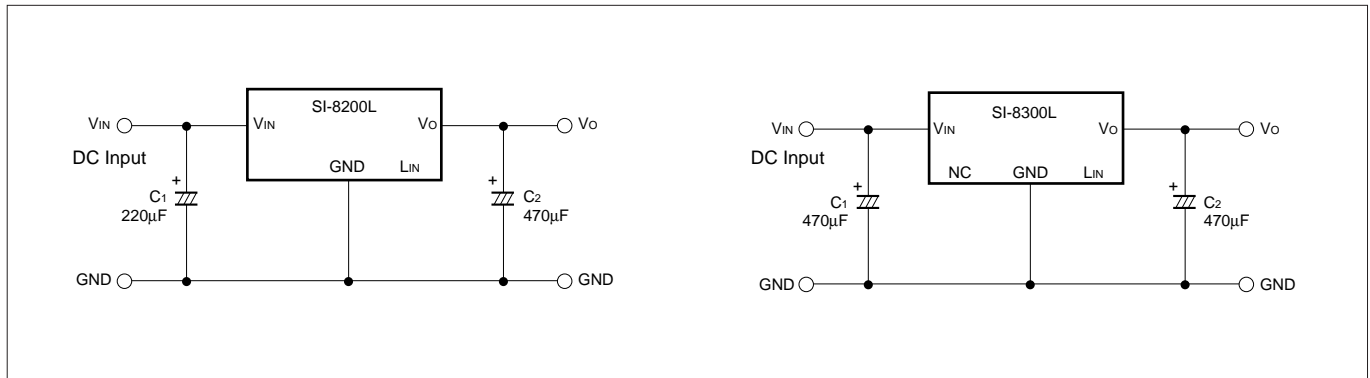

■Ta-Pd Characteristics

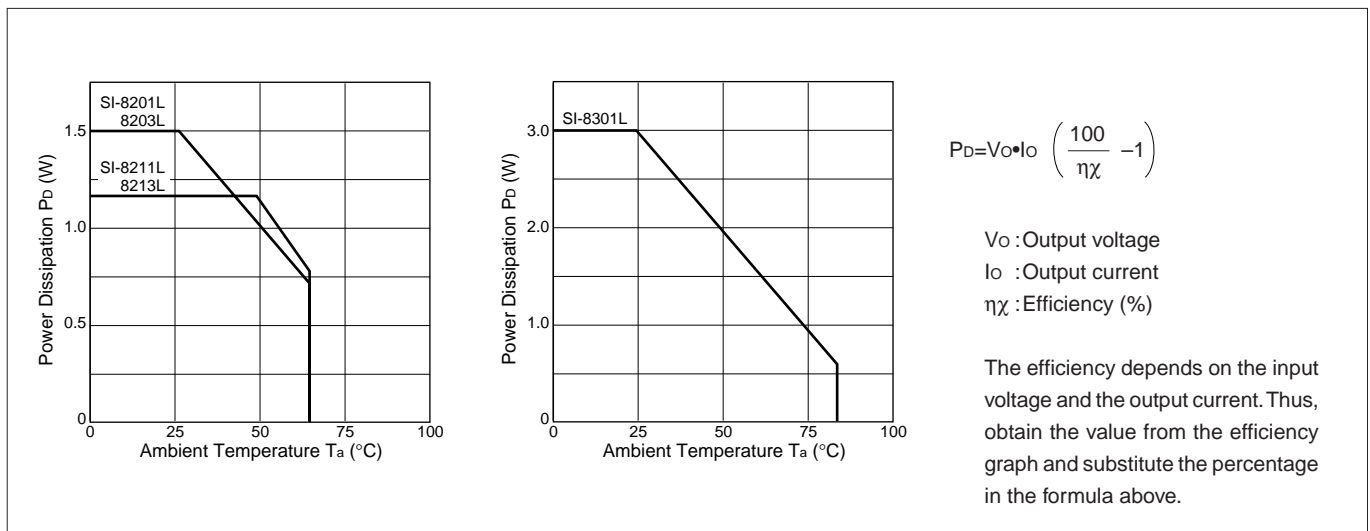

■Caution

1. A low-impedance capacitor suitable for switching applications must be used for the external capacitor and must be connected as close to the IC as possible in order to assure low ripple voltage and stable switching operation.
2. The SI-8200L and 8300L series do not have a built-in overcurrent protection circuit. Thus, avoid short-circuit conditions that may cause an overcurrent.
3. The SI-8300L series may not start up if the input voltage rises too rapidly.  
Do not use the SI-8300L series in applications where the input terminal, pin6, is opened and closed directly in a state where the input voltage is already applied.
4. Terminals LIN and NC in the connection diagram must be left unconnected to other circuits.
5. The IC's metallic heatsink is electrically floating. Do not connect it to GND or any other circuit.
6. Since the SI-8200L and 8300L series have an open-package construction, they can only be used in specific environments. Verify the operating environment and use the IC within the conditions indicated in the reliability data.

■Typical Characteristics

( $T_a=25^\circ\text{C}$ )

SI-8201L

Rise Characteristics

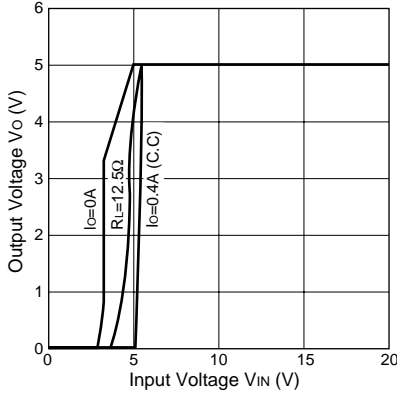

Efficiency Characteristics

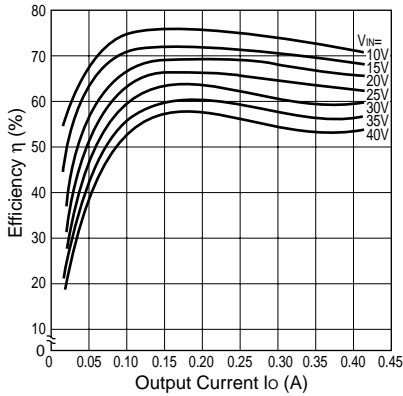

SI-8203L

Rise Characteristics

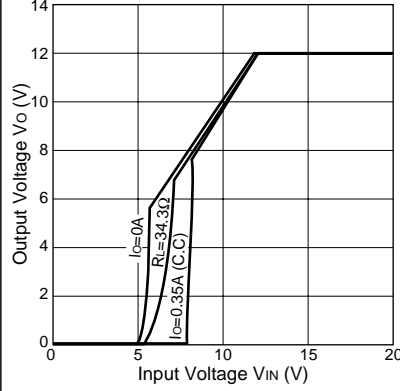

Efficiency Characteristics

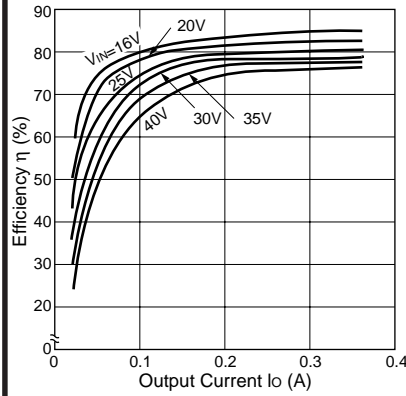

SI-8211L

Rise Characteristics

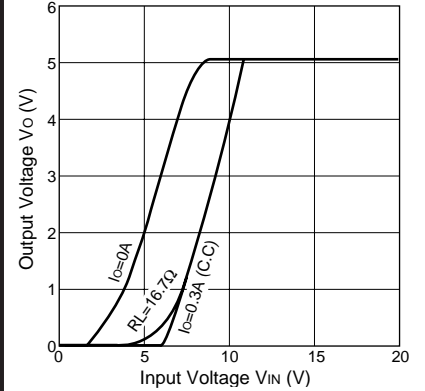

Efficiency Characteristics

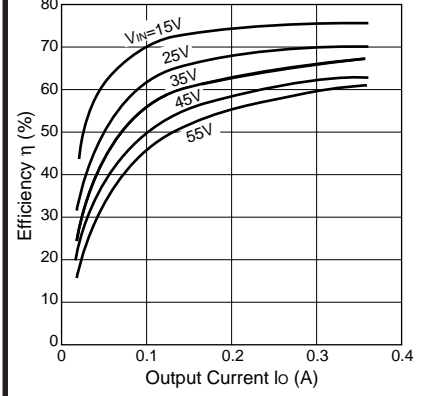

SI-8213L

Rise Characteristics

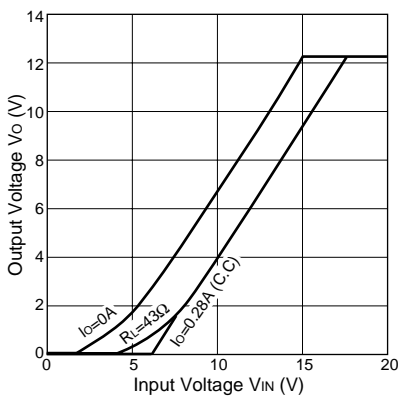

Efficiency Characteristics

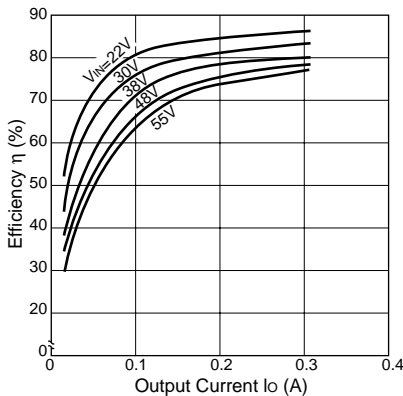

SI-8301L

Rise Characteristics

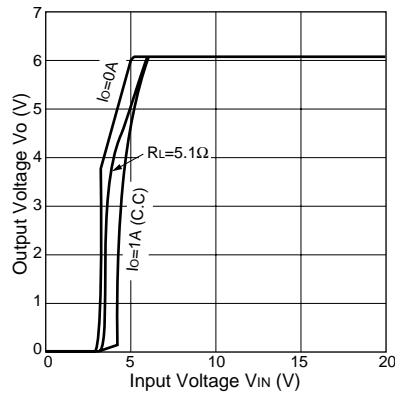

Efficiency Characteristics

