



New Product

Si1023X

Vishay Siliconix

Dual P-Channel 20-V (D-S) MOSFET

TrenchFET®
MOSFETs
1.8-V Rated



**ESD Protected
2000 V**

PRODUCT SUMMARY		
V _{DS} (V)	r _{DS(on)} (Ω)	I _D (mA)
-20	1.2 @ V _{GS} = -4.5 V	-350
	1.6 @ V _{GS} = -2.5 V	-300
	2.7 @ V _{GS} = -1.8 V	-150

FEATURES

- Very Small Footprint
- High-Side Switching
- Low On-Resistance: 1.2 Ω
- Low Threshold: 0.8 V (typ)
- Fast Switching Speed: 14 ns
- 1.8-V Operation
- Gate-Source ESD Protection

BENEFITS

- Ease in Driving Switches
- Low Offset (Error) Voltage
- Low-Voltage Operation
- High-Speed Circuits
- Low Battery Voltage Operation

APPLICATIONS

- Drivers: Relays, Solenoids, Lamps, Hammers, Displays, Memories
- Battery Operated Systems
- Power Supply Converter Circuits
- Load/Power Switching Cell Phones, Pagers

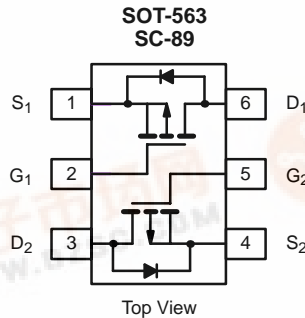

Marking Code: B

ABSOLUTE MAXIMUM RATINGS (T _A = 25°C UNLESS OTHERWISE NOTED)					
Parameter		Symbol	5 secs	Steady State	Unit
Drain-Source Voltage		V _{DS}	-20		V
Gate-Source Voltage		V _{GS}	±6		
Continuous Drain Current (T _J = 150°C) ^a	T _A = 25°C	I _D	-390	-370	mA
	T _A = 85°C		-280	-265	
Pulsed Drain Current ^b		I _{DM}	-650		
Continuous Source Current (diode conduction) ^a		I _S	-450	-380	
Maximum Power Dissipation ^a	T _A = 25°C	P _D	280	250	mW
	T _A = 85°C		145	130	
Operating Junction and Storage Temperature Range		T _J , T _{stg}	-55 to 150		°C
Gate-Source ESD Rating (HBM, Method 3015)		ESD	2000		V

Notes
^a Surface Mounted on FR4 Board.
^b Pulse width limited by maximum junction temperature.

SPECIFICATIONS (T _J = 25 °C UNLESS OTHERWISE NOTED)						
Parameter	Symbol	Test Condition	Min	Typ	Max	Unit
Static						
Gate Threshold Voltage	V _{GS(th)}	V _{DS} = V _{GS} , I _D = -250 μA	-0.45			V
Gate-Body Leakage	I _{GSS}	V _{DS} = 0 V, V _{GS} = ±4.5 V		±1	±2	μA
Zero Gate Voltage Drain Current	I _{DSS}	V _{DS} = -16 V, V _{GS} = 0 V		-0.3	-100	nA
		V _{DS} = -16 V, V _{GS} = 0 V, T _J = 85 °C			-5	μA
On-State Drain Current ^a	I _{D(on)}	V _{DS} = -5 V, V _{GS} = -4.5 V	-700			mA
Drain-Source On-State Resistance ^a	r _{DS(on)}	V _{GS} = -4.5 V, I _D = -350 mA		0.8	1.2	Ω
		V _{GS} = -2.5 V, I _D = -300 mA		1.2	1.6	
		V _{GS} = -1.8 V, I _D = -150 mA		1.8	2.7	
Forward Transconductance ^a	g _{fs}	V _{DS} = -10 V, I _D = -250 mA		0.4		S
Diode Forward Voltage ^a	V _{SD}	I _S = -150 mA, V _{GS} = 0 V		-0.8	-1.2	V
Dynamic^b						
Total Gate Charge	Q _g	V _{DS} = -10 V, V _{GS} = -4.5 V, I _D = -250 mA		1500		pC
Gate-Source Charge	Q _{gs}			150		
Gate-Drain Charge	Q _{gd}			450		
Turn-On Time	t _{ON}	V _{DD} = -10 V, R _L = 47 Ω I _D ≅ -200 mA, V _{GEN} = -4.5 V, R _G = 10 Ω		14		ns
Turn-Off Time	t _{OFF}			46		

Notes

- a. Pulse test; pulse width ≤ 300 μs, duty cycle ≤ 2%.
- b. Guaranteed by design, not subject to production testing.

TYPICAL CHARACTERISTICS (T_A = 25 °C UNLESS NOTED)

For the following graphs, p-channel negative polarities for all voltage and current values are represented as positive values.

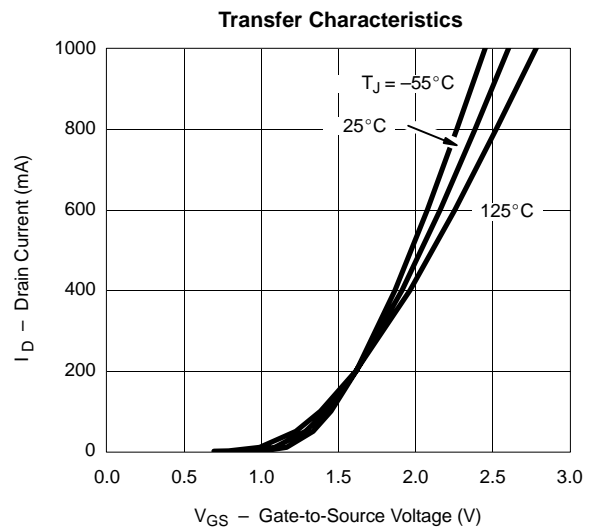
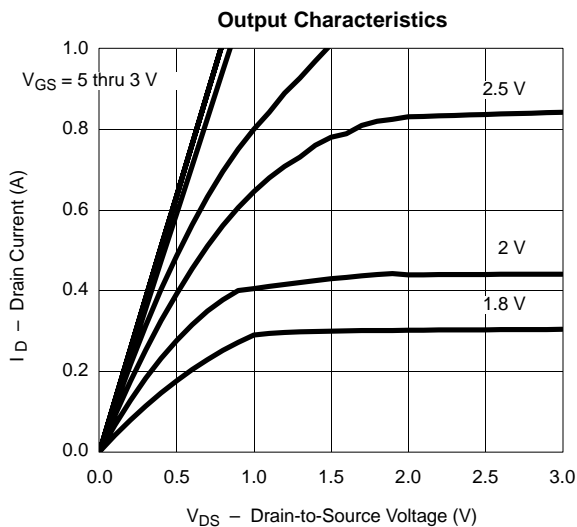



TYPICAL CHARACTERISTICS (T_A = 25 °C UNLESS NOTED)

On-Resistance vs. Drain Current

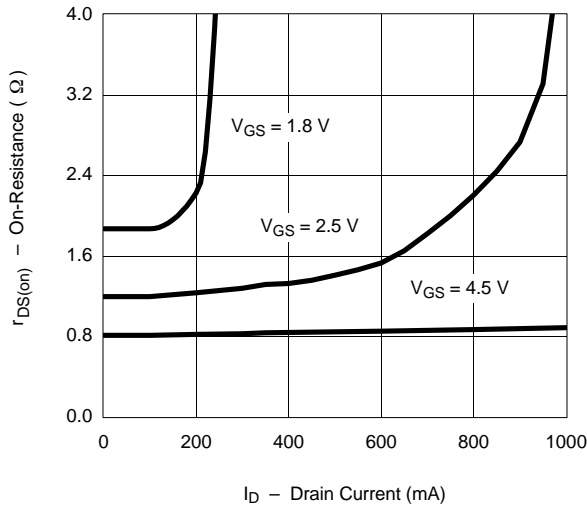

Capacitance

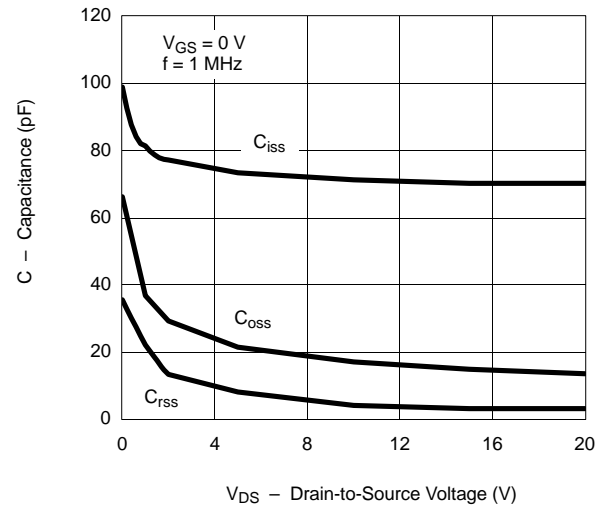

Gate Charge

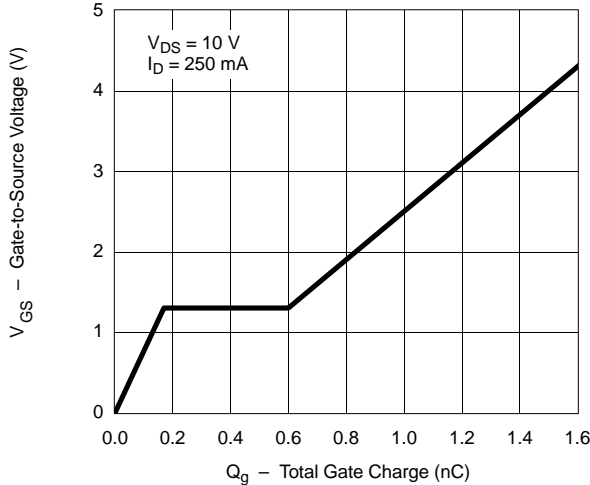

On-Resistance vs. Junction Temperature

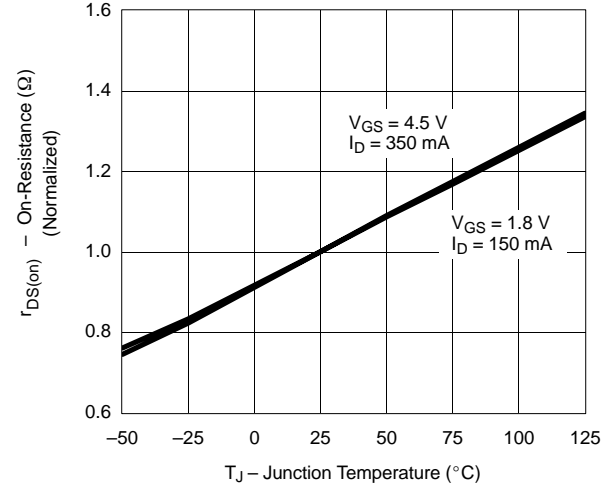

Source-Drain Diode Forward Voltage

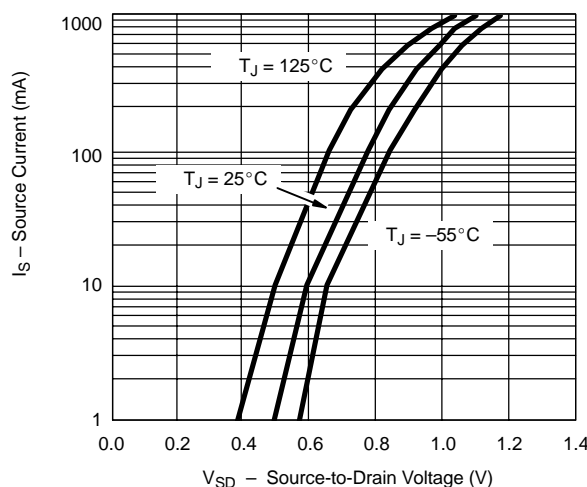

On-Resistance vs. Gate-to-Source Voltage

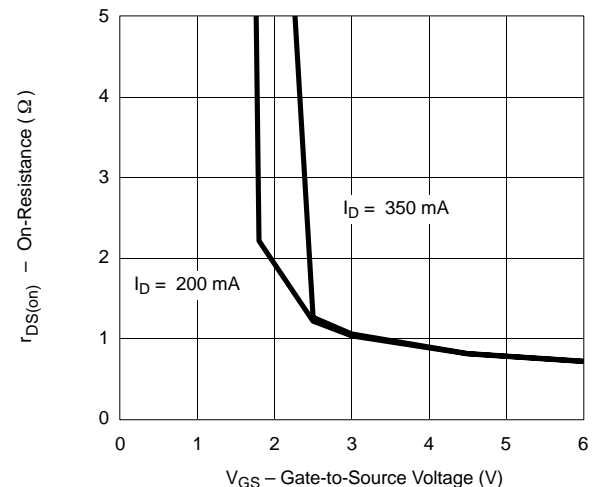

TYPICAL CHARACTERISTICS (T_A = 25°C UNLESS NOTED)

