



Si1553DL
Vishay Siliconix

Complementary 2.5-V (G-S) MOSFET

TrenchFET[®]
Power MOSFETs
2.5-V Rated

PRODUCT SUMMARY			
	V _{DS} (V)	r _{DS(on)} (Ω)	I _D (A)
N-Channel	20	0.385 @ V _{GS} = 4.5 V	± 0.70
		0.630 @ V _{GS} = 2.5 V	± 0.54
P-Channel	-20	0.995 @ V _{GS} = -4.5 V	± 0.44
		1.800 @ V _{GS} = -2.5 V	± 0.32

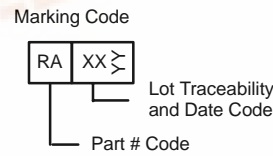
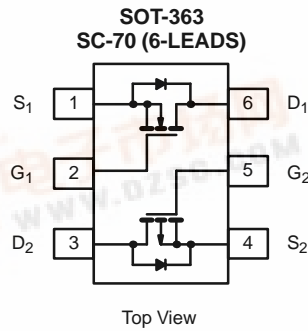

ABSOLUTE MAXIMUM RATINGS (T _A = 25 °C UNLESS OTHERWISE NOTED)							
Parameter	Symbol	N-Channel		P-Channel		Unit	
		5 secs	Steady State	5 secs	Steady State		
Drain-Source Voltage	V _{DS}	20		-20		V	
Gate-Source Voltage	V _{GS}	± 12					
Continuous Drain Current (T _J = 150 °C) ^a	I _D	T _A = 25 °C	± 0.70	± 0.66	± 0.44	± 0.41	A
		T _A = 85 °C	± 0.50	± 0.48	± 0.31	± 0.30	
Pulsed Drain Current	I _{DM}	± 1.0					
Continuous Source Current (Diode Conduction) ^a	I _S	0.25	0.23	-0.25	-0.23		
Maximum Power Dissipation ^a	P _D	T _A = 25 °C	0.30	0.27	0.30	0.27	W
		T _A = 85 °C	0.16	0.14	0.16	0.14	
Operating Junction and Storage Temperature Range	T _J , T _{stg}	-55 to 150				°C	

THERMAL RESISTANCE RATINGS					
Parameter		Symbol	Typical	Maximum	Unit
Maximum Junction-to-Ambient ^a	t ≤ 5 sec	R _{thJA}	360	415	°C/W
	Steady State		400	460	
Maximum Junction-to-Foot (Drain)	Steady State	R _{thJF}	300	350	

Notes:
a. Surface Mounted on 1" x 1" FR4 Board.

Si1553DL

Vishay Siliconix



SPECIFICATIONS (T _J = 25 °C UNLESS OTHERWISE NOTED)							
Parameter	Symbol	Test Condition		Min	Typ	Max	Unit
Static							
Gate Threshold Voltage	V _{GS(th)}	V _{DS} = V _{GS} , I _D = 250 μA	N-Ch	0.6			V
		V _{DS} = V _{GS} , I _D = -250 μA	P-Ch	-0.6			
Gate-Body Leakage	I _{GSS}	V _{DS} = 0 V, V _{GS} = ±12 V	N-Ch P-Ch			±100 ±100	nA
Zero Gate Voltage Drain Current	I _{DSS}	V _{DS} = 16 V, V _{GS} = 0 V	N-Ch			1	μA
		V _{DS} = -16 V, V _{GS} = 0 V	P-Ch			-1	
		V _{DS} = 16 V, V _{GS} = 0 V, T _J = 85 °C	N-Ch			5	
		V _{DS} = -16 V, V _{GS} = 0 V, T _J = 85 °C	P-Ch			-5	
On-State Drain Current ^a	I _{D(on)}	V _{DS} ≥ 5 V, V _{GS} = 4.5 V	N-Ch	1.0			A
		V _{DS} ≤ -5 V, V _{GS} = -4.5 V	P-Ch	-1.0			
Drain-Source On-State Resistance ^a	r _{DS(on)}	V _{GS} = 4.5 V, I _D = 0.66 A	N-Ch		0.320	0.385	Ω
		V _{GS} = -4.5 V, I _D = -0.41 A	P-Ch		0.850	0.995	
		V _{GS} = 2.5 V, I _D = 0.40 A	N-Ch		0.560	0.630	
		V _{GS} = -2.5 V, I _D = -0.25 A	P-Ch		1.4	1.800	
Forward Transconductance ^a	g _{fs}	V _{DS} = 10 V, I _D = 0.66 A	N-Ch		1.5		S
		V _{DS} = -10 V, I _D = -0.41 A	P-Ch		0.8		
Diode Forward Voltage ^a	V _{SD}	I _S = 0.23 A, V _{GS} = 0 V	N-Ch		0.8	1.2	V
		I _S = -0.23 A, V _{GS} = 0 V	P-Ch		-0.8	-1.2	
Dynamic^b							
Total Gate Charge	Q _g	N-Channel V _{DS} = 10 V, V _{GS} = 4.5 V, I _D = 0.66 A P-Channel V _{DS} = -10 V, V _{GS} = -4.5 V, I _D = -0.41 A	N-Ch		0.8	1.2	nC
Gate-Source Charge	Q _{gs}		N-Ch		0.06		
Gate-Drain Charge	Q _{gd}		P-Ch		0.45		
Turn-On Delay Time	t _{d(on)}	N-Channel V _{DD} = 10 V, R _L = 20 Ω I _D ≅ 0.5 A, V _{GEN} = 4.5 V, R _G = 6 Ω P-Channel V _{DD} = -10 V, R _L = 20 Ω I _D ≅ -0.5 A, V _{GEN} = -4.5 V, R _G = 6 Ω	N-Ch		10	20	ns
Rise Time	t _r		N-Ch		16	30	
			P-Ch		20	40	
Turn-Off Delay Time	t _{d(off)}		N-Ch		10	20	
			P-Ch		8.5	17	
Fall Time	t _f		N-Ch		10	20	
			P-Ch		12	24	
Source-Drain Reverse Recovery Time	t _{rr}		I _F = 0.23 A, di/dt = 100 A/μs	N-Ch		20	
		I _F = -0.23 A, di/dt = 100 A/μs	P-Ch		25	40	

Notes

- a. Pulse test; pulse width ≤ 300 μs, duty cycle ≤ 2%.
- b. Guaranteed by design, not subject to production testing.



TYPICAL CHARACTERISTICS (25°C UNLESS NOTED)

N-CHANNEL

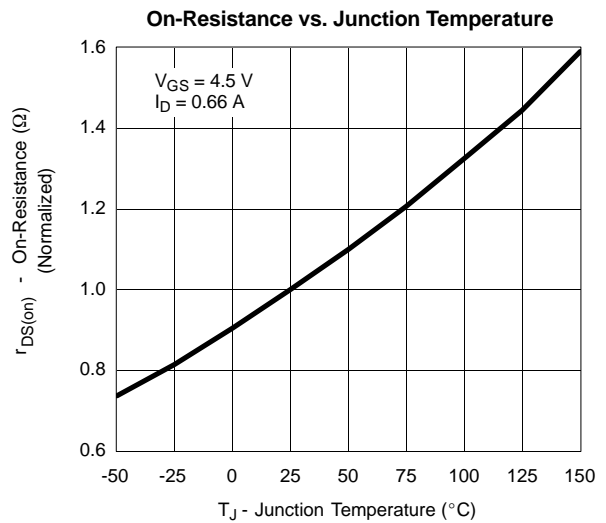
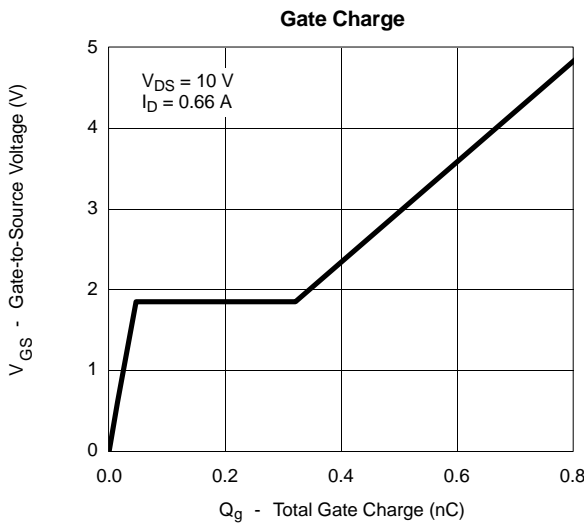
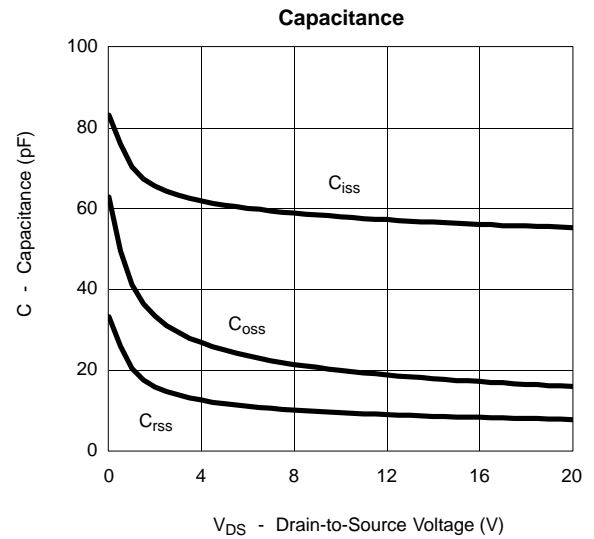
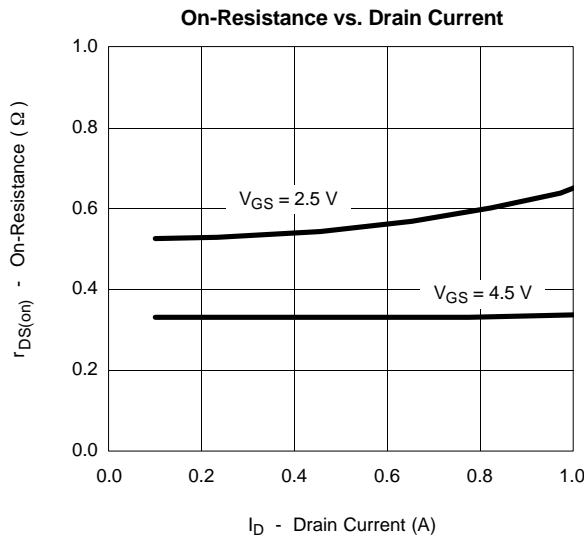
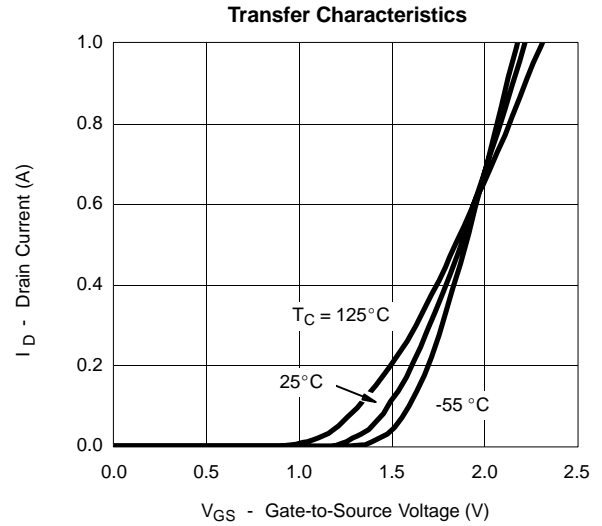
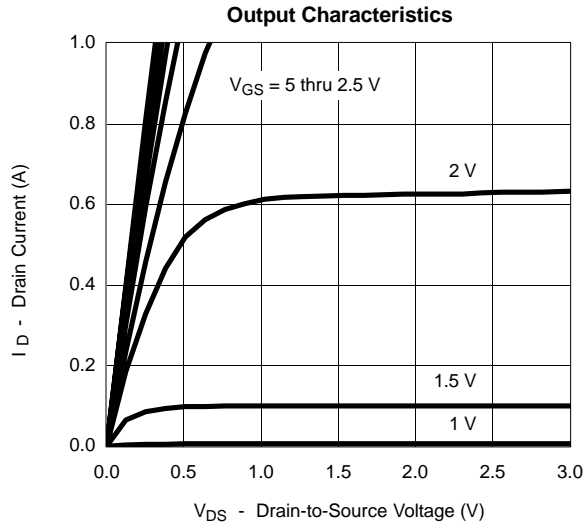



TYPICAL CHARACTERISTICS (25 °C UNLESS NOTED)

N-CHANNEL

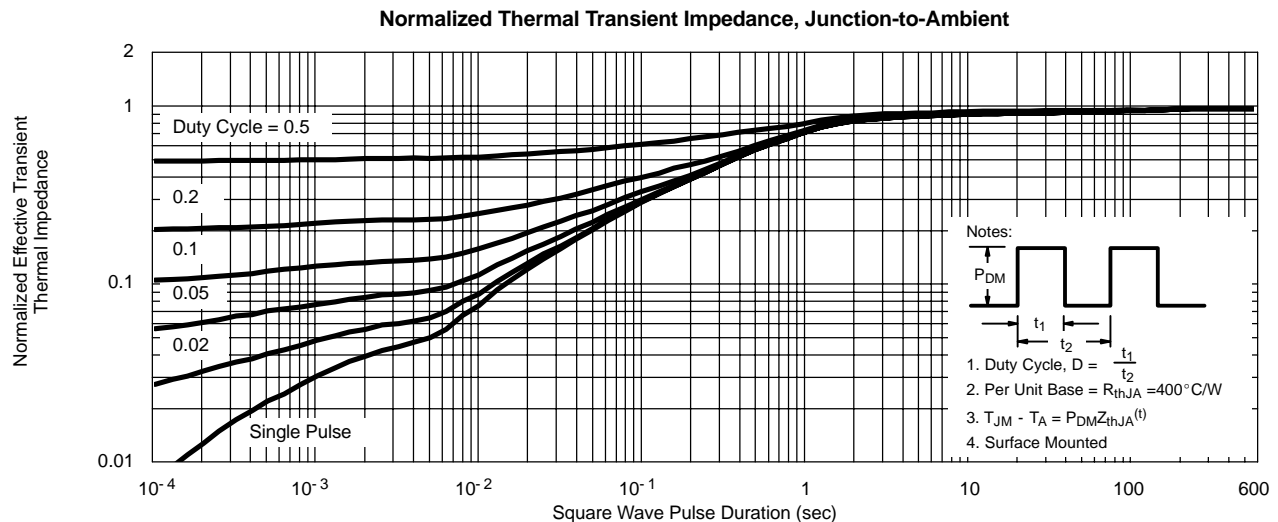
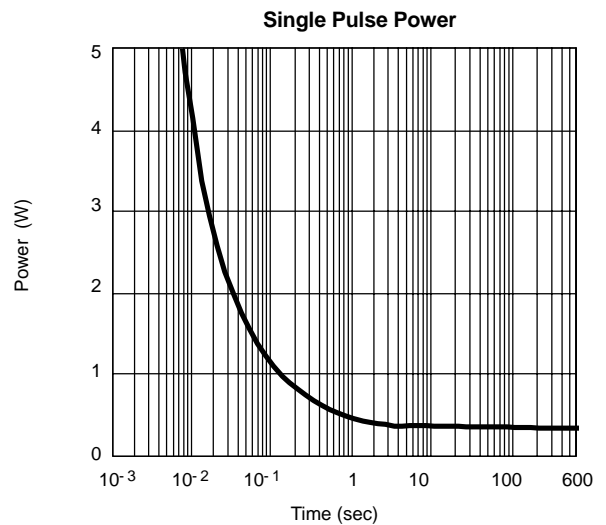
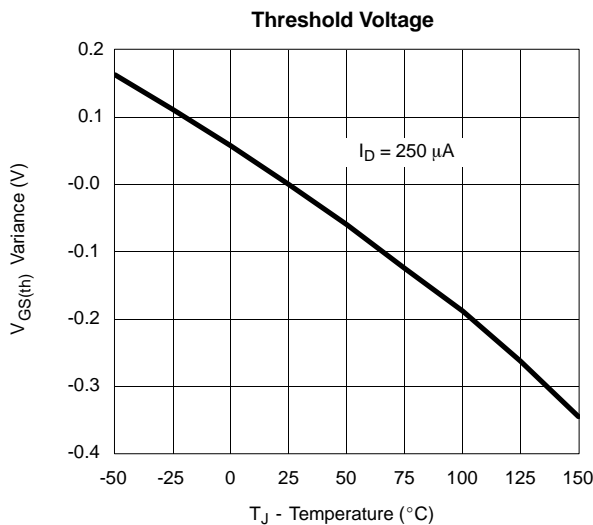
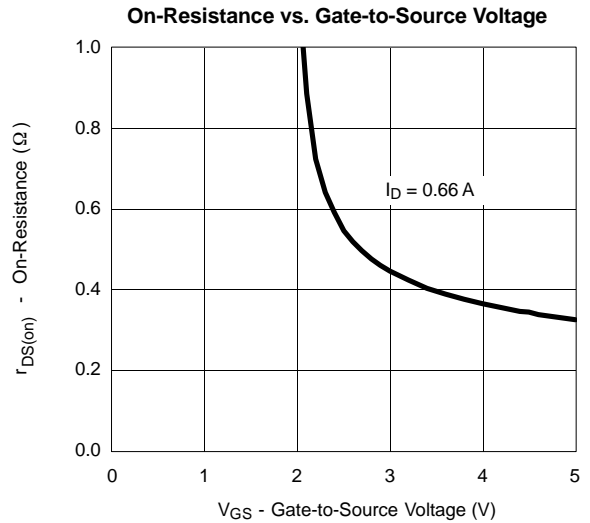
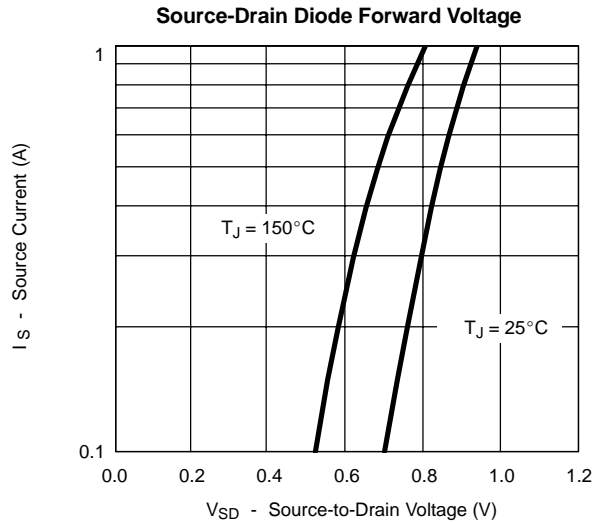



TYPICAL CHARACTERISTICS (25°C UNLESS NOTED)

N-CHANNEL

Normalized Thermal Transient Impedance, Junction-to-Foot

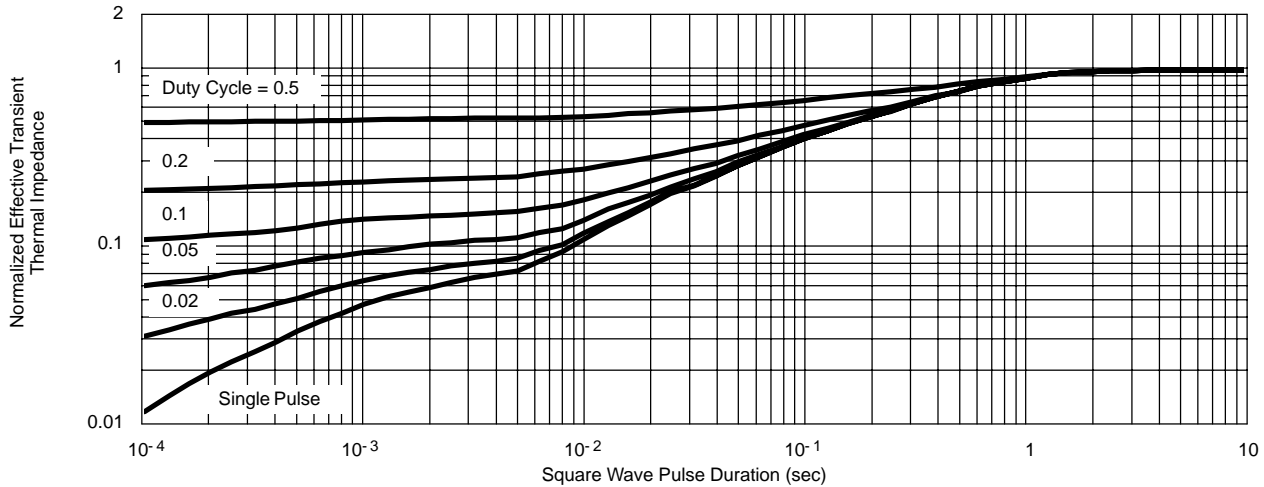

TYPICAL CHARACTERISTICS (25°C UNLESS NOTED)

P-CHANNEL

Output Characteristics

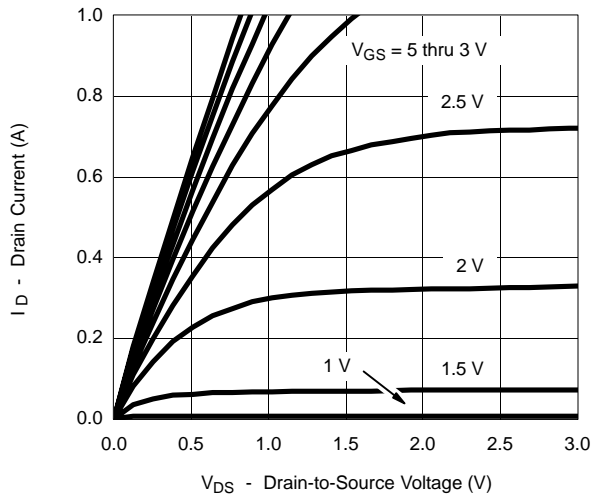

Transfer Characteristics

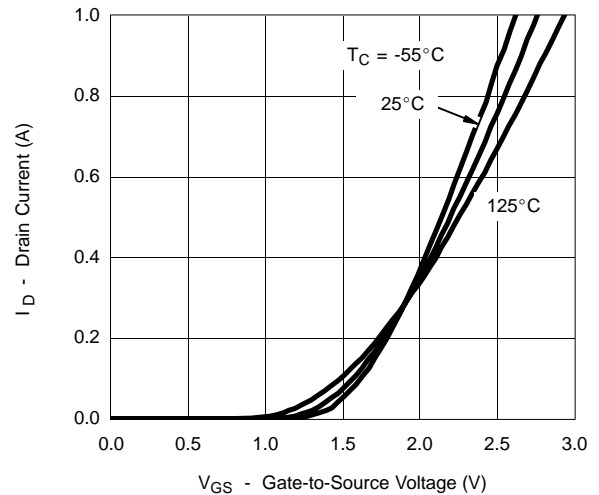

On-Resistance vs. Drain Current

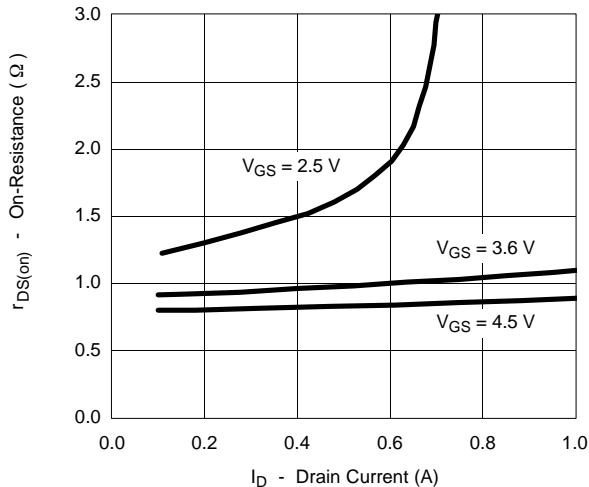

Capacitance

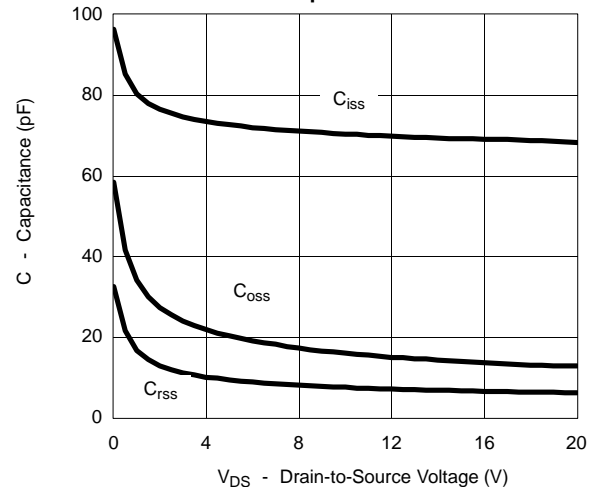

TYPICAL CHARACTERISTICS (25°C UNLESS NOTED)

P-CHANNEL

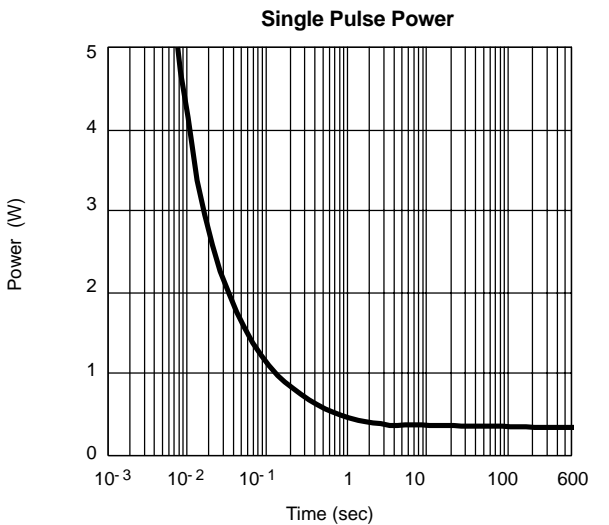
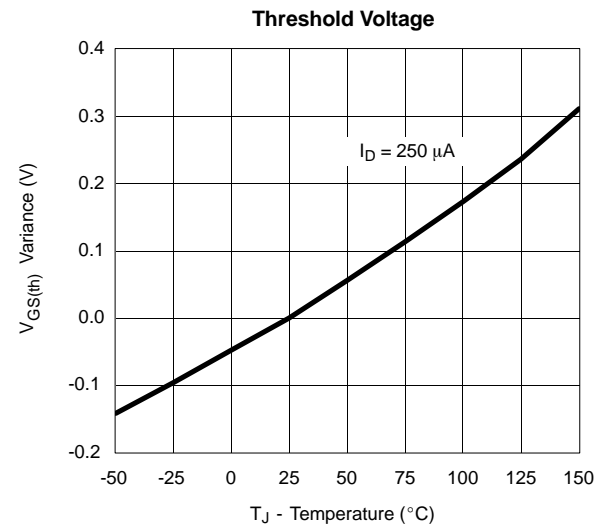
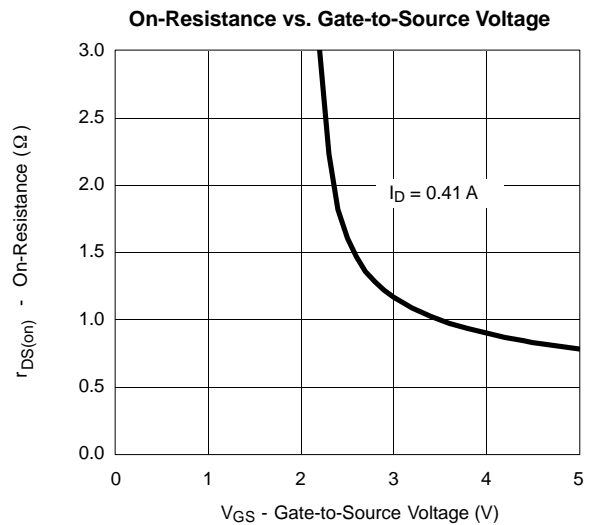
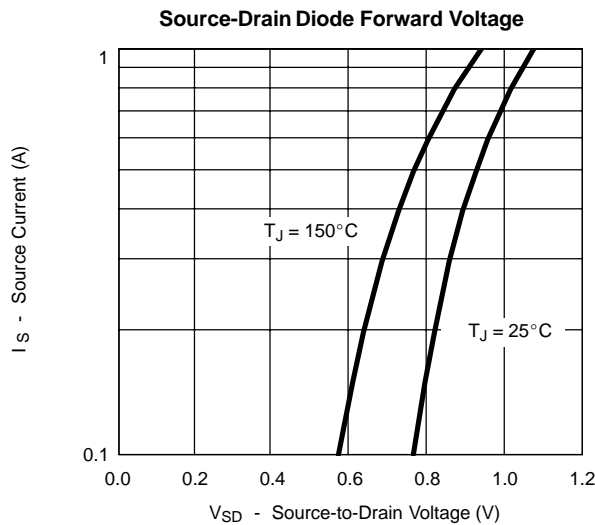
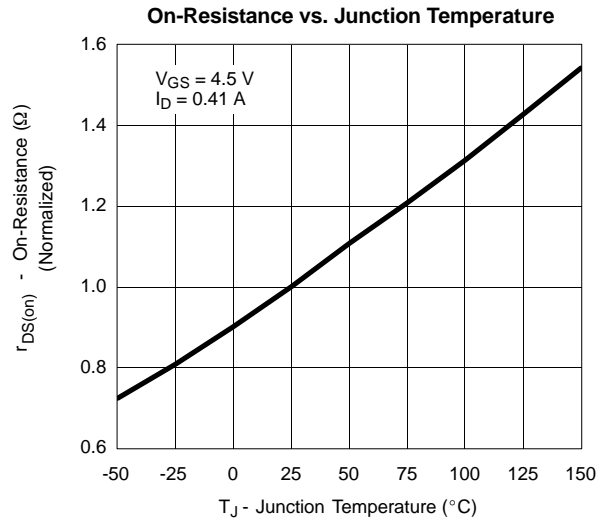
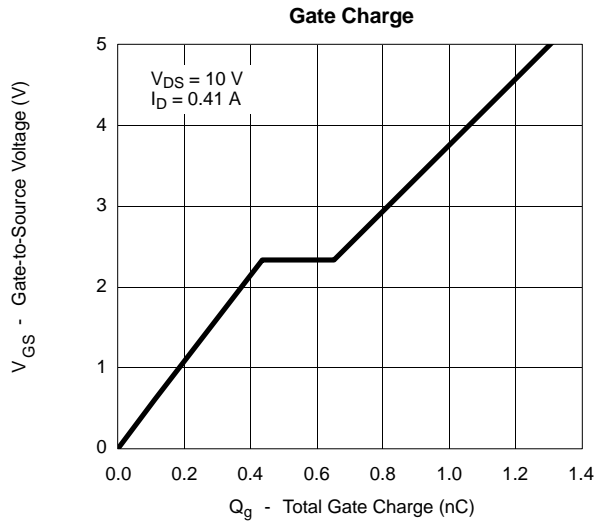



TYPICAL CHARACTERISTICS (25°C UNLESS NOTED)

P-CHANNEL

Normalized Thermal Transient Impedance, Junction-to-Ambient

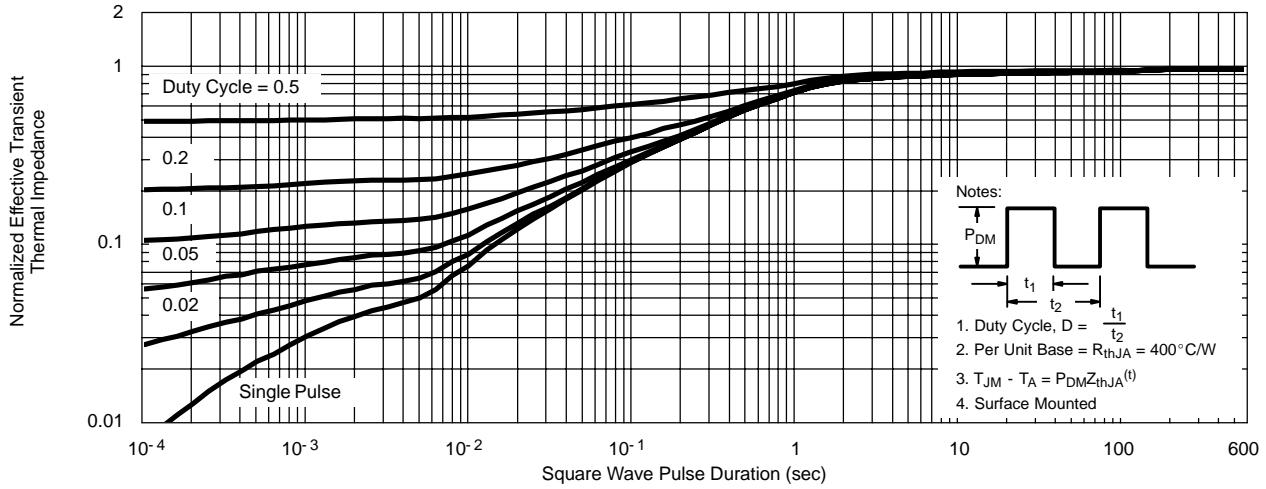

Normalized Thermal Transient Impedance, Junction-to-Foot

