



New Product

**Si7414DN**  
Vishay Siliconix

## N-Channel 60-V (D-S) MOSFET

PRODUCT SUMMARY		
$V_{DS}$ (V)	$r_{DS(on)}$ ( $\Omega$ )	$I_D$ (A)
60	0.025 @ $V_{GS} = 10$ V	8.7
	0.036 @ $V_{GS} = 4.5$ V	7.3

### FEATURES

- TrenchFET® Power MOSFET
- New Low Thermal Resistance
- PowerPAK™ 1212-8 Package with Low 1.07-mm-Profile
- PWM Optimized

### APPLICATIONS

- Primary Side Switch
- Synchronous Rectifier
- Motor Drives

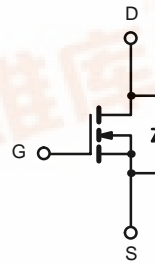
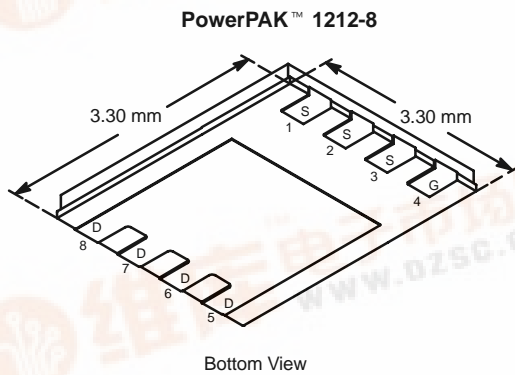

N-Channel MOSFET

ABSOLUTE MAXIMUM RATINGS ( $T_A = 25^\circ\text{C}$ UNLESS OTHERWISE NOTED)					
Parameter	Symbol	10 secs	Steady State	Unit	
Drain-Source Voltage	$V_{DS}$	60		V	
Gate-Source Voltage	$V_{GS}$	$\pm 20$			
Continuous Drain Current ( $T_J = 150^\circ\text{C}$ ) <sup>a</sup>	$I_D$	$T_A = 25^\circ\text{C}$	8.7	5.6	A
		$T_A = 70^\circ\text{C}$	7.0	4.4	
Pulsed Drain Current	$I_{DM}$	30			
Continuous Source Current (Diode Conduction) <sup>a</sup>	$I_S$	3.2	1.3		
Single Avalanche Current	$I_{AS}$	19		mJ	
Single Avalanche Energy		$E_{AS}$	18		
Maximum Power Dissipation <sup>a</sup>	$P_D$	$T_A = 25^\circ\text{C}$	3.8	1.5	W
		$T_A = 70^\circ\text{C}$	2.0	0.8	
Operating Junction and Storage Temperature Range	$T_J, T_{stg}$	-55 to 150		$^\circ\text{C}$	

THERMAL RESISTANCE RATINGS					
Parameter	Symbol	Typical	Maximum	Unit	
Maximum Junction-to-Ambient <sup>a</sup>	$R_{thJA}$	$t \leq 10$ sec	26	33	$^\circ\text{C/W}$
		Steady State	65	81	
Maximum Junction-to-Case (Drain)	$R_{thJC}$	1.9	2.4		

Notes:  
a. Surface Mounted on 1" x 1" FR4 Board.

**MOSFET SPECIFICATIONS (T<sub>J</sub> = 25 °C UNLESS OTHERWISE NOTED)**

Parameter	Symbol	Test Condition	Min	Typ	Max	Unit
<b>Static</b>						
Gate Threshold Voltage	V <sub>GS(th)</sub>	V <sub>DS</sub> = V <sub>GS</sub> , I <sub>D</sub> = 250 μA	1			V
Gate-Body Leakage	I <sub>GSS</sub>	V <sub>DS</sub> = 0 V, V <sub>GS</sub> = ±20 V			±100	nA
Zero Gate Voltage Drain Current	I <sub>DSS</sub>	V <sub>DS</sub> = 48 V, V <sub>GS</sub> = 0 V			1	μA
		V <sub>DS</sub> = 48 V, V <sub>GS</sub> = 0 V, T <sub>J</sub> = 55 °C			5	
On-State Drain Current <sup>a</sup>	I <sub>D(on)</sub>	V <sub>DS</sub> ≥ 5 V, V <sub>GS</sub> = 10 V	30			A
Drain-Source On-State Resistance <sup>a</sup>	r <sub>DS(on)</sub>	V <sub>GS</sub> = 10 V, I <sub>D</sub> = 8.7 A		0.021	0.025	Ω
		V <sub>GS</sub> = 4.5 V, I <sub>D</sub> = 7.3 A		0.030	0.036	
Forward Transconductance <sup>a</sup>	g <sub>fs</sub>	V <sub>DS</sub> = 15 V, I <sub>D</sub> = 8.7 A		18		S
Diode Forward Voltage <sup>a</sup>	V <sub>SD</sub>	I <sub>S</sub> = 3.2 A, V <sub>GS</sub> = 0 V		0.75	1.2	V
<b>Dynamic<sup>b</sup></b>						
Total Gate Charge	Q <sub>g</sub>	V <sub>DS</sub> = 30 V, V <sub>GS</sub> = 10 V, I <sub>D</sub> = 8.7 A		16	25	nC
Gate-Source Charge	Q <sub>gs</sub>			2.7		
Gate-Drain Charge	Q <sub>gd</sub>			4.4		
Gate Resistance	R <sub>G</sub>			1.0		Ω
Turn-On Delay Time	t <sub>d(on)</sub>	V <sub>DD</sub> = 30 V, R <sub>L</sub> = 30 Ω I <sub>D</sub> ≅ 1 A, V <sub>GEN</sub> = 10 V, R <sub>G</sub> = 6 Ω		15	25	ns
Rise Time	t <sub>r</sub>			12	20	
Turn-Off Delay Time	t <sub>d(off)</sub>			30	50	
Fall Time	t <sub>f</sub>			12	20	
Source-Drain Reverse Recovery Time	t <sub>rr</sub>		I <sub>F</sub> = 3.2 A, di/dt = 100 A/μs		45	

## Notes

- a. Pulse test; pulse width ≤ 300 μs, duty cycle ≤ 2%.  
 b. Guaranteed by design, not subject to production testing.

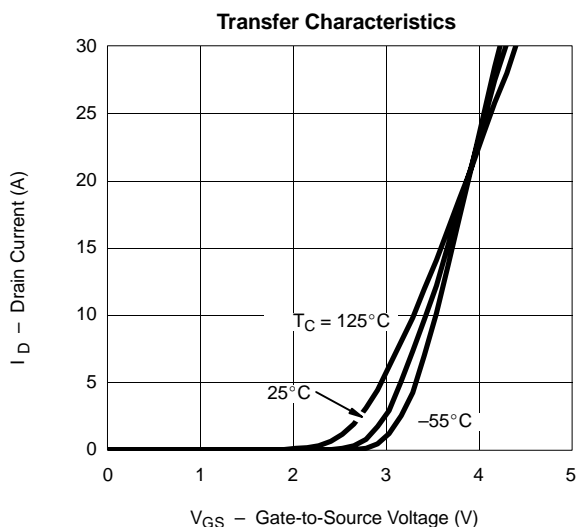
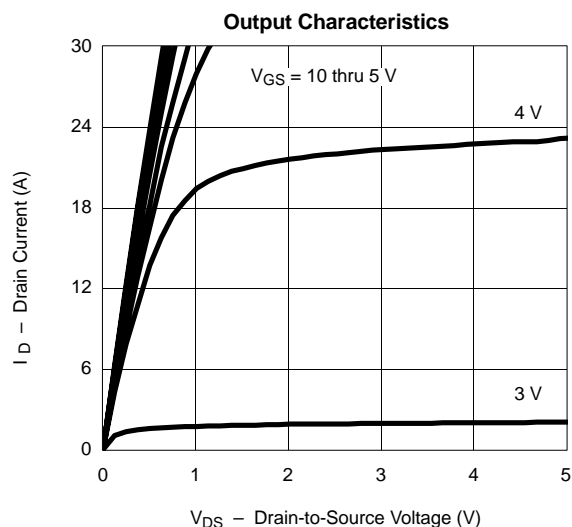
**TYPICAL CHARACTERISTICS (25 °C UNLESS NOTED)**



**TYPICAL CHARACTERISTICS (25°C UNLESS NOTED)**

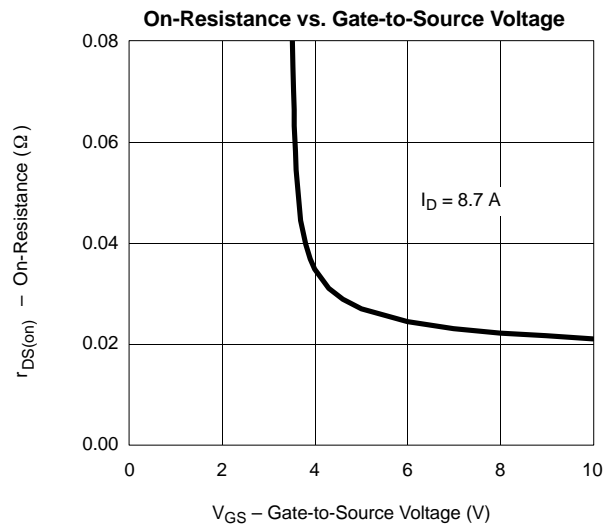
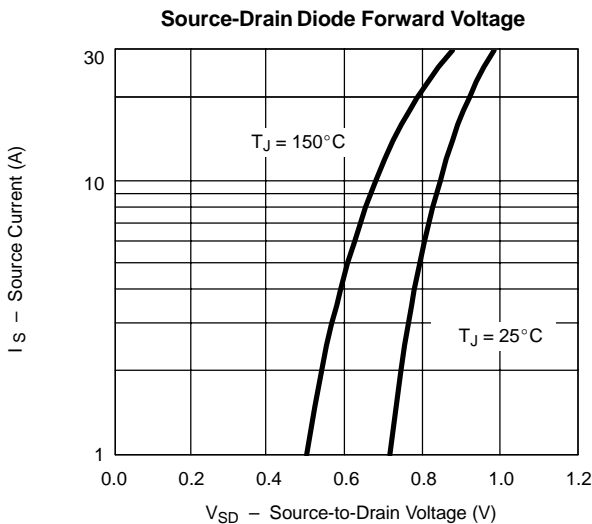
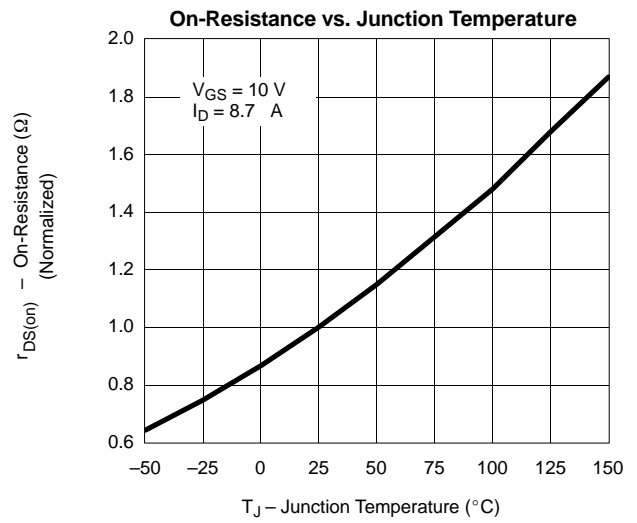
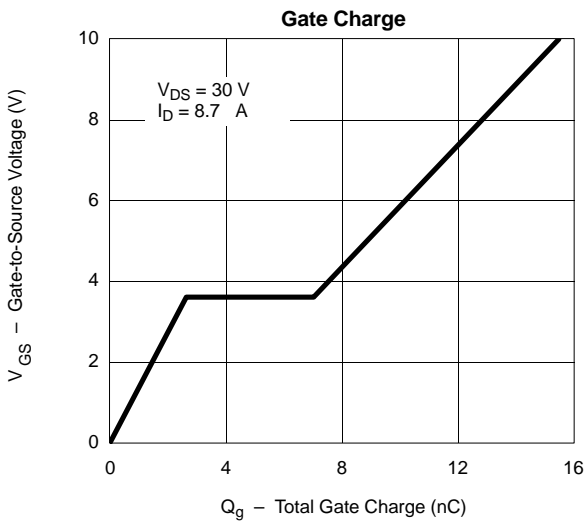
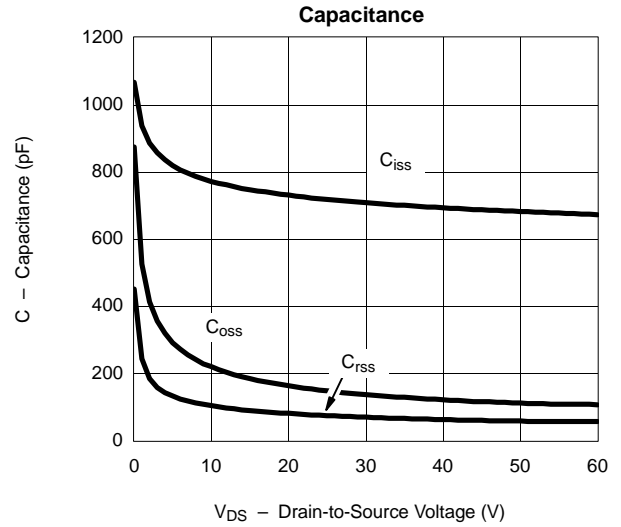
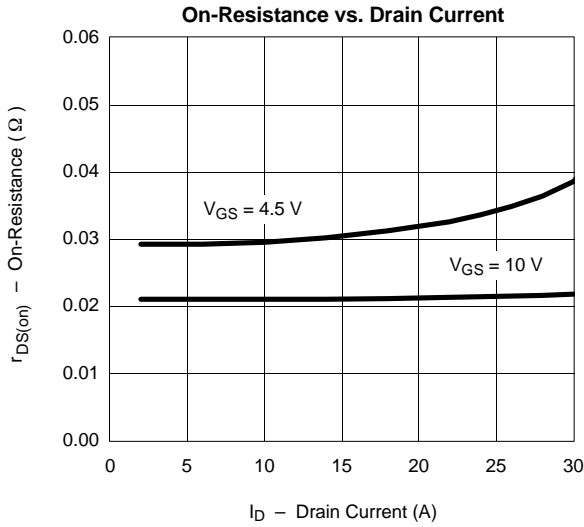



**TYPICAL CHARACTERISTICS (25°C UNLESS NOTED)**

