



New Product

Si7820DN
Vishay Siliconix

N-Channel 200-V (D-S) MOSFET

PRODUCT SUMMARY		
V_{DS} (V)	$r_{DS(on)}$ (Ω)	I_D (A)
200	0.240 @ $V_{GS} = 10$ V	2.6
	0.250 @ $V_{GS} = 6$ V	2.5

FEATURES

- PWM-Optimized TrenchFET® Power MOSFET
- 100% R_g Tested
- Avalanche Tested

APPLICATIONS

- Primary Side Switch
 - Telecom Power Supplies
 - Distributed Power Architectures
 - Miniature Power Modules

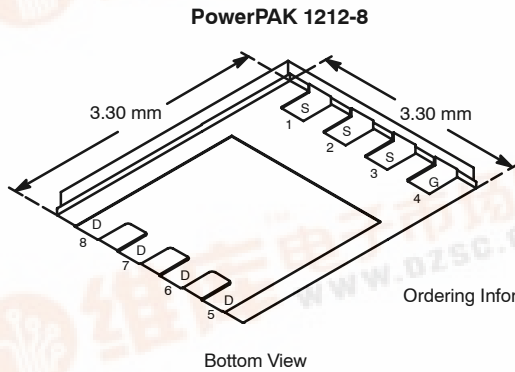

Ordering Information: Si7820DN-T1—E3

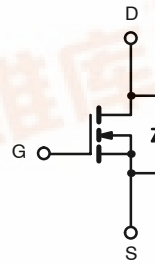

N-Channel MOSFET

ABSOLUTE MAXIMUM RATINGS ($T_A = 25^\circ\text{C}$ UNLESS OTHERWISE NOTED)					
Parameter	Symbol	10 secs	Steady State	Unit	
Drain-Source Voltage	V_{DS}	200		V	
Gate-Source Voltage	V_{GS}	± 20			
Continuous Drain Current ($T_J = 150^\circ\text{C}$) ^a	I_D	$T_A = 25^\circ\text{C}$	2.6	1.7	A
		$T_A = 70^\circ\text{C}$	2.1	1.3	
Pulsed Drain Current	I_{DM}	10			
Continuous Source Current (Diode Conduction) ^a	I_S	3.2	1.3		
Single Avalanche Current	I_{AS}	3.5			
Single Avalanche Energy	E_{AS}	L = 0.1 mH	0.6		mJ
Maximum Power Dissipation ^a			$T_A = 25^\circ\text{C}$	3.8	
	$T_A = 70^\circ\text{C}$	2.0	0.8		
Operating Junction and Storage Temperature Range	T_J, T_{stg}	-55 to 150		$^\circ\text{C}$	

THERMAL RESISTANCE RATINGS					
Parameter	Symbol	Typical	Maximum	Unit	
Maximum Junction-to-Ambient ^a	R_{thJA}	$t \leq 10$ sec	26	33	$^\circ\text{C/W}$
		Steady State	65	81	
Maximum Junction-to-Case (Drain)	R_{thJC}	1.9	2.4		

Notes:
a. Surface Mounted on 1" x 1" FR4 Board.

Si7820DN

Vishay Siliconix

New Product



MOSFET SPECIFICATIONS (T _J = 25 °C UNLESS OTHERWISE NOTED)						
Parameter	Symbol	Test Condition	Min	Typ	Max	Unit
Static						
Gate Threshold Voltage	V _{GS(th)}	V _{DS} = V _{GS} , I _D = 250 μA	2		4	V
Gate-Body Leakage	I _{GSS}	V _{DS} = 0 V, V _{GS} = ±20 V			±100	nA
Zero Gate Voltage Drain Current	I _{DSS}	V _{DS} = 200 V, V _{GS} = 0 V			1	μA
		V _{DS} = 200 V, V _{GS} = 0 V, T _J = 55 °C			5	
On-State Drain Current ^a	I _{D(on)}	V _{DS} ≥ 5 V, V _{GS} = 10 V	10			A
Drain-Source On-State Resistance ^a	r _{DS(on)}	V _{GS} = 10 V, I _D = 2.6 A		0.200	0.240	Ω
		V _{GS} = 6 V, I _D = 2.5 A		0.210	0.250	
Forward Transconductance ^a	g _{fs}	V _{DS} = 15 V, I _D = 2.6 A		8		S
Diode Forward Voltage ^a	V _{SD}	I _S = 3.2 A, V _{GS} = 0 V		0.78	1.2	V
Dynamic^b						
Total Gate Charge	Q _g	V _{DS} = 100 V, V _{GS} = 10 V, I _D = 2.6 A		12.1	18	nC
Gate-Source Charge	Q _{gs}			2.5		
Gate-Drain Charge	Q _{gd}			4.1		
Gate Resistance	R _g	f = 1 MHz	1	2.3	3.9	Ω
Turn-On Delay Time	t _{d(on)}	V _{DD} = 100 V, R _L = 100 Ω I _D ≅ 1 A, V _{GEN} = 10 V, R _G = 6 Ω		11	20	ns
Rise Time	t _r			12	20	
Turn-Off Delay Time	t _{d(off)}			30	45	
Fall Time	t _f			17	30	
Source-Drain Reverse Recovery Time	t _{rr}		I _F = 3.2 A, di/dt = 100 A/μs		65	

Notes

- a. Pulse test; pulse width ≤ 300 μs, duty cycle ≤ 2%.
- b. Guaranteed by design, not subject to production testing.

TYPICAL CHARACTERISTICS (25 °C UNLESS NOTED)

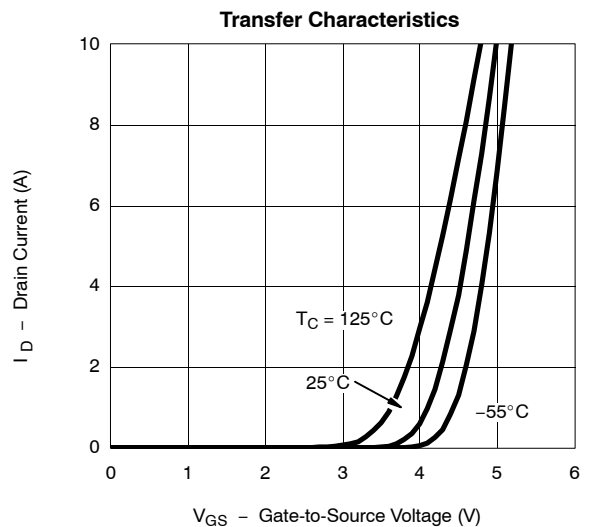
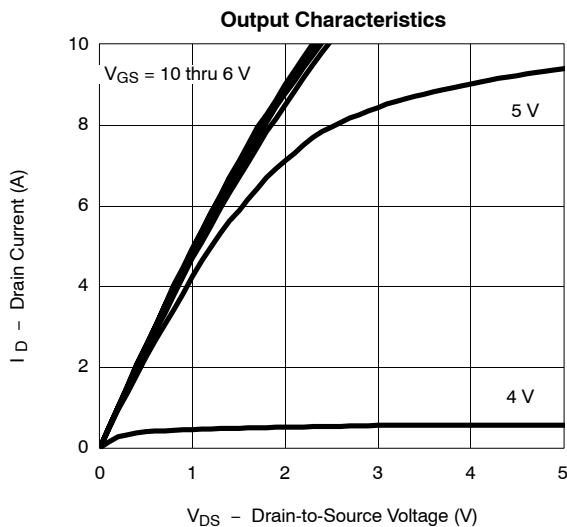



TYPICAL CHARACTERISTICS (25°C UNLESS NOTED)

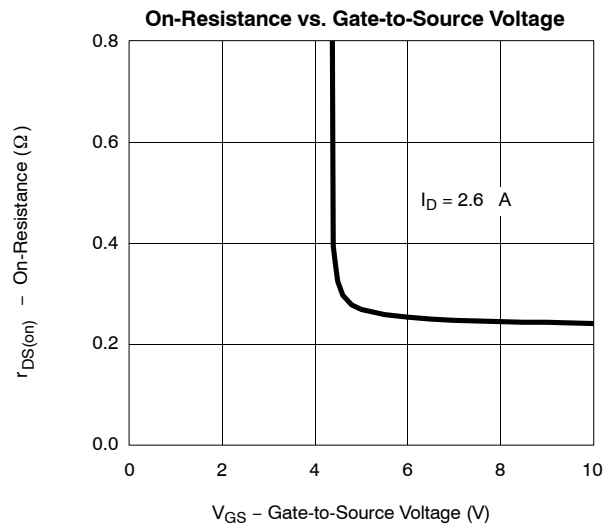
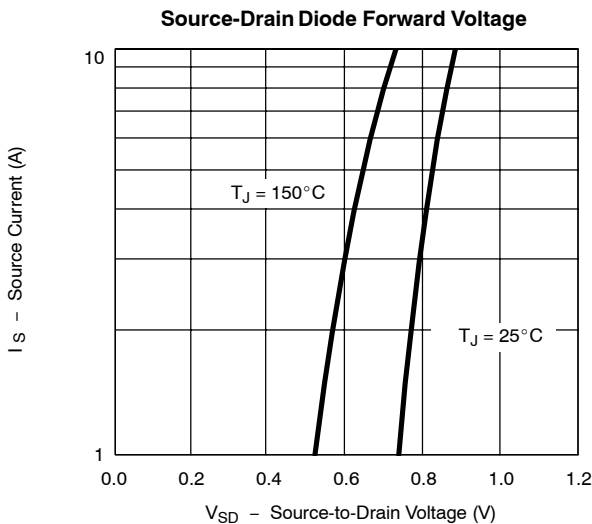
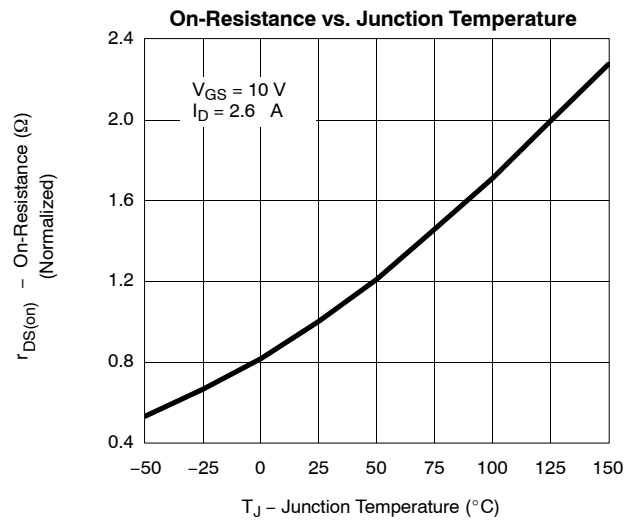
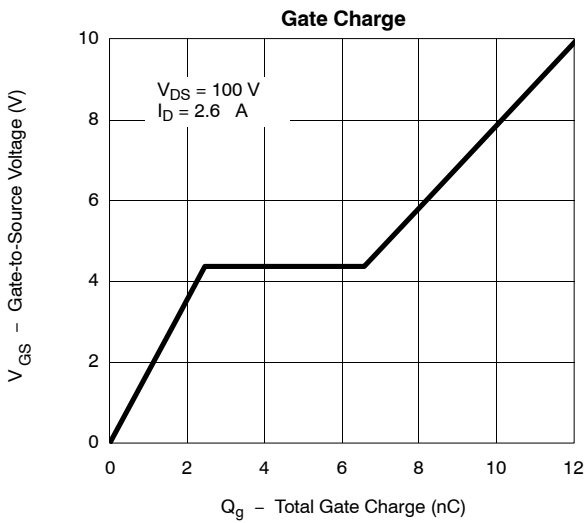
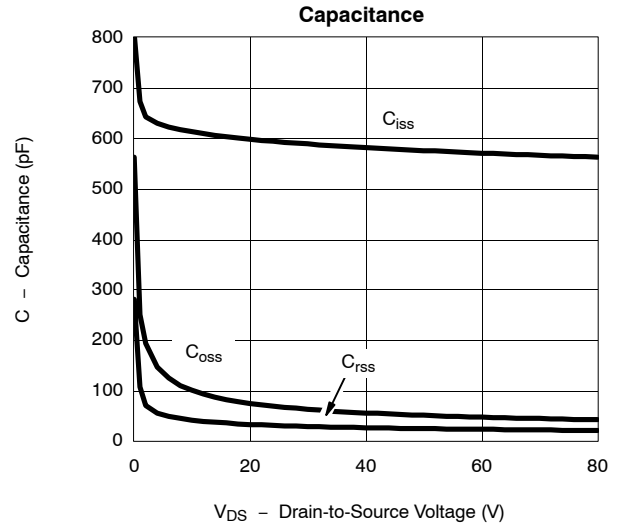
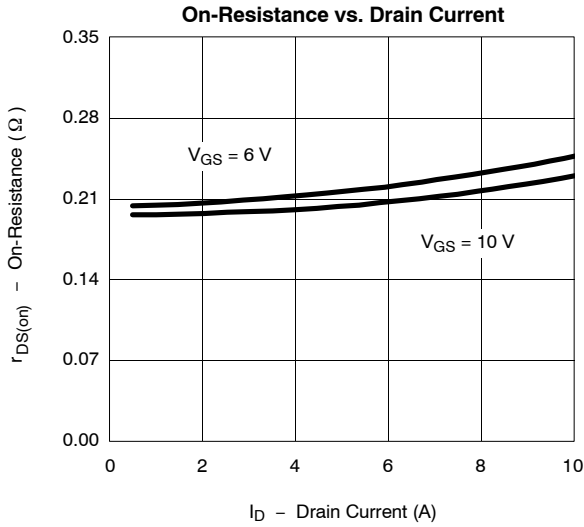



TYPICAL CHARACTERISTICS (25°C UNLESS NOTED)

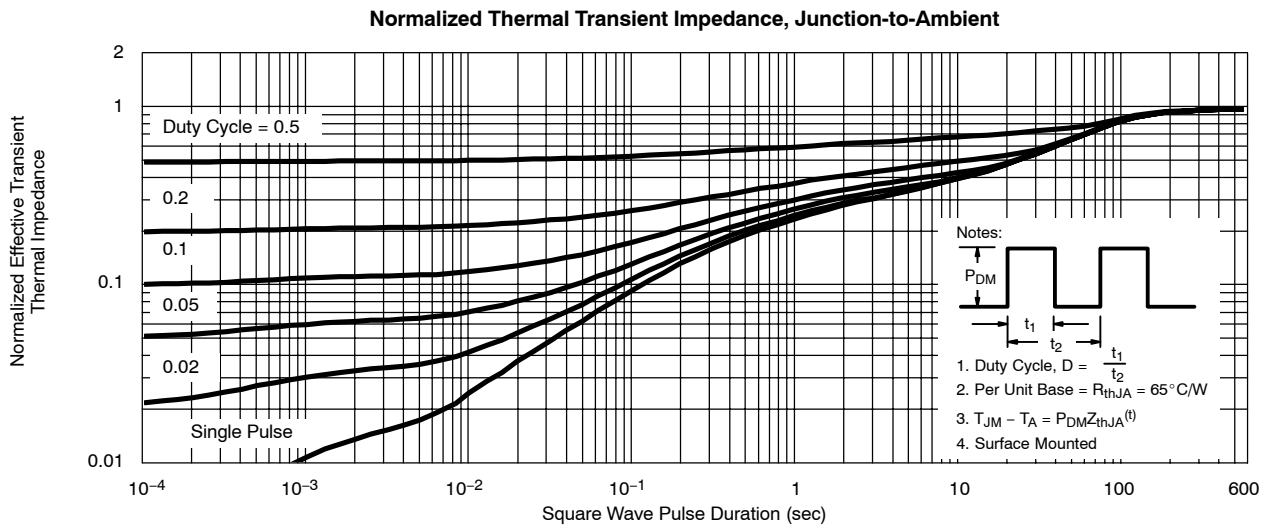
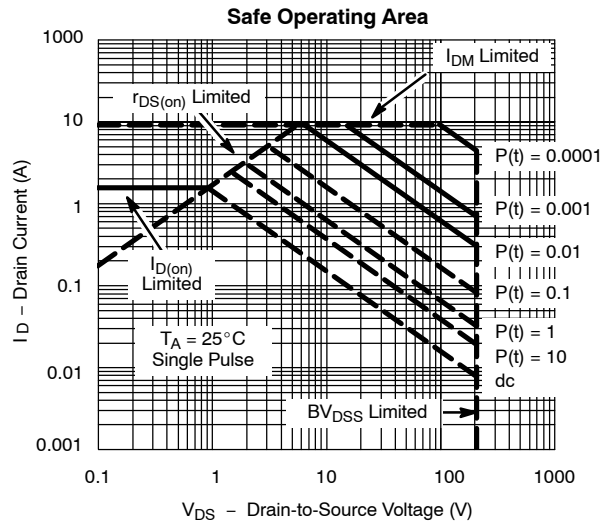
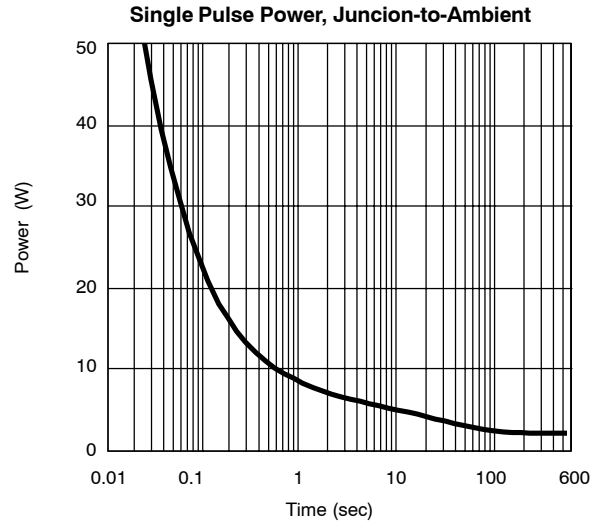
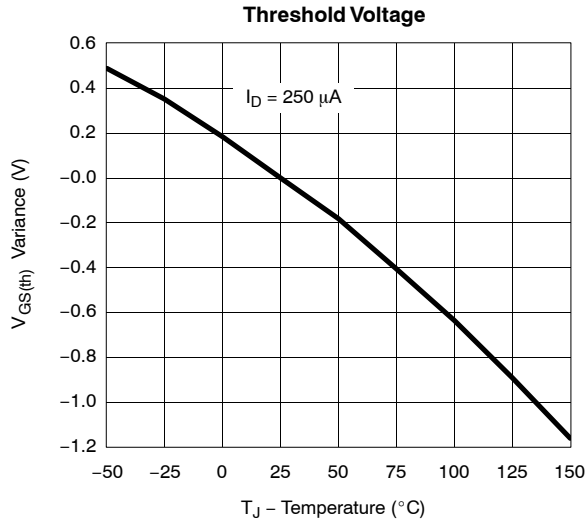



New Product

Si7820DN
Vishay Siliconix

TYPICAL CHARACTERISTICS (25°C UNLESS NOTED)

