



## Dual N-Channel 30-V (D-S) MOSFET with Schottky Diode

PRODUCT SUMMARY			
	V <sub>DS</sub> (V)	r <sub>DS(on)</sub> (Ω)	I <sub>D</sub> (A)
Channel-1	30	0.022 @ V <sub>GS</sub> = 10 V	10
		0.030 @ V <sub>GS</sub> = 4.5 V	8
Channel-2		0.022 @ V <sub>GS</sub> = 10 V	10
		0.028 @ V <sub>GS</sub> = 4.5 V	8

SCHOTTKY PRODUCT SUMMARY		
V <sub>DS</sub> (V)	V <sub>SD</sub> (V) Diode Forward Voltage	I <sub>F</sub> (A)
30	0.50 V @ 1.0 A	3.0

### FEATURES

- LITTLE FOOT *Plus*™ Schottky
- PWM Optimized
- New Low Thermal Resistance PowerPAK package with low 1.07 mm profile

### APPLICATIONS

- Asymmetrical Buck-Boost DC/DC Converter

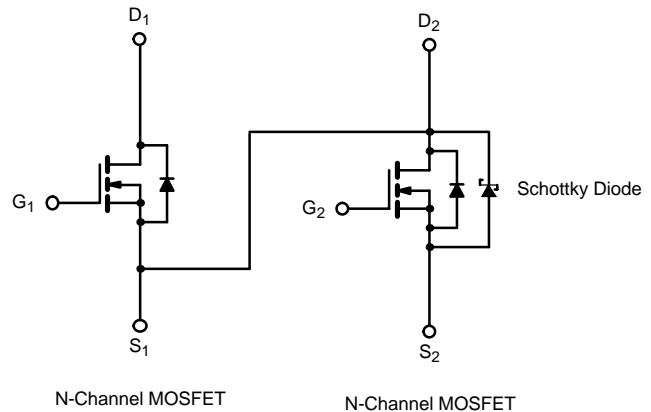
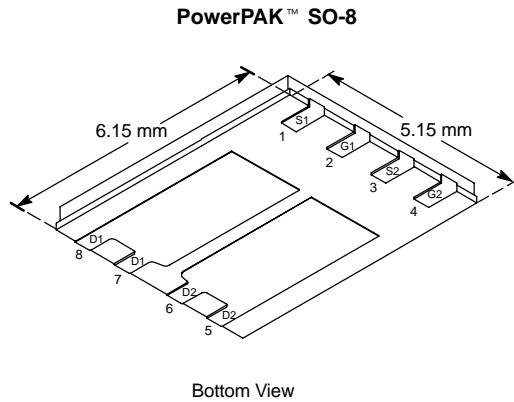

ABSOLUTE MAXIMUM RATINGS (T <sub>A</sub> = 25 °C UNLESS OTHERWISE NOTED)						
Parameter	Symbol	10 secs		Steady State		Unit
		Channel-1	Channel-2	Channel-1	Channel-2	
Drain-Source Voltage	V <sub>DS</sub>	30				V
Gate-Source Voltage	V <sub>GS</sub>	± 20	± 12	± 20	± 12	
Continuous Drain Current (T <sub>J</sub> = 150 °C) <sup>a</sup>	I <sub>D</sub>	T <sub>A</sub> = 25 °C		6.4		A
		T <sub>A</sub> = 70 °C		5.1		
Pulsed Drain Current	I <sub>DM</sub>	30				
Continuous Source Current (Diode Conduction) <sup>a</sup>	I <sub>S</sub>	2.9		1.1		
Maximum Power Dissipation <sup>a</sup>	P <sub>D</sub>	T <sub>A</sub> = 25 °C		1.4		W
		T <sub>A</sub> = 70 °C		0.9		
Operating Junction and Storage Temperature Range	T <sub>J</sub> , T <sub>stg</sub>	-55 to 150				°C

THERMAL RESISTANCE RATINGS							
Parameter	Symbol	MOSFET		Schottky		Unit	
		Typical	Maximum	Typical	Maximum		
Maximum Junction-to-Ambient <sup>a</sup>	R <sub>thJA</sub>	t ≤ 10 sec	26	35	26	35	°C/W
		Steady-State	60	85	60	85	
Maximum Junction-to-Case (Drain)	R <sub>thJC</sub>	4.1	6.0	4.1	6.0		

Notes

a. Surface Mounted on 1" x 1" FR4 Board.

**MOSFET SPECIFICATIONS (T<sub>J</sub> = 25 °C UNLESS OTHERWISE NOTED).**

Parameter	Symbol	Test Condition	Min	Typ <sup>a</sup>	Max	Unit		
<b>Static</b>								
Gate Threshold Voltage	V <sub>GS(th)</sub>	V <sub>DS</sub> = V <sub>GS</sub> , I <sub>D</sub> = 250 μA	Ch-1	1.0		3.0	V	
			Ch-2	0.8		2.0		
Gate-Body Leakage	I <sub>GSS</sub>	V <sub>DS</sub> = 0 V, V <sub>GS</sub> = ±20 V	Ch-1			±100	nA	
		V <sub>DS</sub> = 0 V, V <sub>GS</sub> = ±12 V	Ch-2			±100		
Zero Gate Voltage Drain Current	I <sub>DSS</sub>	V <sub>DS</sub> = 24 V, V <sub>GS</sub> = 0 V	Ch-1			1	μA	
			Ch-2			100		
		V <sub>DS</sub> = 24 V, V <sub>GS</sub> = 0 V, T <sub>J</sub> = 85 °C	Ch-1			15		
			Ch-2			2000		
On-State Drain Current <sup>b</sup>	I <sub>D(on)</sub>	V <sub>DS</sub> = 5 V, V <sub>GS</sub> = 10 V	Ch-1	20			A	
			Ch-2	20				
Drain-Source On-State Resistance <sup>b</sup>	r <sub>DS(on)</sub>	V <sub>GS</sub> = 10 V, I <sub>D</sub> = 7.5 A	Ch-1		0.017	0.022	Ω	
			Ch-2		0.016	0.022		
		V <sub>GS</sub> = 4.5 V, I <sub>D</sub> = 6.5 A	Ch-1		0.024	0.030		
			Ch-2		0.020	0.028		
Forward Transconductance <sup>b</sup>	g <sub>fs</sub>	V <sub>DS</sub> = 15 V, I <sub>D</sub> = 7.5 A	Ch-1		19		S	
			Ch-2		21			
Diode Forward Voltage <sup>b</sup>	V <sub>SD</sub>	I <sub>S</sub> = 1 A, V <sub>GS</sub> = 0 V	Ch-1		0.75	1.2	V	
			Ch-2		0.47	0.5		
<b>Dynamic<sup>a</sup></b>								
Total Gate Charge	Q <sub>g</sub>	V <sub>DS</sub> = 15 V, V <sub>GS</sub> = 4.5 V, I <sub>D</sub> = 7.5 A	Ch-1		7	11	nC	
			Ch-2		11.5	18		
Gate-Source Charge	Q <sub>gs</sub>		Ch-1		2.9			
			Ch-2		3.8			
Gate-Drain Charge	Q <sub>gd</sub>		Ch-1		2.5			
			Ch-2		3.5			
Gate Resistance	R <sub>G</sub>		Ch-1		1.5		Ω	
			Ch-2		1.8			
Turn-On Delay Time	t <sub>d(on)</sub>		V <sub>DD</sub> = 15 V, R <sub>L</sub> = 15 Ω I <sub>D</sub> = 1 A, V <sub>GEN</sub> = 10 V, R <sub>G</sub> = 6 Ω	Ch-1		9	15	ns
				Ch-2		12	20	
Rise Time	t <sub>r</sub>	Ch-1			10	17		
		Ch-2			10	17		
Turn-Off Delay Time	t <sub>d(off)</sub>	Ch-1			19	30		
		Ch-2			40	66		
Fall Time	t <sub>f</sub>	Ch-1			9	15		
		Ch-2			9	15		
Source-Drain Reverse Recovery Time	t <sub>rr</sub>	I <sub>F</sub> = 1.7 A, di/dt = 100 A/μs		Ch-1		35	55	
				Ch-2		28	45	

## Notes

- a. Guaranteed by design, not subject to production testing.  
b. Pulse test; pulse width ≤ 300 μs, duty cycle ≤ 2%.

**SCHOTTKY SPECIFICATIONS (T<sub>J</sub> = 25 °C UNLESS OTHERWISE NOTED)**

Parameter	Symbol	Test Condition	Min	Typ	Max	Unit
Forward Voltage Drop	V <sub>F</sub>	I <sub>F</sub> = 1.0 A		0.47	0.50	V
		I <sub>F</sub> = 1.0 A, T <sub>J</sub> = 125 °C		0.36	0.42	
Maximum Reverse Leakage Current	I <sub>rm</sub>	V <sub>r</sub> = 30 V		0.004	0.100	mA
		V <sub>r</sub> = 30 V, T <sub>J</sub> = 100 °C		0.7	10	
		V <sub>r</sub> = -30 V, T <sub>J</sub> = 125 °C		3.0	20	
Junction Capacitance	C <sub>T</sub>	V <sub>r</sub> = 10 V		50		pF



**TYPICAL CHARACTERISTICS (25 °C UNLESS NOTED)**

**MOSFET CHANNEL-1**

**Output Characteristics**

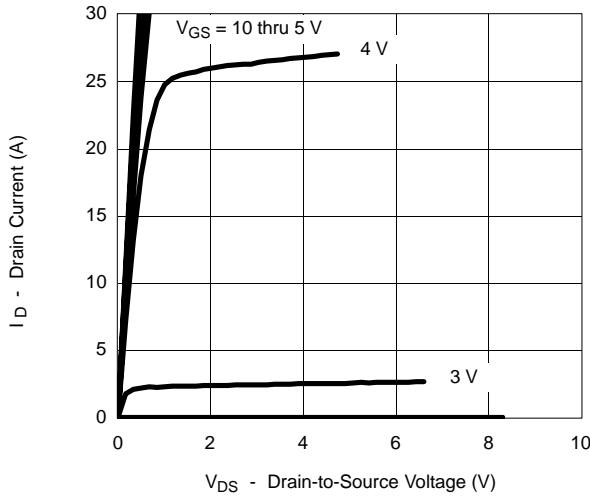

**Transfer Characteristics**

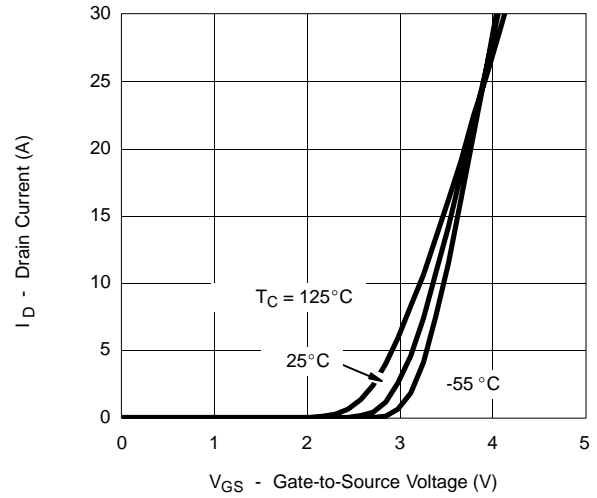

**On-Resistance vs. Drain Current**

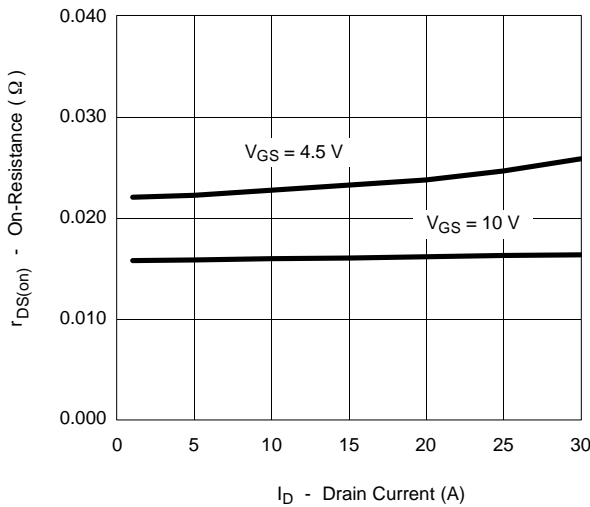

**Capacitance**

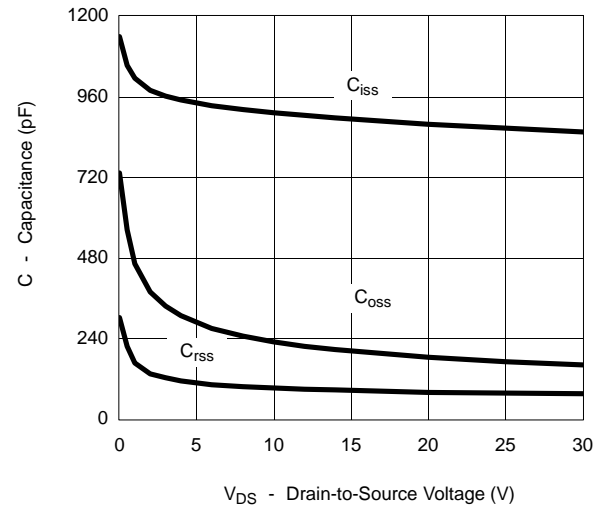

**Gate Charge**

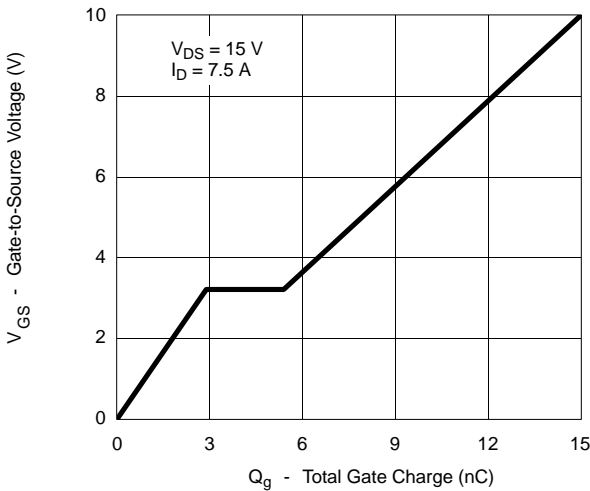

**On-Resistance vs. Junction Temperature**

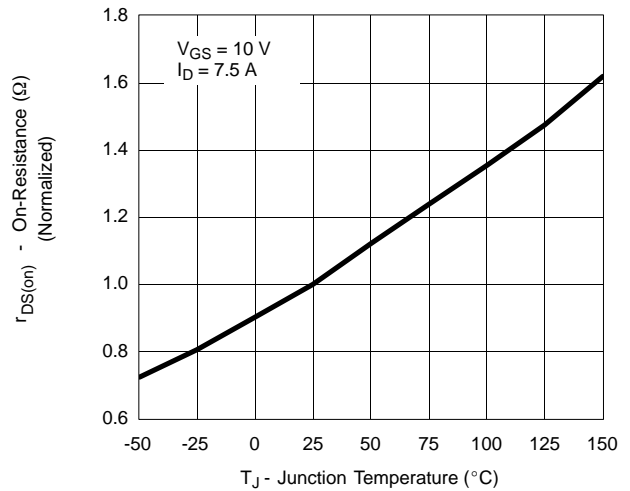

**TYPICAL CHARACTERISTICS (25 °C UNLESS NOTED)**

**MOSFET CHANNEL-1**

Source-Drain Diode Forward Voltage

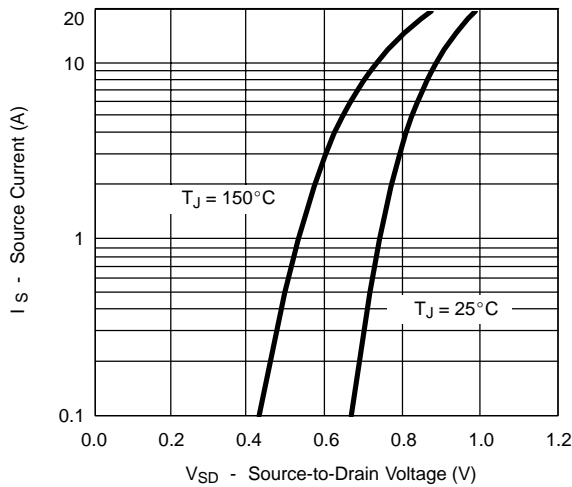

On-Resistance vs. Gate-to-Source Voltage

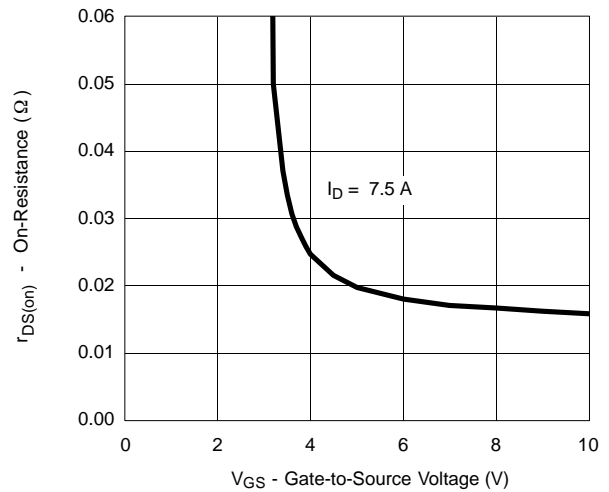

Threshold Voltage

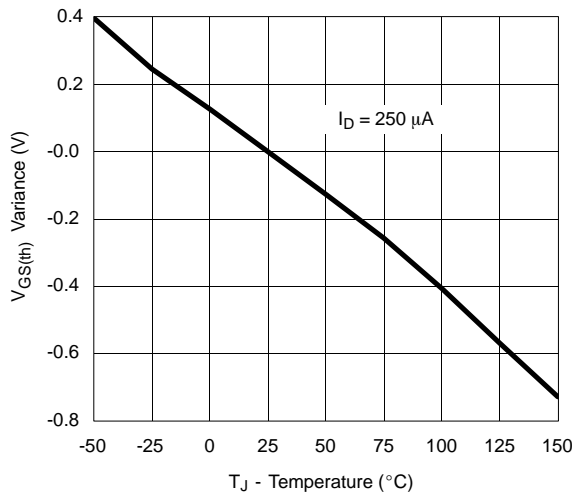

Single Pulse Power, Junction-to-Ambient

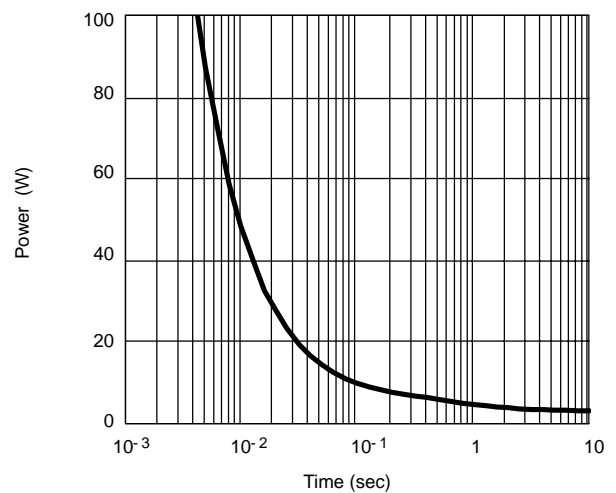

Safe Operating Area, Junction-to-Foot

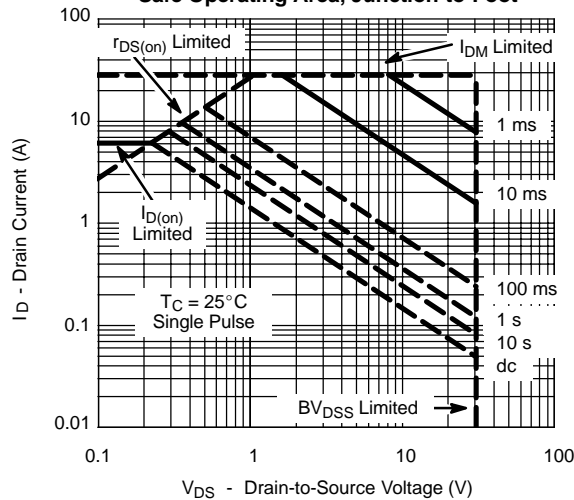



**TYPICAL CHARACTERISTICS (25°C UNLESS NOTED) MOSFET CHANNEL 1**

Normalized Thermal Transient Impedance, Junction-to-Ambient

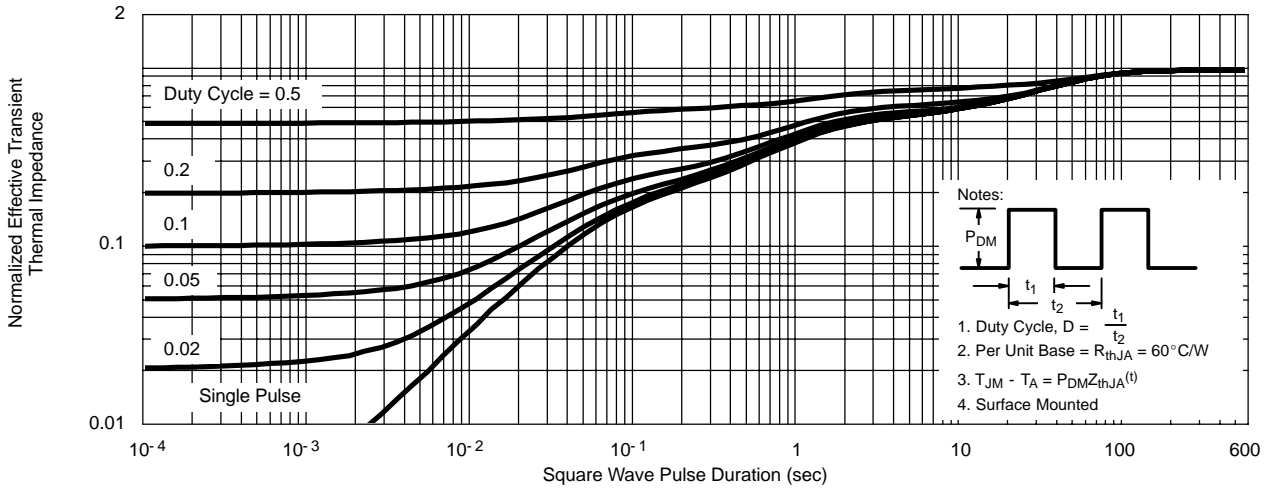

Normalized Thermal Transient Impedance, Junction-to-Case

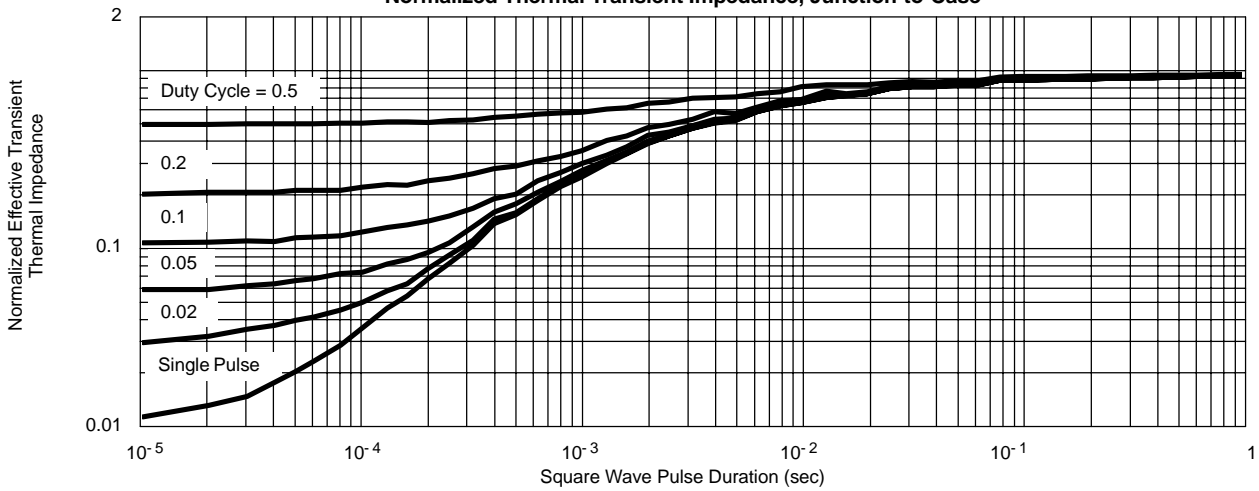

**TYPICAL CHARACTERISTICS (25 °C UNLESS NOTED)**

**MOSFET CHANNEL-2**

**Output Characteristics**

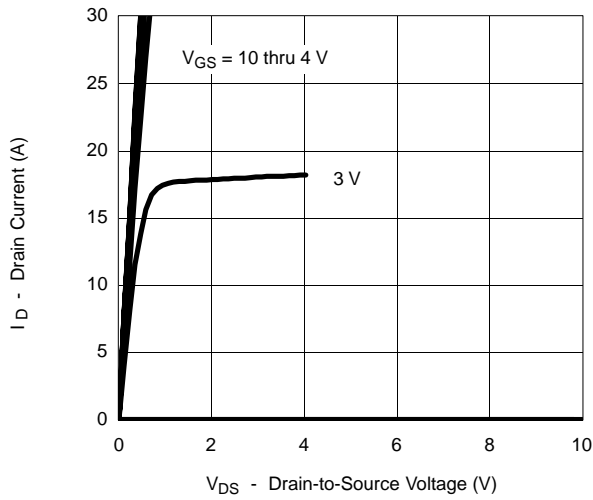

**Transfer Characteristics**

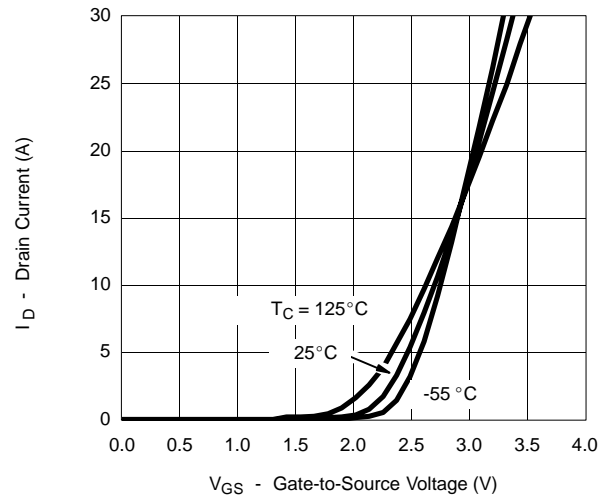

**On-Resistance vs. Drain Current**

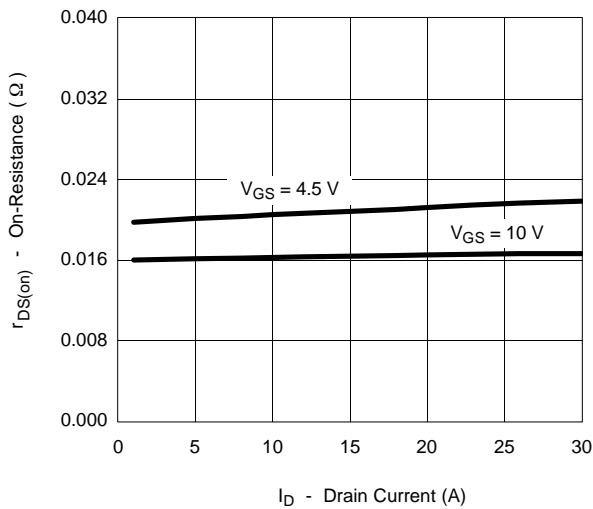

**Capacitance**

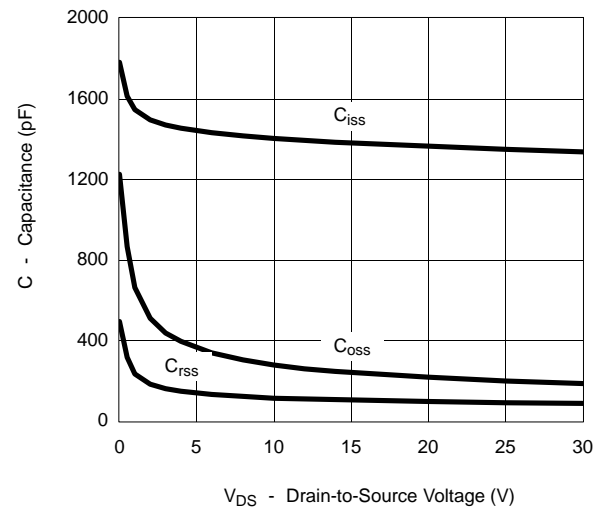

**Gate Charge**

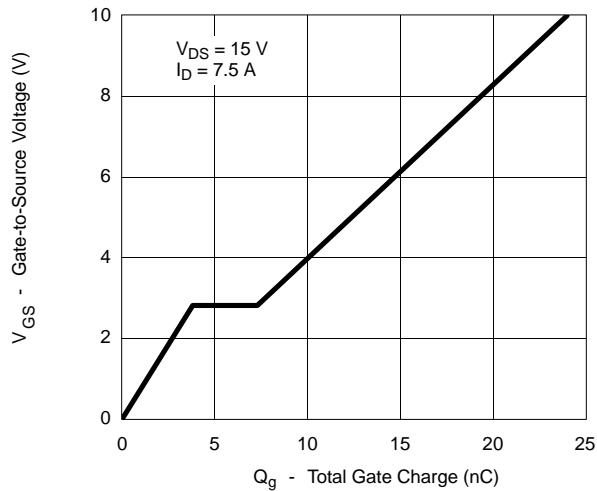

**On-Resistance vs. Junction Temperature**

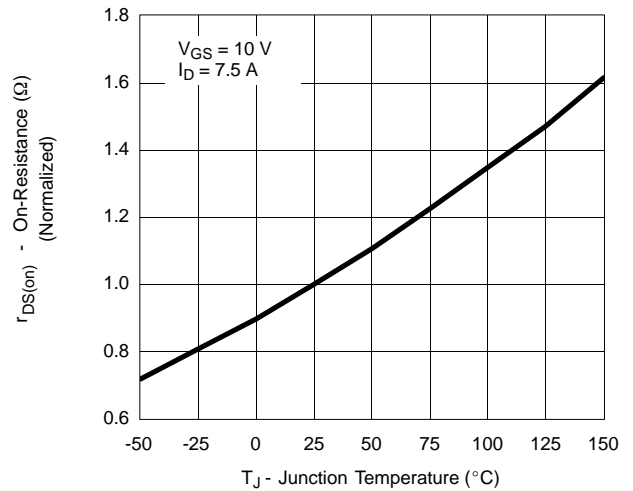



**TYPICAL CHARACTERISTICS (25°C UNLESS NOTED) MOSFET CHANNEL-2**

Source-Drain Diode Forward Voltage

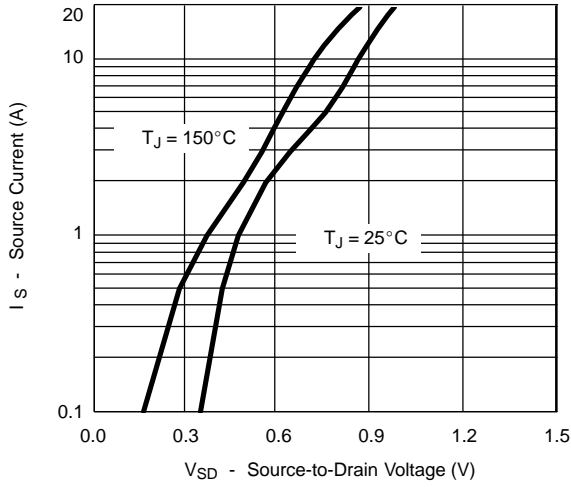

On-Resistance vs. Gate-to-Source Voltage

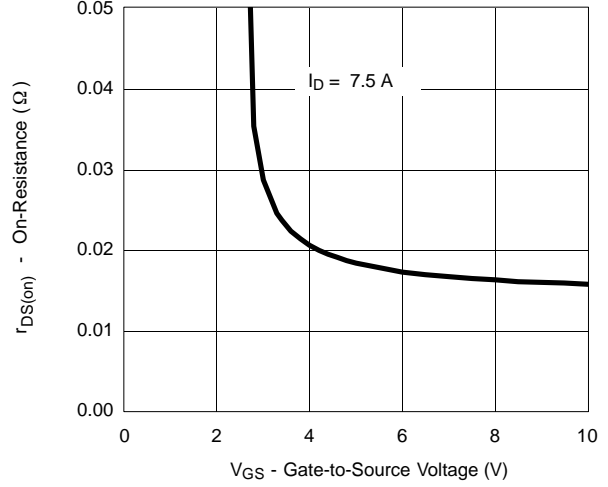

Threshold Voltage

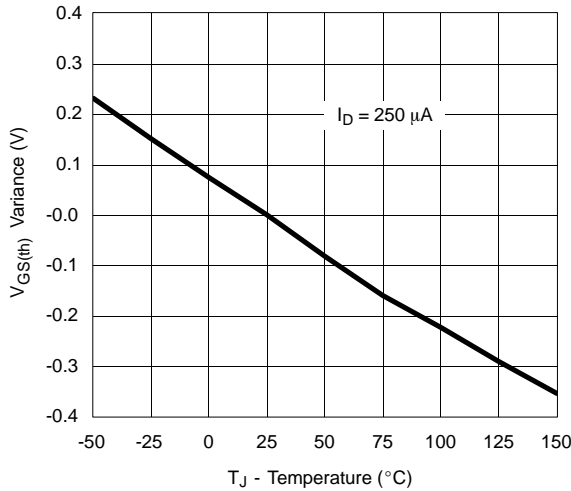

Single Pulse Power, Junction-to-Ambient

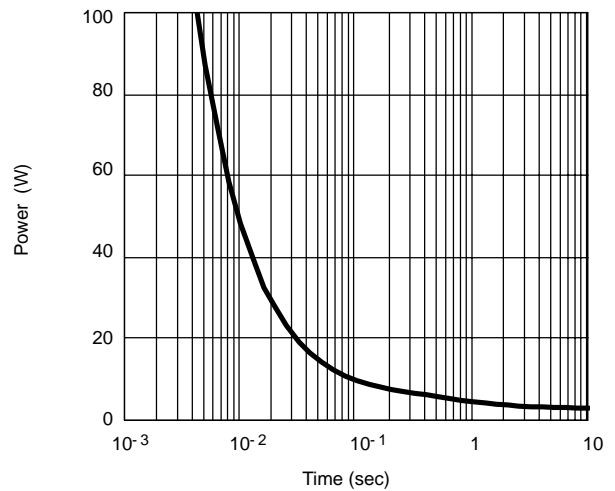

Safe Operating Area, Junction-to-Foot

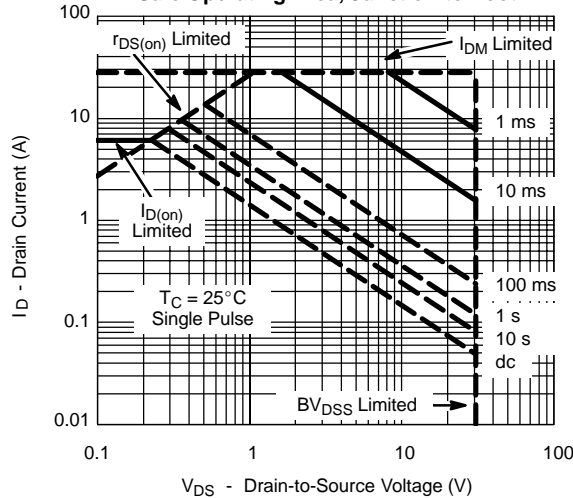

**TYPICAL CHARACTERISTICS (25 °C UNLESS NOTED)**

**MOSFET CHANNEL-2**

Normalized Thermal Transient Impedance, Junction-to-Ambient

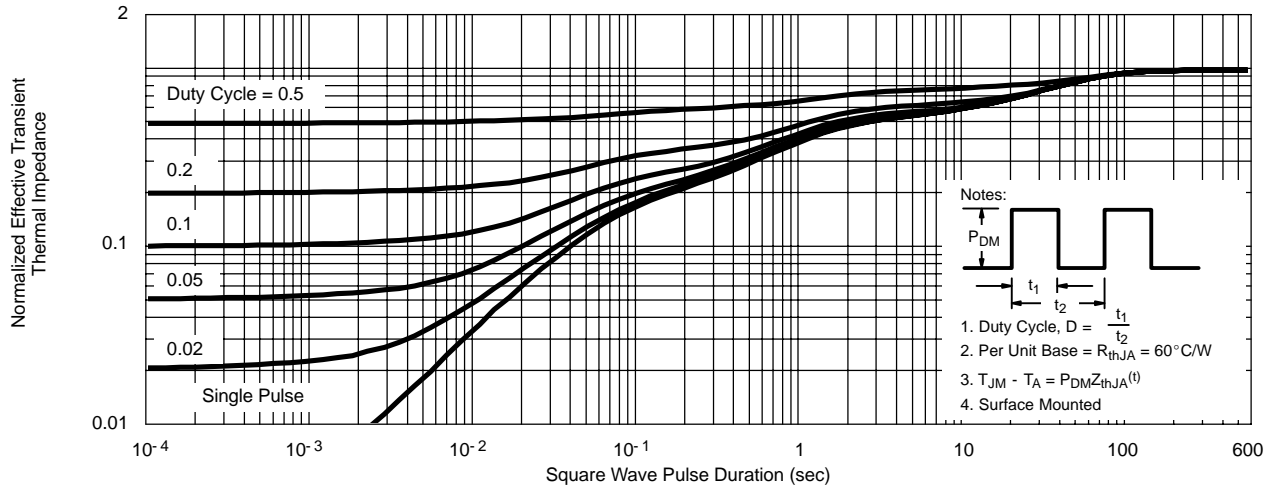

Normalized Thermal Transient Impedance, Junction-to-Case

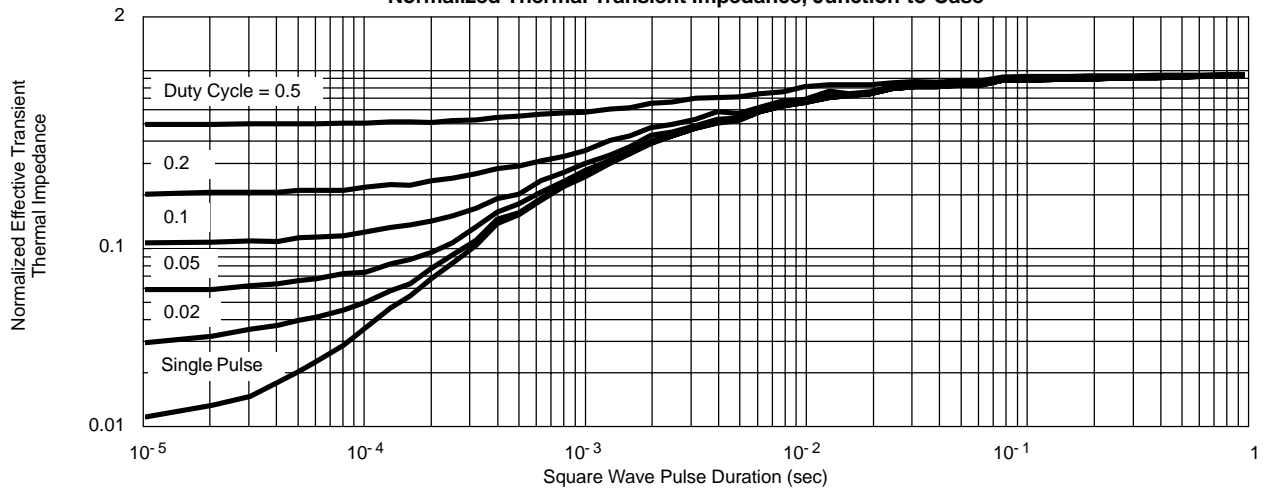





**TYPICAL CHARACTERISTICS (25°C UNLESS NOTED)** **SCHOTTKY**

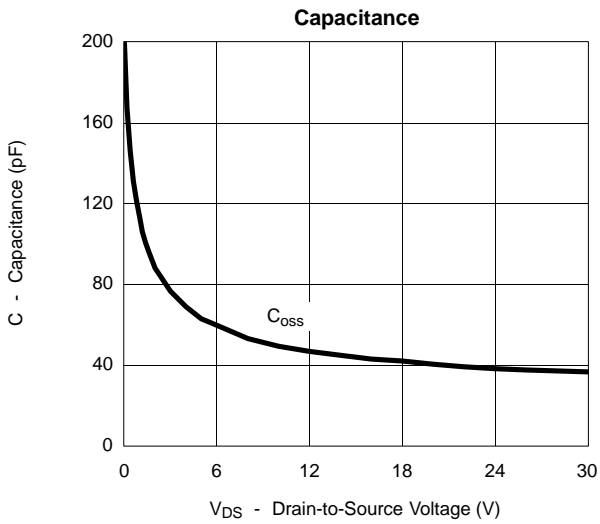
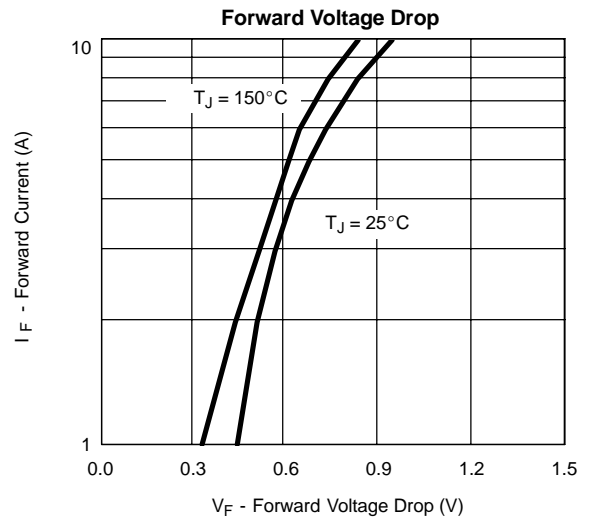
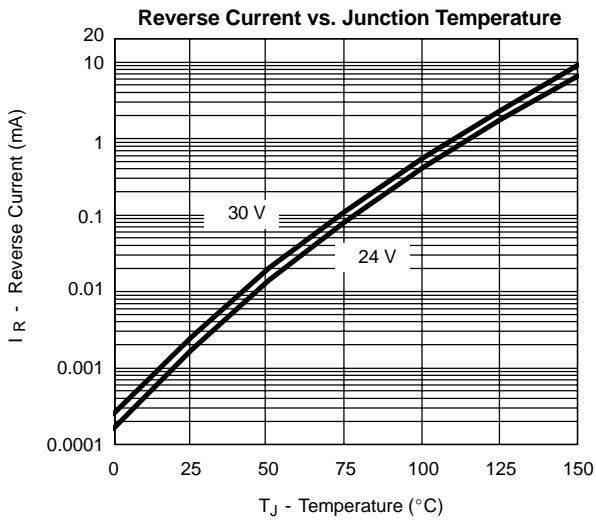

Copyright © Each Manufacturing Company.

All Datasheets cannot be modified without permission.

This datasheet has been download from :

[www.AllDataSheet.com](http://www.AllDataSheet.com)

100% Free DataSheet Search Site.

Free Download.

No Register.

Fast Search System.

[www.AllDataSheet.com](http://www.AllDataSheet.com)