



New Product

Si7882DP
Vishay Siliconix

N-Channel Reduced Q_g , Fast Switching MOSFET

PRODUCT SUMMARY		
V_{DS} (V)	$r_{DS(on)}$ (Ω)	I_D (A)
12	0.0055 @ $V_{GS} = 4.5$ V	22
	0.008 @ $V_{GS} = 2.5$ V	18

FEATURES

- TrenchFET® Power MOSFET
- New Low Thermal Resistance PowerPAK™ Package with Low 1.07-mm Profile
- PWM Optimized for High Efficiency

APPLICATIONS

- Point-of-Load Synchronous Rectifier
 - 5-V or 3.3-V BUS Step Down
 - Q_g Optimized for 500-kHz Operation
- Synchronous Buck, Shoot-Thru Resistant

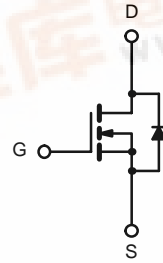
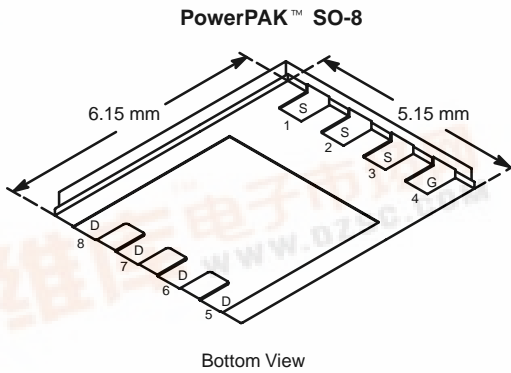

N-Channel MOSFET

ABSOLUTE MAXIMUM RATINGS ($T_A = 25^\circ\text{C}$ UNLESS OTHERWISE NOTED)					
Parameter	Symbol	10 secs	Steady State	Unit	
Drain-Source Voltage	V_{DS}	12		V	
Gate-Source Voltage	V_{GS}	± 8			
Continuous Drain Current ($T_J = 150^\circ\text{C}$) ^a	I_D	$T_A = 25^\circ\text{C}$	22	13	A
		$T_A = 70^\circ\text{C}$	18	11	
Pulsed Drain Current	I_{DM}	50			
Continuous Source Current (Diode Conduction) ^a	I_S	4.1	1.6		
Maximum Power Dissipation ^a	P_D	$T_A = 25^\circ\text{C}$	5	1.9	W
		$T_A = 70^\circ\text{C}$	3.2	1.2	
Operating Junction and Storage Temperature Range	T_J, T_{stg}	-55 to 150		$^\circ\text{C}$	

THERMAL RESISTANCE RATINGS					
Parameter	Symbol	Typical	Maximum	Unit	
Maximum Junction-to-Ambient (MOSFET) ^a	R_{thJA}	$t \leq 10$ sec	20	25	$^\circ\text{C/W}$
		Steady State	55	65	
Maximum Junction-to-Case (Drain)	R_{thJC}	2.0	2.6		

Notes:
a. Surface Mounted on 1" x 1" FR4 Board.

MOSFET SPECIFICATIONS (T_J = 25 °C UNLESS OTHERWISE NOTED)

Parameter	Symbol	Test Condition	Min	Typ	Max	Unit
Static						
Gate Threshold Voltage	V _{GS(th)}	V _{DS} = V _{GS} , I _D = 250 μA	0.6		1.4	V
Gate-Body Leakage	I _{GSS}	V _{DS} = 0 V, V _{GS} = ±8 V			±100	nA
Zero Gate Voltage Drain Current	I _{DSS}	V _{DS} = 9.6 V, V _{GS} = 0 V			1	μA
		V _{DS} = 9.6 V, V _{GS} = 0 V, T _J = 70 °C			5	
On-State Drain Current ^a	I _{D(on)}	V _{DS} ≥ 5 V, V _{GS} = 4.5 V	40			A
Drain-Source On-State Resistance ^a	r _{DS(on)}	V _{GS} = 4.5 V, I _D = 17 A		0.0045	0.0055	Ω
		V _{GS} = 2.5 V, I _D = 14 A		0.0065	0.008	
Forward Transconductance ^a	g _{fs}	V _{DS} = 6 V, I _D = 17 A		80		S
Diode Forward Voltage ^a	V _{SD}	I _S = 2.7 A, V _{GS} = 0 V		0.70	1.1	V
Dynamic^b						
Total Gate Charge	Q _g	V _{DS} = 6 V, V _{GS} = 4.5 V, I _D = 17 A		21	30	nC
Gate-Source Charge	Q _{gs}			4.6		
Gate-Drain Charge	Q _{gd}			3.5		
Turn-On Delay Time	t _{d(on)}	V _{DD} = 6 V, R _L = 6 Ω I _D = 1 A, V _{GEN} = 4.5 V, R _G = 6 Ω		28	42	ns
Rise Time	t _r			32	48	
Turn-Off Delay Time	t _{d(off)}			82	123	
Fall Time	t _f			35	53	
Source-Drain Reverse Recovery Time	t _{rr}	I _F = 2.7 A, di/dt = 100 A/μs		60	90	

Notes

- a. Pulse test; pulse width ≤ 300 μs, duty cycle ≤ 2%.
b. Guaranteed by design, not subject to production testing.

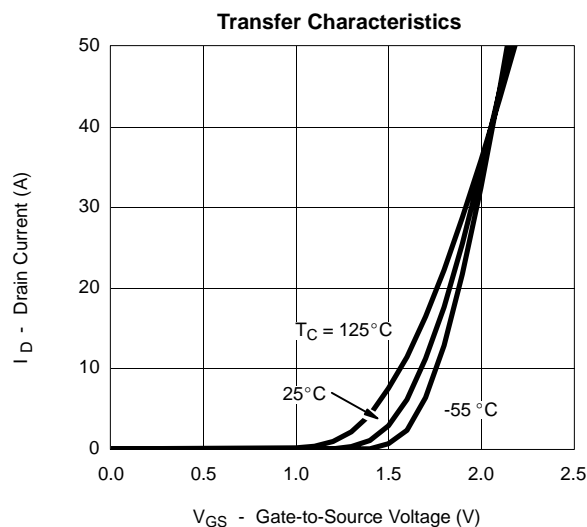
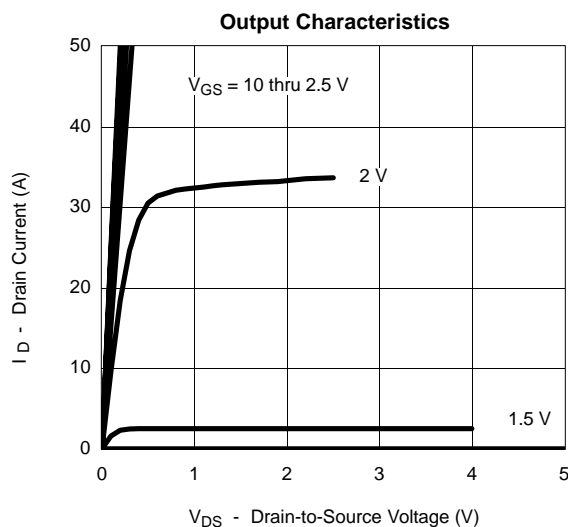
TYPICAL CHARACTERISTICS (25 °C UNLESS NOTED)



TYPICAL CHARACTERISTICS (25°C UNLESS NOTED)

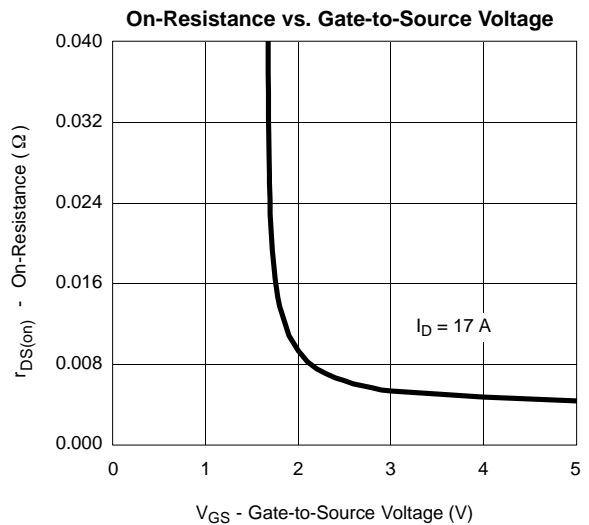
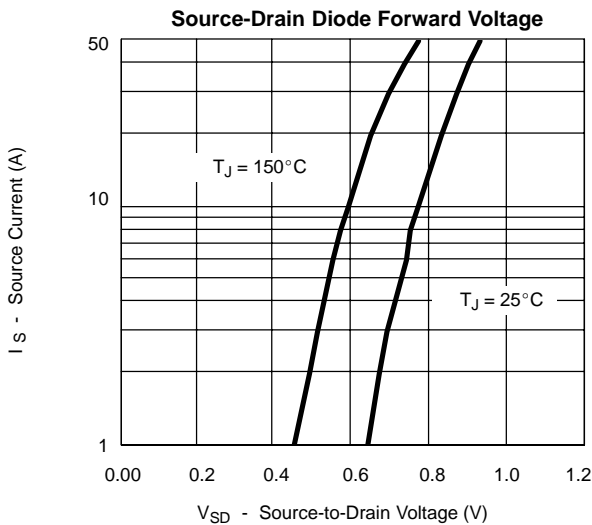
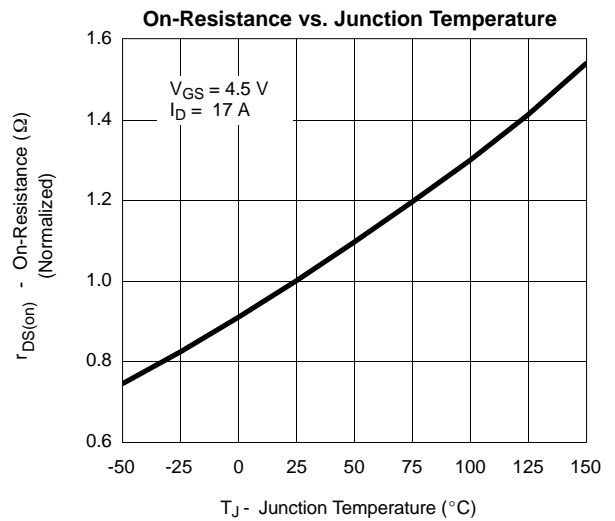
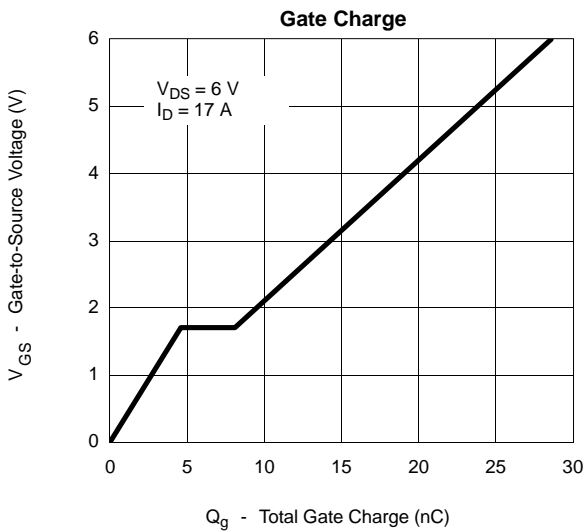
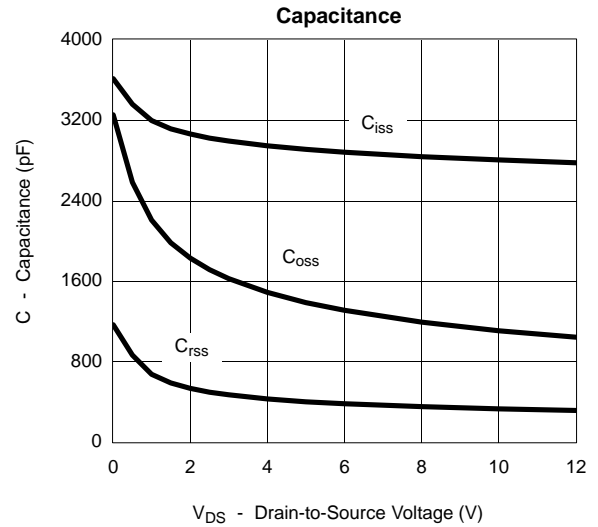
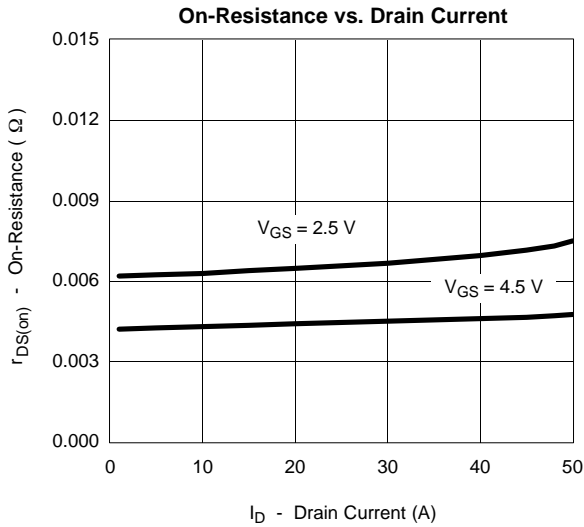



TYPICAL CHARACTERISTICS (25°C UNLESS NOTED)

