



New Product

Si7344DP
Vishay Siliconix

N-Channel 20-V (D-S) MOSFET

PRODUCT SUMMARY		
V _{DS} (V)	r _{DS(on)} (Ω)	I _D (A)
20	0.008 @ V _{GS} = 10 V	17
	0.012 @ V _{GS} = 4.5 V	14

FEATURES

- TrenchFET[®] Power MOSFET
- New Low Thermal Resistance PowerPAK[™] Package with Low 1.07-mm Profile
- PWM Optimized

APPLICATIONS

- DC/DC Conversion
 - Desktop
 - Server
- Synchronous Rectification

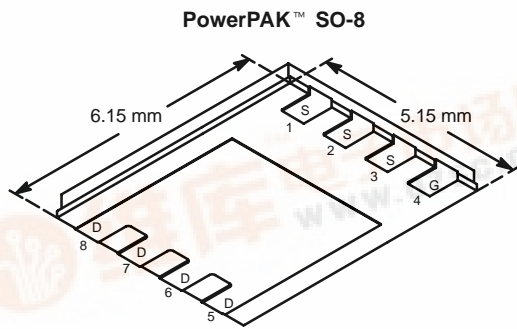

PowerPAK[™] SO-8

Bottom View

Ordering Information: Si7344DP-T1

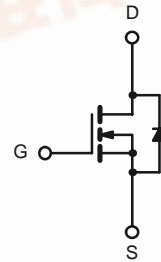

N-Channel MOSFET

ABSOLUTE MAXIMUM RATINGS (T _A = 25°C UNLESS OTHERWISE NOTED)					
Parameter		Symbol	10 secs	Steady State	Unit
Drain-Source Voltage		V _{DS}	20		V
Gate-Source Voltage		V _{GS}	±20		
Continuous Drain Current (T _J = 150°C) ^a	T _A = 25°C	I _D	17	11	A
	T _A = 70°C		14	9	
Pulsed Drain Current (10 μs Pulse Width)		I _{DM}	50		
Continuous Source Current (Diode Conduction) ^a		I _S	3.7	1.6	W
Maximum Power Dissipation ^a	T _A = 25°C	P _D	4.1	1.8	
	T _A = 70°C		2.6	1.1	
Operating Junction and Storage Temperature Range		T _J , T _{stg}	-55 to 150		°C

THERMAL RESISTANCE RATINGS					
Parameter		Symbol	Typical	Maximum	Unit
Maximum Junction-to-Ambient ^a	t ≤ 10 sec	R _{thJA}	22	30	°C/W
	Steady State		55	70	
Maximum Junction-to-Case (Drain)	Steady State	R _{thJC}	4.5	5.5	

Notes:
a. Surface Mounted on 1" x 1" FR4 Board.

SPECIFICATIONS (T_J = 25 °C UNLESS OTHERWISE NOTED)

Parameter	Symbol	Test Condition	Min	Typ	Max	Unit
Static						
Gate Threshold Voltage	V _{GS(th)}	V _{DS} = V _{GS} , I _D = 250 μA	0.8		2.1	V
Gate-Body Leakage	I _{GSS}	V _{DS} = 0 V, V _{GS} = ±20 V			±100	nA
Zero Gate Voltage Drain Current	I _{DSS}	V _{DS} = 16 V, V _{GS} = 0 V			1	μA
		V _{DS} = 16 V, V _{GS} = 0 V, T _J = 55 °C			5	
On-State Drain Current ^a	I _{D(on)}	V _{DS} ≥ 5 V, V _{GS} = 10 V	30			A
Drain-Source On-State Resistance ^a	r _{DS(on)}	V _{GS} = 10 V, I _D = 17 A		0.006	0.008	Ω
		V _{GS} = 4.5 V, I _D = 14 A		0.0095	0.012	
Forward Transconductance ^a	g _{fs}	V _{DS} = 6 V, I _D = 17 A		33		S
Diode Forward Voltage ^a	V _{SD}	I _S = 3.7 A, V _{GS} = 0 V		0.75	1.1	V
Dynamic^b						
Total Gate Charge	Q _g	V _{DS} = 10 V, V _{GS} = 4.5 V, I _D = 17 A		10	15	nC
Gate-Source Charge	Q _{gs}			3.3		
Gate-Drain Charge	Q _{gd}			3.1		
Gate Resistance	R _g			1.0		Ω
Turn-On Delay Time	t _{d(on)}	V _{DD} = 10 V, R _L = 10 Ω I _D ≅ 1 A, V _{GEN} = 10 V, R _G = 6 Ω		14	25	ns
Rise Time	t _r			15	25	
Turn-Off Delay Time	t _{d(off)}			40	65	
Fall Time	t _f			15	25	
Source-Drain Reverse Recovery Time	t _{rr}		I _F = 3.7 A, di/dt = 100 A/μs		35	

Notes

- a. Pulse test; pulse width ≤ 300 μs, duty cycle ≤ 2%.
 b. Guaranteed by design, not subject to production testing.

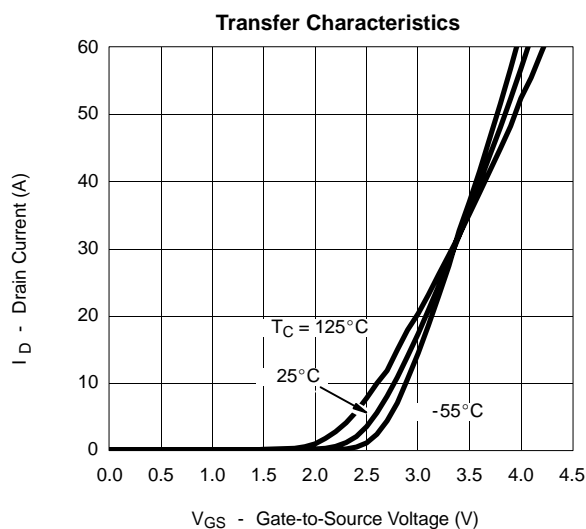
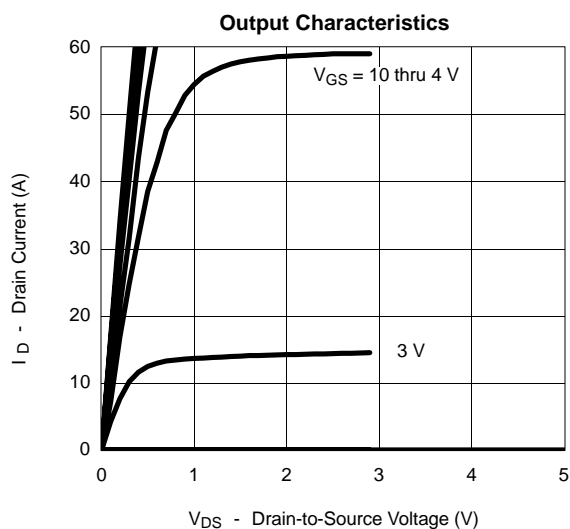
TYPICAL CHARACTERISTICS (25 °C UNLESS NOTED)



TYPICAL CHARACTERISTICS (25°C UNLESS NOTED)

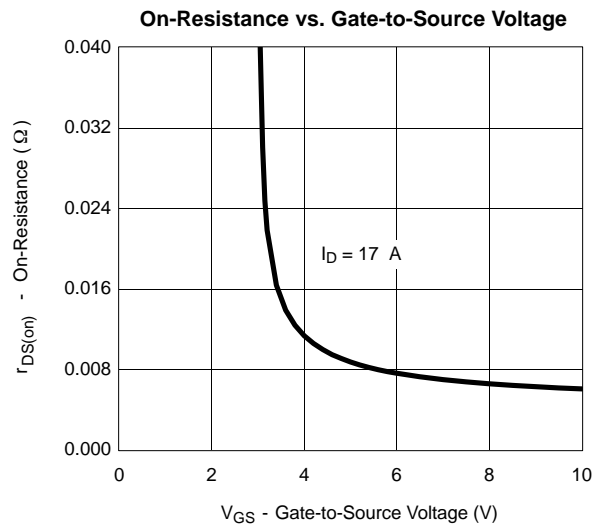
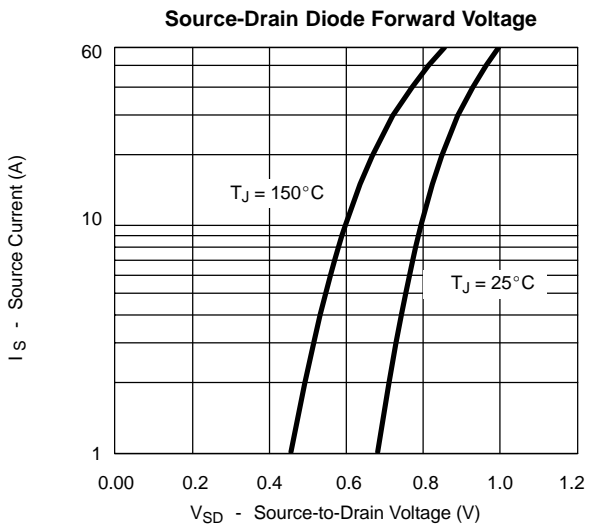
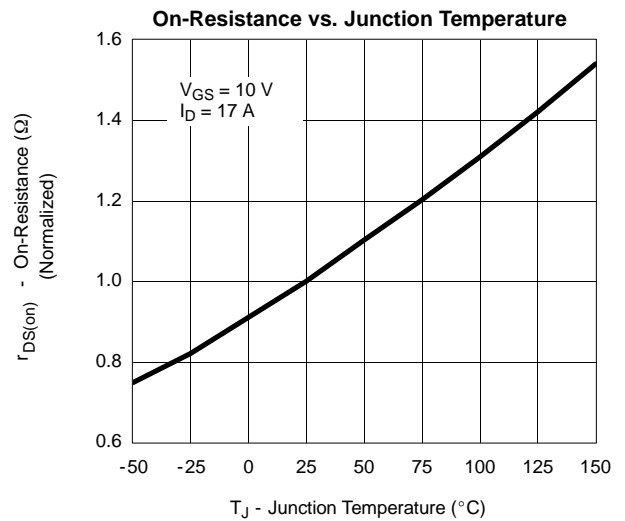
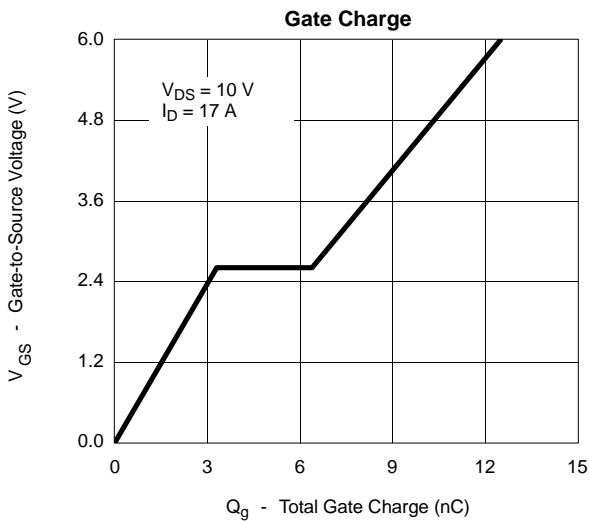
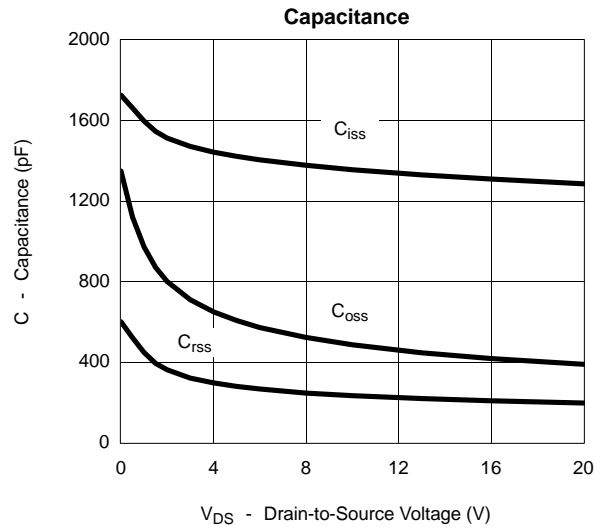
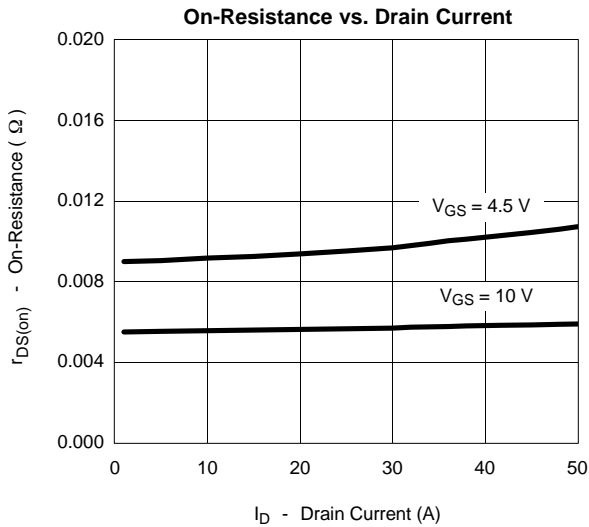



TYPICAL CHARACTERISTICS (25°C UNLESS NOTED)

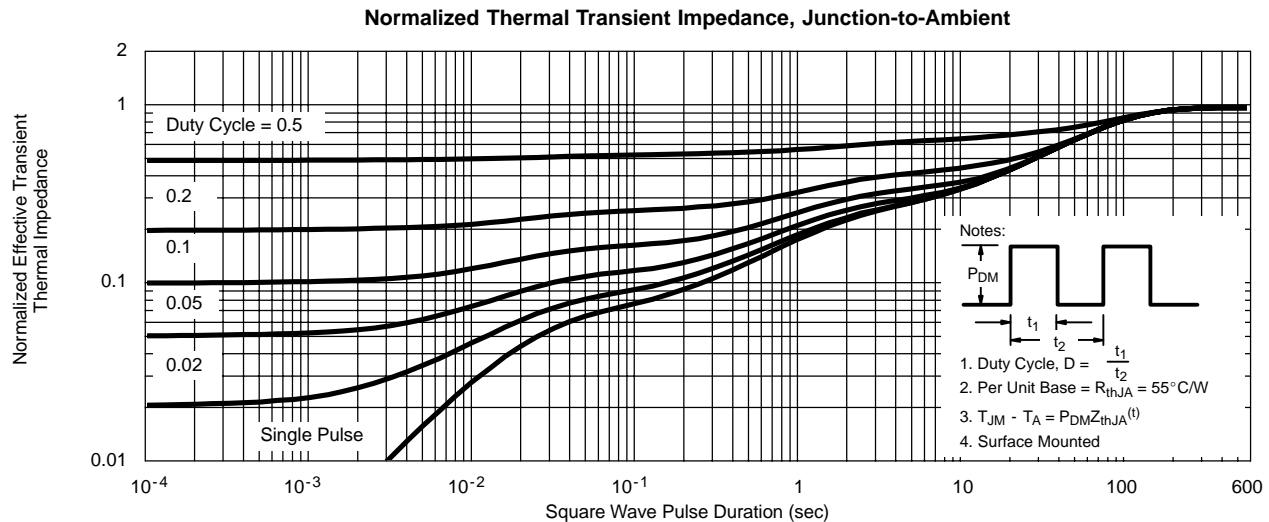
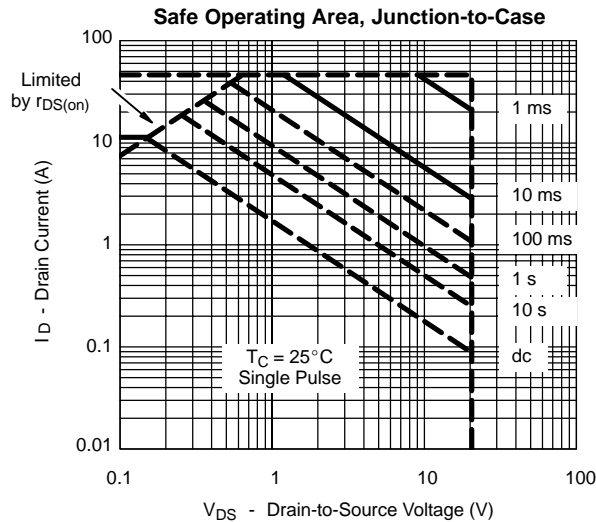
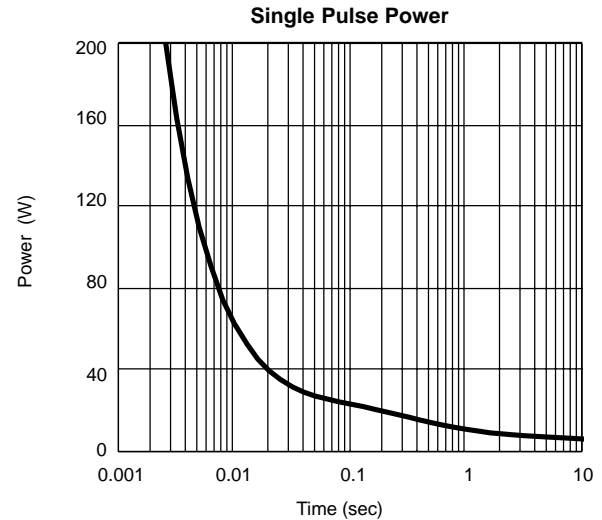
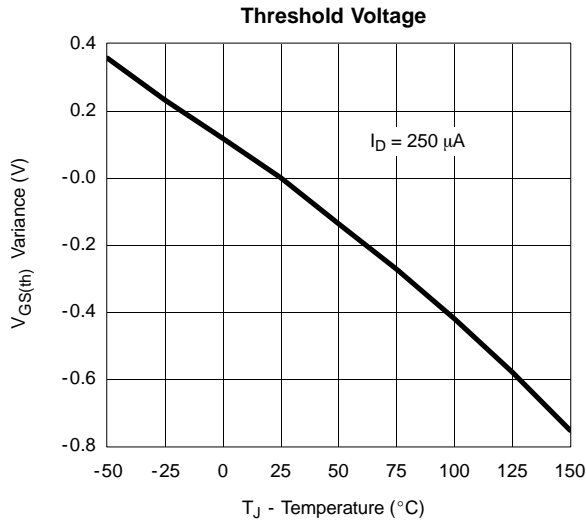



New Product

Si7344DP
Vishay Siliconix

TYPICAL CHARACTERISTICS (25°C UNLESS NOTED)

