

SEMICON INC

**SEMIKRON**

**Maximum Ratings**

Symbol	Conditions	Values	Units
$V_{CEVsus}$	$I_C = 1\text{ A}, V_{BE} = -2\text{ V}$	1200	V
$V_{CEV}$	$V_{BE} = -2\text{ V}$	1200	V
$V_{CBO}$	$I_E = 0$	1200	V
$V_{EBO}$	$I_C = 0$	7	V
$I_C$	D. C.	100	A
$I_{CM}$	$t_p = 1\text{ ms}$	200	A
$I_F = -I_C$		100	A
$I_B$		5	A
$P_{tot}$	$T_{case} = 25\text{ °C}; \text{ per darlington}$	800	W
$T_{vj}$		-40 ... +150	°C
$T_{stg}$		-40 ... +125	°C
$V_{isol}$	a. c. 50 Hz, r.m.s.	2500~	V

**Thermal Characteristics**

$R_{thjc}$	per darlington/per module	0,155/0,077	°C/W
$R_{thjc}$	per diode/per module	0,65/0,325	°C/W
$R_{thch}$	per 1/2 module/per module	0,075/0,038	°C/W

**Electrical Characteristics<sup>1)</sup>**

		min.	typ.	max.	
$I_{CEV}$	$V_{CE} = V_{CEV}, V_{BE} = -2\text{ V}$			2	mA
$I_{EBO}$	$I_C = 0, V_{BE} = -7\text{ V}$			400	mA
$V_{CEsat}^{2)}$	$I_C = 100\text{ A}, I_B = 2\text{ A}$			3	V
$V_{BEsat}^{2)}$	$I_C = 100\text{ A}, I_B = 2\text{ A}$			3,5	V
$h_{21E}^{2)}$	$I_C = 100\text{ A}, V_{CE} = 5\text{ V}$	75			

**Switching Characteristics for Resistive Load<sup>1)</sup>**

$t_{on}$	$I_C = 100\text{ A}$ $I_{B1} = -I_{B2} = 2\text{ A}$ $V_{CC} = 600\text{ V}$			3	µs
$t_s$				15	µs
$t_f$				3	µs

**Inverse Diode Characteristics<sup>1)</sup>**

$V_F = -V_{CE}$	$I_F = -I_C = 100\text{ A}$			1,8	V
$I_{FSM} = -I_{CP}$	$\sin 180^\circ, 10\text{ ms}$	1000			A
$I_{RM}$	$I_F = -I_C = 100\text{ A}, -di_F/dt = 100\text{ A}/\mu\text{s}$ $V_{BE} = -3\text{ V}, V_R = V_{CE} = 400\text{ V},$ $T_{vj} = 125\text{ °C}$			38	A
$Q_{rr}$					19

**Mechanical Data**

$M_1$	Case to heatsink	SI units	3	6	Nm
		US units	27	53	lb. in.
$M_2$	Busbars to terminals	SI units	2,5	5	Nm
		US units	22	44	lb. in.
w			420		g
Case			D 14		

**SEMTRANS® 3 NPN**

**Power Darlington Modules**

100 A, 1200 V  
SK 100 DB 120 D  
SK 100 DAL 120 D

T-33-35

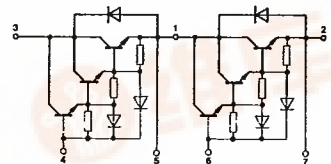
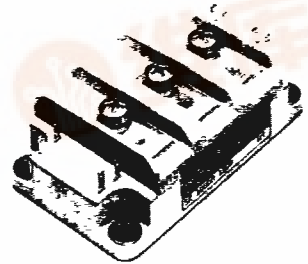

DB

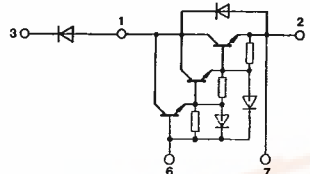

DAL

**Features**

- Isolated baseplate (ease of mounting of one or several modules on one heatsink)
- All electrical connections on top (ease of interconnecting of modules with busbars/PCB)
- Large clearances and creepage distances
- Parallel connected fast recovery inverse diode
- UL recognized, file no. 63 532

**Typical Applications**

- Switched mode power supplies
- DC servo and robot drives
- AC motor controls
- Brake choppers (DAL)

1)  $T_{case} = 25\text{ °C}$  unless otherwise stated  
2)  $t_p \leq 300\text{ µs}, D \leq 1,5\%$



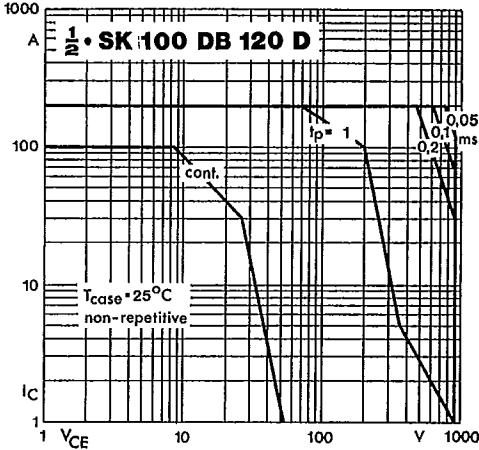

Fig. 1 Forward biased safe operating area (FBSOA)

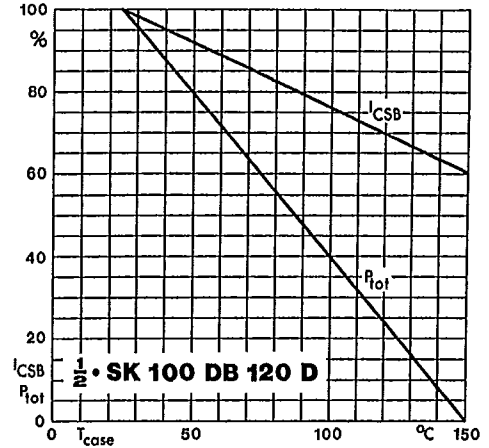

Fig. 2 Shifting the limits of the FBSOA with temperature

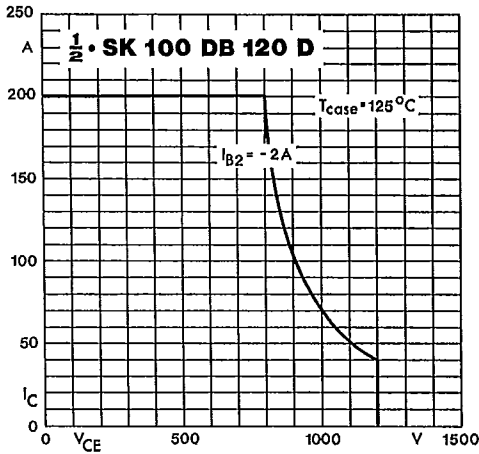

Fig. 3 Reverse biased safe operating area (RBSOA)

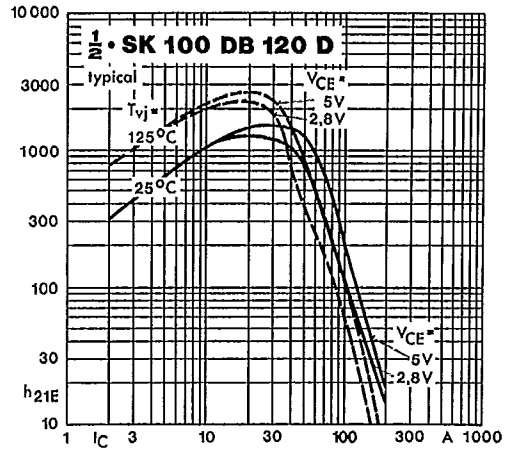

Fig. 4 Forward current transfer ratio vs. coll. current

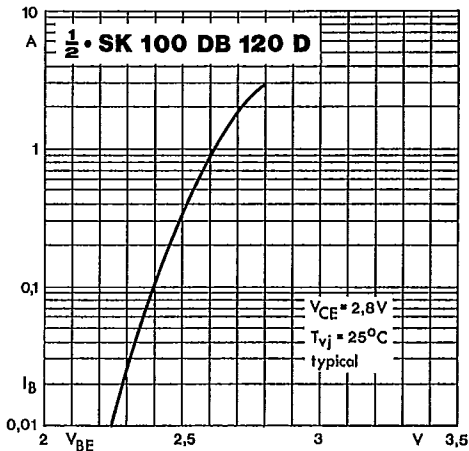

Fig. 5 Base current/voltage characteristic

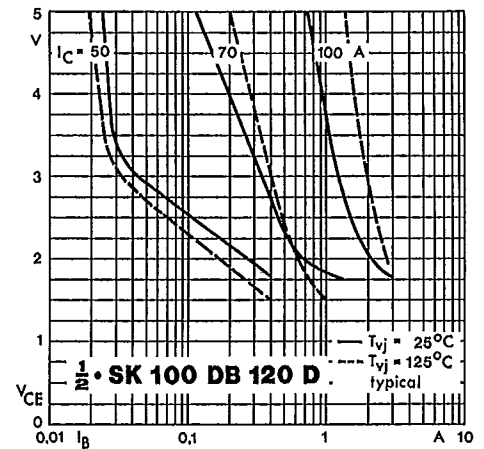

Fig. 6 Collector-emitter voltage vs. base current

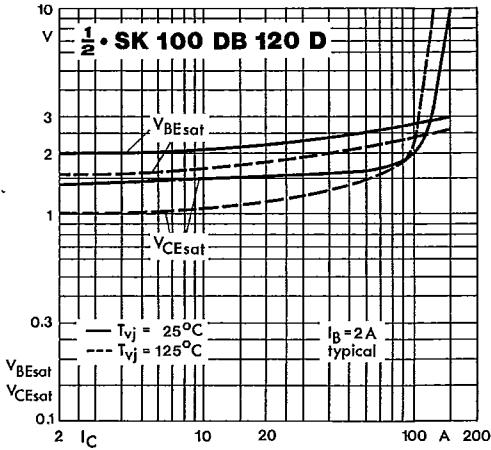

Fig. 7 Saturation voltages vs. collector current

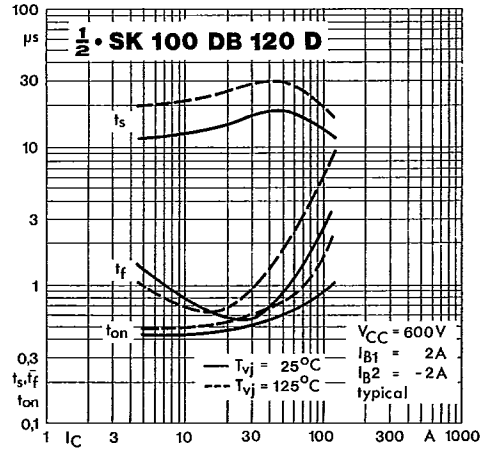

Fig. 8 Switching times vs. collector current

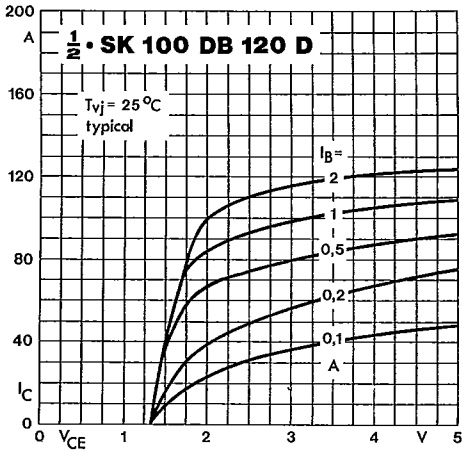

Fig. 9 Collector current/voltage characteristics

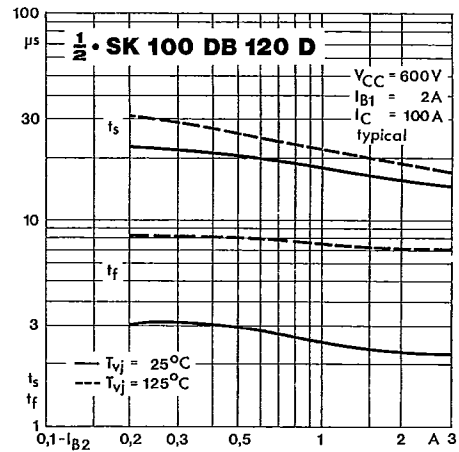

Fig. 10 Turn-off times vs. negative base current

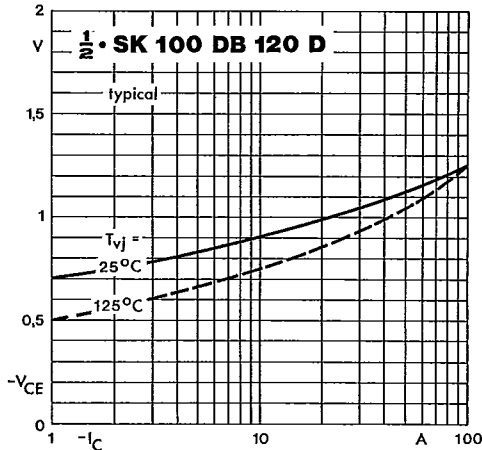

Fig. 11 Inverse diode forward characteristics

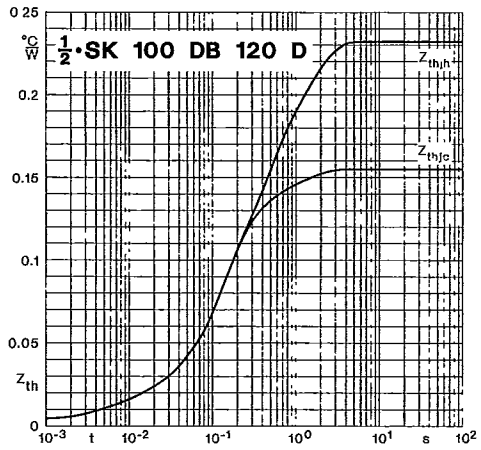

Fig. 12 Transient thermal impedance vs. time

51E D ■ 8136671 0003827 362 ■ SEKG

SEMIKRON INC

T-33-35

**SK 100 DB 120 D**

Case D 14

SEMITRANS® 3

UL recognized, file no. 63 532

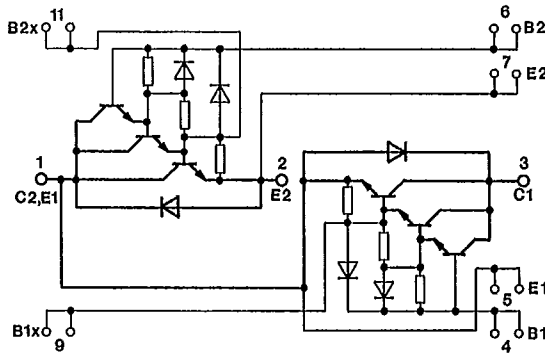
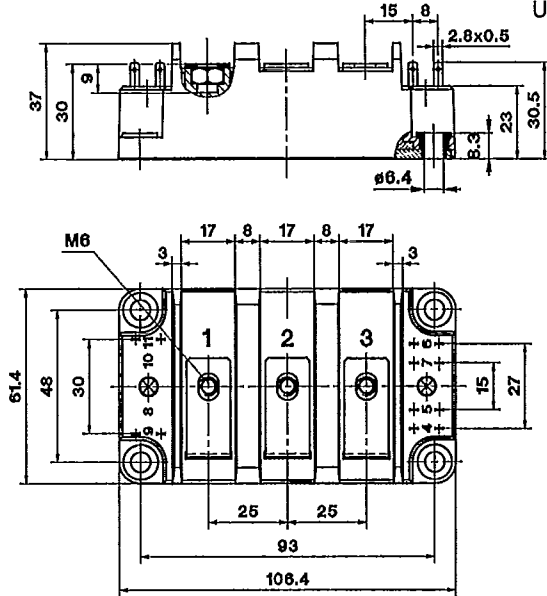

Dimensions in mm

**SK 100 DAL 120 D**

Case D 39

SEMITRANS® 3

UL recognized, file no. E 63 532

