

SK 15 GH 063

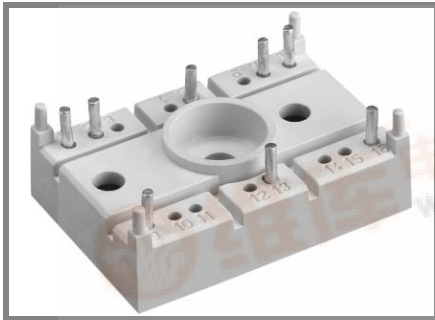

SEMITOP® 2

IGBT Module

SK 15 GH 063

Preliminary Data

Features

- Compact design
- One screw mounting
- Heat transfer and isolation through direct copper bonded aluminium oxide ceramic (DCB)
- N channel, homogeneous Silicon structure (NPT-Non punchthrough IGBT)
- High short circuit capability
- Low tail current with low temperature dependence
- UL recognized, file no. E 63532

Typical Applications

- Switching (not for linear use)
- Inverter
- Switched mode power supplies
- UPS

Absolute Maximum Ratings		T _s = 25 °C, unless otherwise specified	
Symbol	Conditions	Values	Units
IGBT			
V _{CES}		600	V
V _{GES}		± 20	V
I _C	T _s = 25 (80) °C;	20 (14)	A
I _{CM}	t _p < 1 ms; T _s = 25 (80) °C;	40 (28)	A
T _j		- 40 ... + 150	°C
Inverse/Freewheeling CAL diode			
I _F	T _s = 25 (80) °C;	22 (15)	A
I _{FM} = - I _{CM}	t _p < 1 ms; T _s = 25 (80) °C;	44 (30)	A
T _j		- 40 ... + 150	°C
T _{stg}		- 40 ... + 125	°C
T _{sol}	Terminals, 10 s	260	°C
V _{isol}	AC 50 Hz, r.m.s. 1 min. / 1 s	2500 / 3000	V

Characteristics		T _s = 25 °C, unless otherwise specified			
Symbol	Conditions	min.	typ.	max.	Units
IGBT					
V _{CE(sat)}	I _C = 15 A, T _j = 25 (125) °C		2,1 (2,2)	2,7 (2,8)	V
V _{GE(th)}	V _{CE} = V _{GE} ; I _C = 0,0004 A	4,5	5,5	6,5	V
C _{ies}	V _{CE} = 25 V; V _{GE} = 0 V; 1 MHz		0,8		nF
R _{th(j-s)}	per IGBT			1,9	K/W
	per module				K/W
under following conditions:					
t _{d(on)}	V _{CC} = 300 V, V _{GE} = ± 15 V		35		ns
t _r	I _C = 15 A, T _j = 125 °C		50		ns
t _{d(off)}	R _{Gon} = R _{Goff} = 68 Ω		250		ns
t _f			20		ns
E _{on} + E _{off}	Inductive load		1,11		mJ
Inverse/Freewheeling CAL diode					
V _F = V _{EC}	I _F = 10 A; T _j = 25 (125) °C		1,45 (1,4)	1,7 (1,7)	V
V _(TO)	T _j = (125) °C		(0,85)	(0,9)	V
r _T	T _j = (125) °C		(55)	(80)	mΩ
R _{th(j-s)}				1,2	K/W
under following conditions:					
I _{RRM}	I _F = 10 A; V _R = 300 V		13		A
Q _{rr}	di _F /dt = -200 A/μs		1,5		μC
E _{off}	V _{GE} = 0 V; T _j = 125 °C		0,45		mJ
Mechanical data					
M1	mounting torque			2	Nm
w			19		g
Case	SEMITOP® 2		T 5		

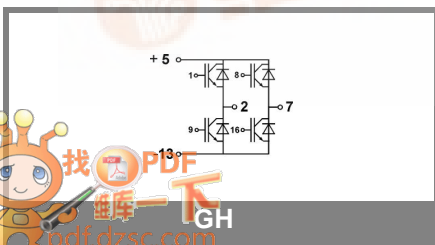

SK 15 GH 063

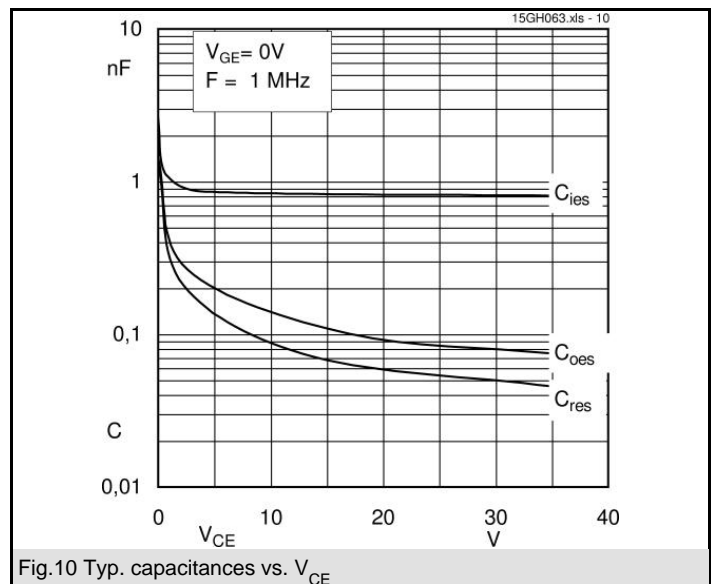
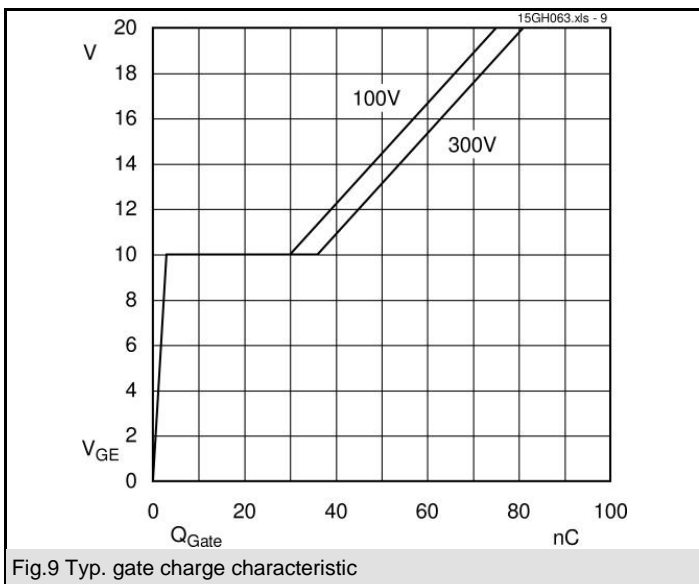
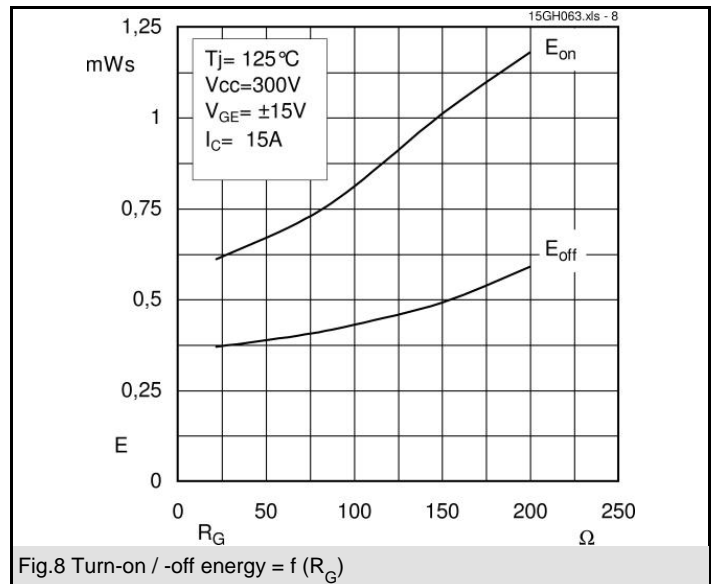
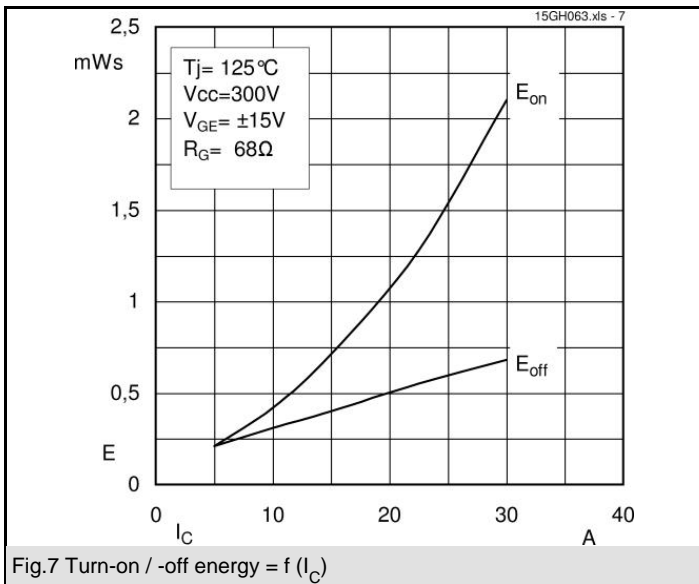
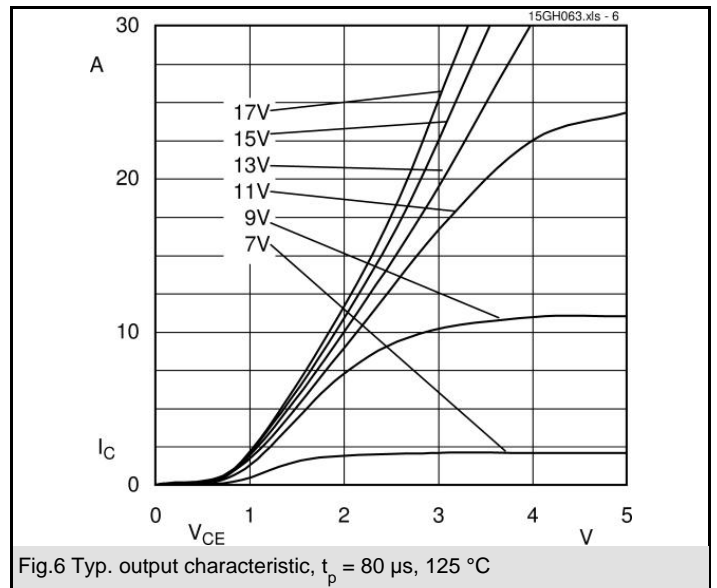
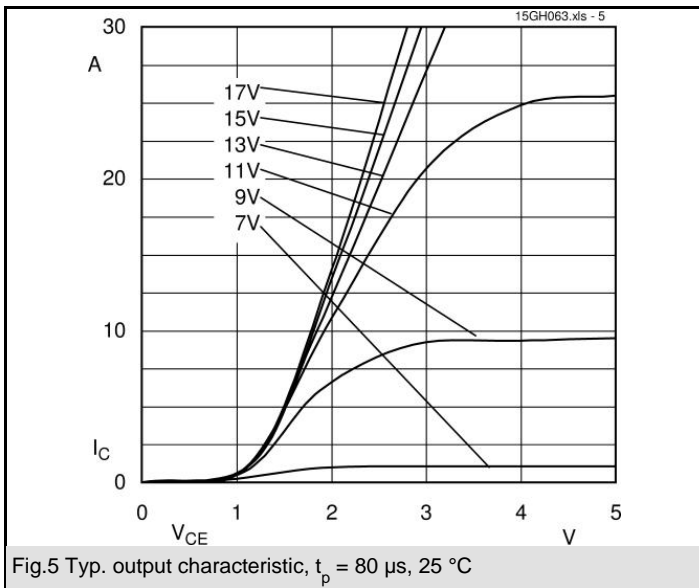

SK 15 GH 063

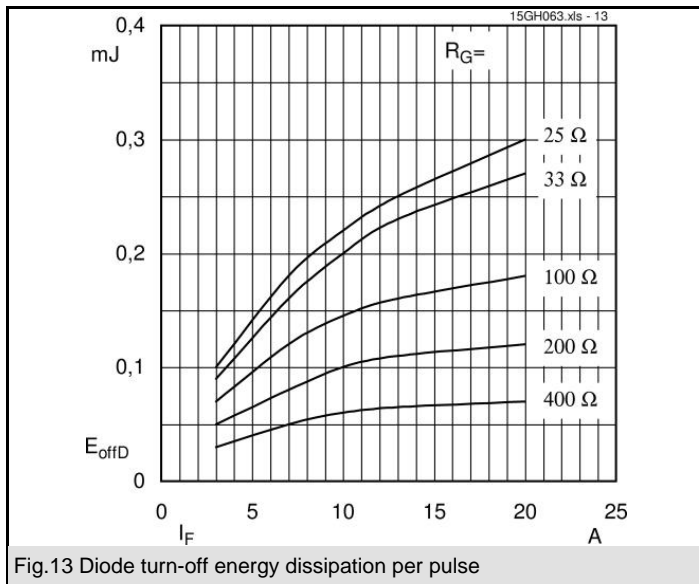
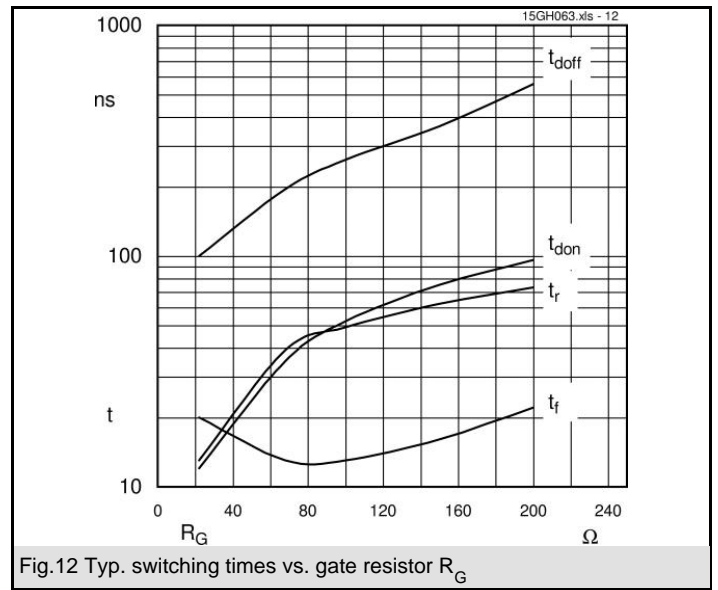
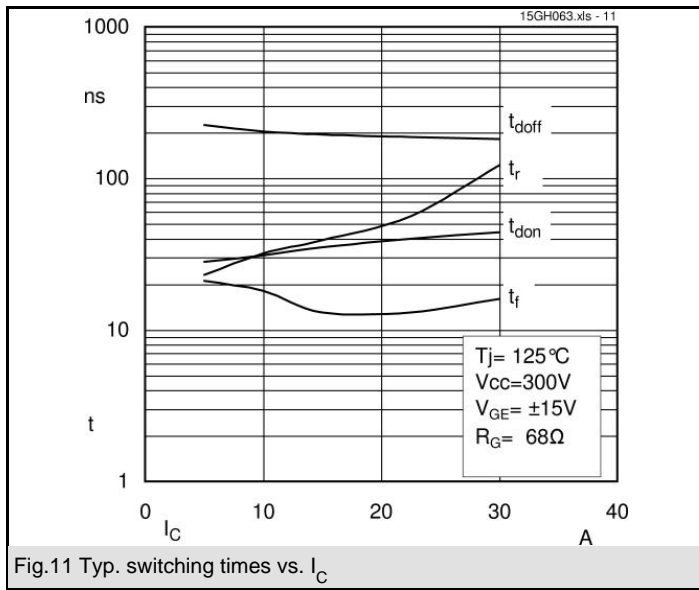

SK 15 GH 063

UL Recognized
File no. E 63532

Dimensions in mm

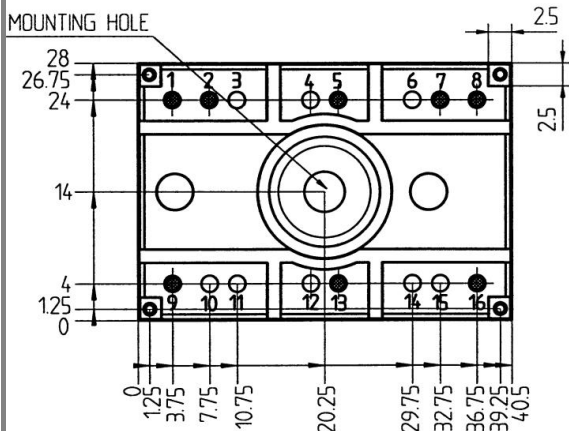
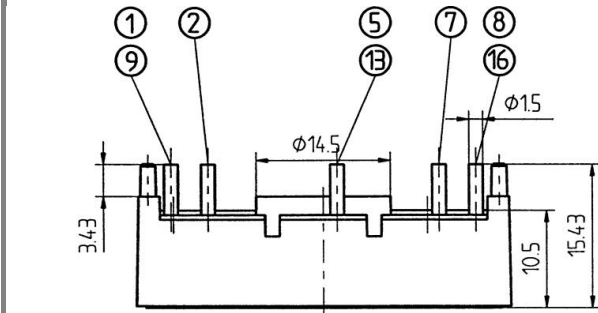

SUGGESTED HOLEDIAMETER FOR THE SOLDER PINS AND THE MOUNTING PINS IN THE PCB: 2 mm

Case T5

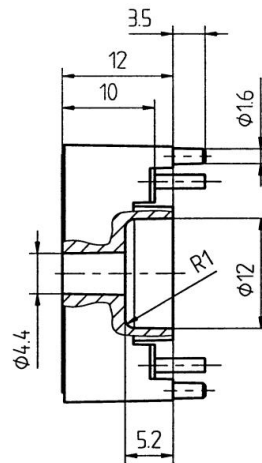
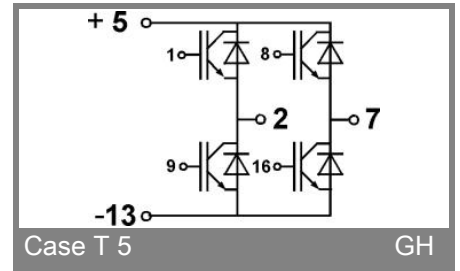

This is an electrostatic discharge sensitive device (ESDS), international standard IEC 60747-1, Chapter IX.

This technical information specifies semiconductor devices but promises no characteristics. No warranty or guarantee expressed or implied is made regarding delivery, performance or suitability.

Copyright © Each Manufacturing Company.

All Datasheets cannot be modified without permission.

This datasheet has been download from :

www.AllDataSheet.com

100% Free DataSheet Search Site.

Free Download.

No Register.

Fast Search System.

www.AllDataSheet.com