



# SK12 THRU SK1B

**SURFACE MOUNT SCHOTTKY BARRIER RECTIFIER**  
**Reverse Voltage - 20 to 100 Volts**  
**Forward Current - 1.0 Ampere**

## Features

- Schottky barrier rectifier
- Guardring protection
- Low forward voltage
- Reverse energy tested
- High current capability
- Extremely low thermal resistance

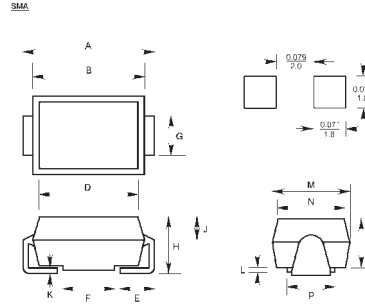

## Mechanical Data

- **Case:** SMA molded plastic body
- **Polarity:** Color band denotes cathode end
- **Mounting Position:** Any
- **Weight:** 0.004 ounce, 0.11 gram

DIM	DIMENSIONS				Note
	Inches		mm		
A	0.216	0.226	5.48	5.74	
B	0.176	0.182	4.48	4.63	
C	0.094	0.100	2.40	2.55	
D	0.170	0.176	4.33	4.48	
E	0.039	0.055	1.00	1.40	
F	0.060	0.081	2.03	2.07	
G	0.068	0.083	1.72	2.10	
H	0.112	0.118	2.85	3.00	
J	0.057	-	1.44	-	
K	-	0.018	-	0.45	
L	0.016	-	0.40	-	
M	0.109	0.115	2.77	2.93	
N	0.105	0.107	2.67	2.73	
P	0.078	0.081	2.00	2.05	

## Maximum Ratings and Electrical Characteristics @25°C unless otherwise specified

	Symbols	SK12	SK13	SK14	SK15	SK16	SK17	SK18	SK19	SK1B	Units
Maximum repetitive peak reverse voltage	$V_{RRM}$	20	30	40	50	60	70	80	90	100	Volts
Maximum RMS voltage	$V_{RMS}$	14	21	28	35	42	49	56	63	70	Volts
Maximum DC blocking voltage	$V_{DC}$	20	30	40	50	60	70	80	90	100	Volts
Average forward current at $T_J=90^\circ\text{C}$	$I_{F(AV)}$	1.0									Amp
Peak forward surge current 8.3mS single half sine-wave	$I_{FSM}$	50.0									Amps
Maximum instantaneous forward voltage at $I_{FM}=1.0A, T_J=25^\circ\text{C}$ (Note 1)	$V_F$	0.45	0.55	0.60	0.72			0.80		Volts	
Maximum DC reverse current at rated DC blocking voltage $T_J=25^\circ\text{C}$	$I_R$	0.5									mA
Typical junction capacitance (Note 2)	$C_J$	230	50								pF
Maximum thermal resistance	$R_{\theta JL}$	15									$^\circ\text{C}/\text{W}$
Operating and storage temperature range	$T_J, T_{STG}$	-65 to +175									$^\circ\text{C}$

### Notes:

- (1) Pulse test: Pulse width 300uSec, duty cycle 2%.
- (2) Measured at 1.0MHz and applied reverse voltage of 4.0 volts

# RATINGS AND CHARACTERISTIC CURVES

Figure 1  
Typical Forward Characteristics

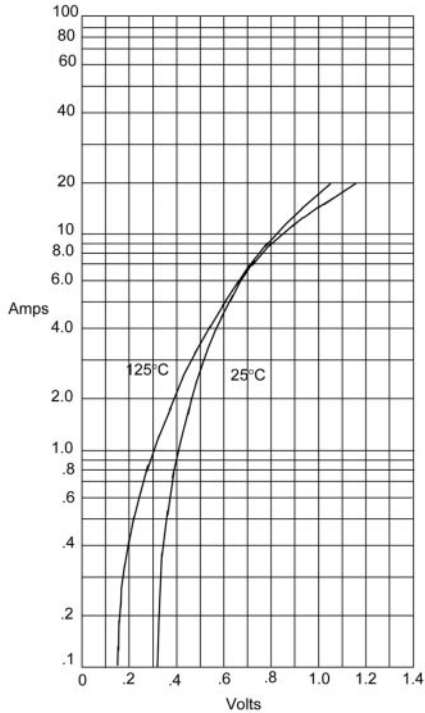

Instantaneous Forward Current - Amperes versus  
Instantaneous Forward Voltage - Volts

Figure 2  
Typical Reverse Characteristics

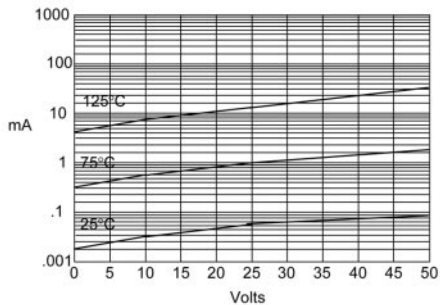

Typical Reverse Current - mA versus  
Reverse Voltage - Volts

Figure 3  
Typical Junction Capacitance

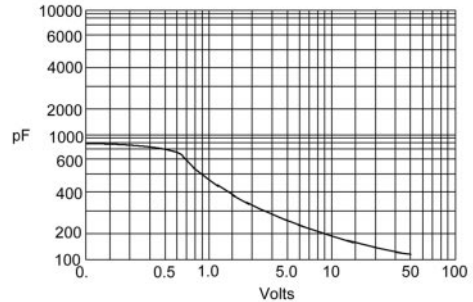

Junction Capacitance - pF versus  
Reverse Voltage - Volts

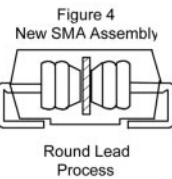

SK12

# RATINGS AND CHARACTERISTIC CURVES

Figure 1  
Typical Forward Characteristics

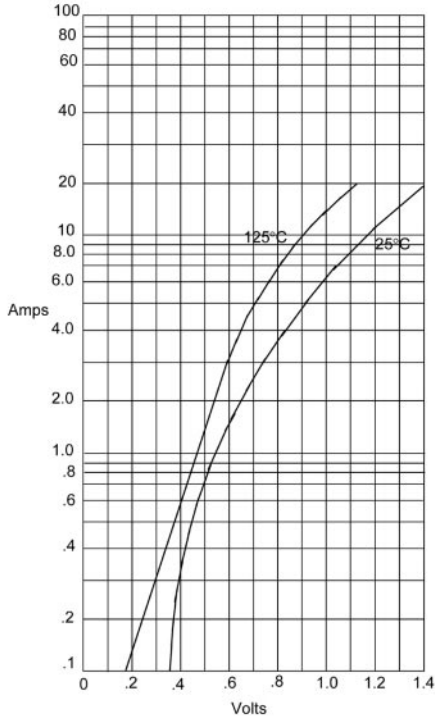

Instantaneous Forward Current - Amperes versus  
Instantaneous Forward Voltage - Volts

Figure 2  
Typical Reverse Characteristics

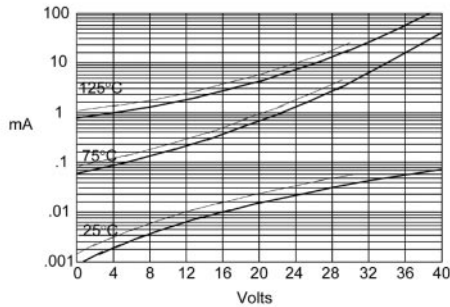

Typical Reverse Current - mA versus  
Reverse Voltage - Volts

Figure 3  
Typical Junction Capacitance

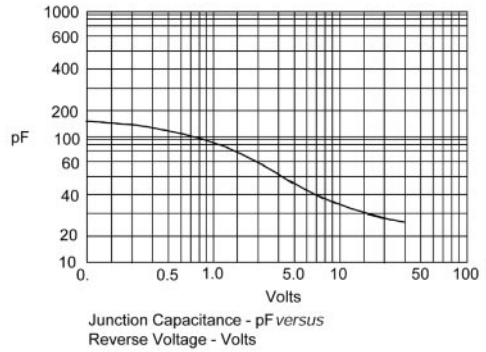

Junction Capacitance - pF versus  
Reverse Voltage - Volts

Figure 4  
New SMA Assembly

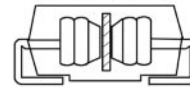

Round Lead  
Process

SK13 ———  
SK14 ———

Copyright © Each Manufacturing Company.

All Datasheets cannot be modified without permission.

This datasheet has been download from :

[www.AllDataSheet.com](http://www.AllDataSheet.com)

100% Free DataSheet Search Site.

Free Download.

No Register.

Fast Search System.

[www.AllDataSheet.com](http://www.AllDataSheet.com)