

# SKM 121AR

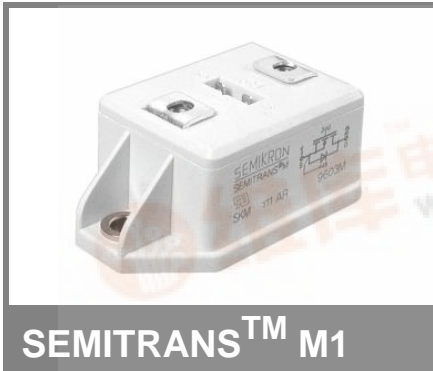

Absolute Maximum Ratings		T <sub>c</sub> = 25 °C, unless otherwise specified	
Symbol	Conditions	Values	Units
V <sub>DS</sub>		200	V
I <sub>D</sub>	T <sub>s</sub> = 25 (80) °C	130 (95)	A
I <sub>DM</sub>	1 ms	390	A
V <sub>GS</sub>		± 20	V
T <sub>vj</sub> ' (T <sub>stg</sub> )		- 40 ... + 150 (125)	°C
V <sub>isol</sub>	AC, 1 min.	2500	V
Inverse diode			
I <sub>F</sub> = - I <sub>S</sub>		130	A
I <sub>FM</sub> = - I <sub>SM</sub>		390	A

## Power MOSFET Modules

### SKM 121AR

#### Features

- N Channel, enhancement mode
- Avalanche characteristics
- Short internal connections avoid oscillations
- Isolated copper baseplates
- All electrical connections on top for easy busbaring
- Large clearance (10mm) and creepage distances (13mm)
- UL recognized, file no. E 63 532

#### Typical Applications

- Switched mode power supplies
- DC servo and robot drives
- DC choppers
- UPS equipment
- Plasma cutting
- Not suitable for linear amplification

Characteristics		T <sub>c</sub> = 25 °C, unless otherwise specified			
Symbol	Conditions	min.	typ.	max.	Units
V <sub>(BR)DSS</sub>	V <sub>GS</sub> = 0 V, I <sub>D</sub> = 0,25 mA	200			V
V <sub>GS(th)</sub>	V <sub>GS</sub> = V <sub>DS</sub> , I <sub>D</sub> = 1 mA	2,1	3	4	V
I <sub>DSS</sub>	V <sub>GS</sub> = 0 V, V <sub>DS</sub> = 200 V, T <sub>j</sub> = 25 (125) °C		50 (300)	250 (1000)	µA
I <sub>GSS</sub>	V <sub>GS</sub> = 20 V, V <sub>DS</sub> = 0 V		10	100	nA
R <sub>DS(on)</sub>	V <sub>GS</sub> = 10 V, I <sub>D</sub> = 80 A		18	20	mΩ
g <sub>fs</sub>	V <sub>DS</sub> = 25 V, I <sub>D</sub> = 80 A	60	75		S
C <sub>CHC</sub>	V <sub>GS</sub> = 0, V <sub>DS</sub> = 25 V, f = 1 MHz			160	pF
C <sub>iss</sub>			10	13	nF
C <sub>oss</sub>			3	4,5	nF
C <sub>rss</sub>			0,7	1	nF
L <sub>DS</sub>				20	nH
t <sub>d(on)</sub>	V <sub>DD</sub> = 100 V, I <sub>D</sub> = 80 A,		60		ns
t <sub>r</sub>	V <sub>GS</sub> = 10 V, R <sub>G</sub> = 3,3 Ω		60		ns
t <sub>d(off)</sub>			240		ns
t <sub>f</sub>			70		ns
Inverse diode					
V <sub>SD</sub>	I <sub>F</sub> = 260 A; V <sub>GS</sub> = 0 V		1,05	1,4	V
t <sub>rr</sub>	T <sub>j</sub> = 25 (150) °C		400		ns
Q <sub>rr</sub>	T <sub>j</sub> = 25 °C		4,3		µC
I <sub>rr</sub>	T <sub>j</sub> = °C				A
Thermal characteristics					
R <sub>th(f-c)</sub>	per MOSFET			0,18	K/W
R <sub>th(c-s)</sub>	M <sub>s</sub> , surface 10 µm, per module			0,05	K/W
Mechanical data					
M <sub>s</sub>	to heatsink (M6)	4		5	Nm
M <sub>t</sub>	for terminals (M5)	2,5		3,5	Nm
w				130	g

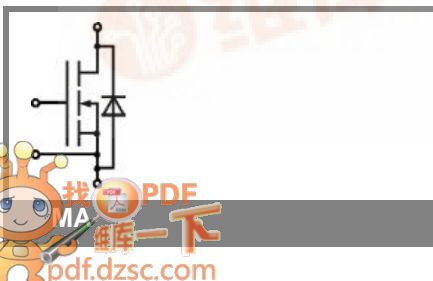

# SKM 121AR

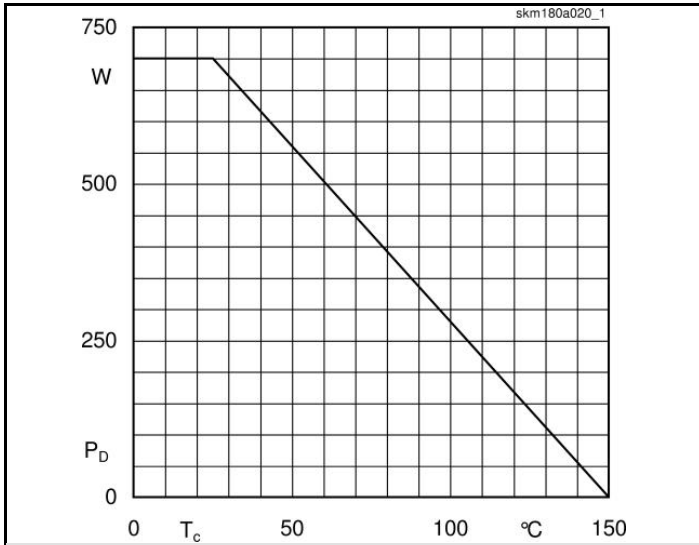

Fig. 1 Rated power dissipation vs. temperature

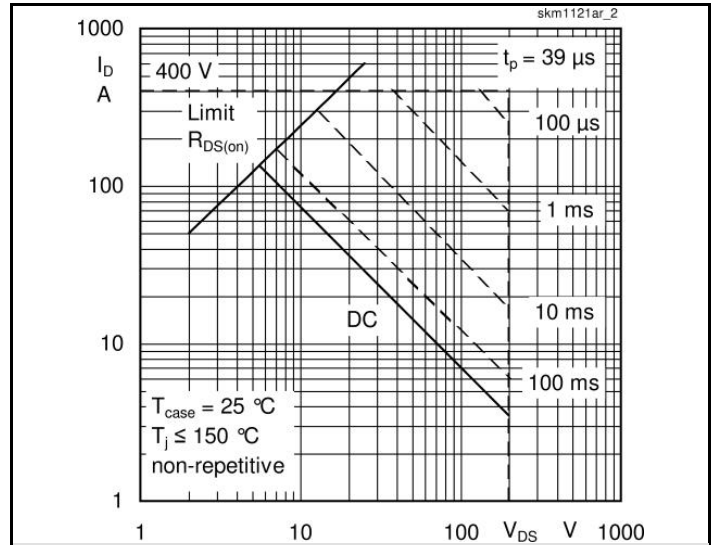

Fig. 2 Maximum safe operating area

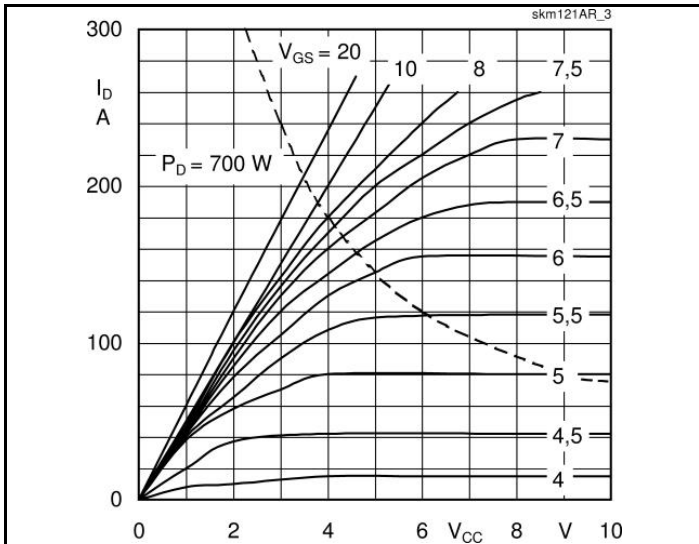

Fig. 3 Output characteristic

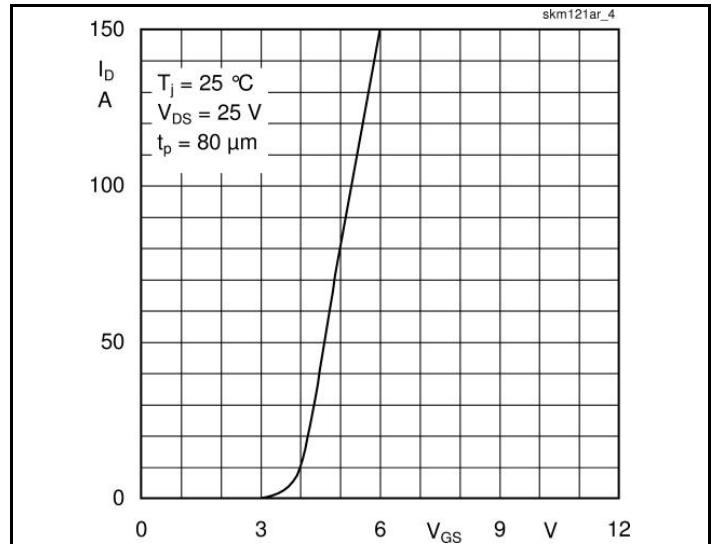

Fig. 4 Transfer characteristic

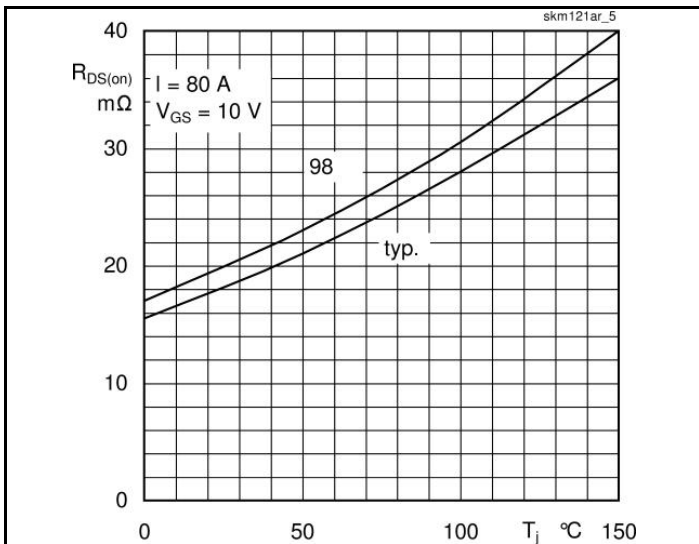

Fig. 5 On-resistance vs. temperature

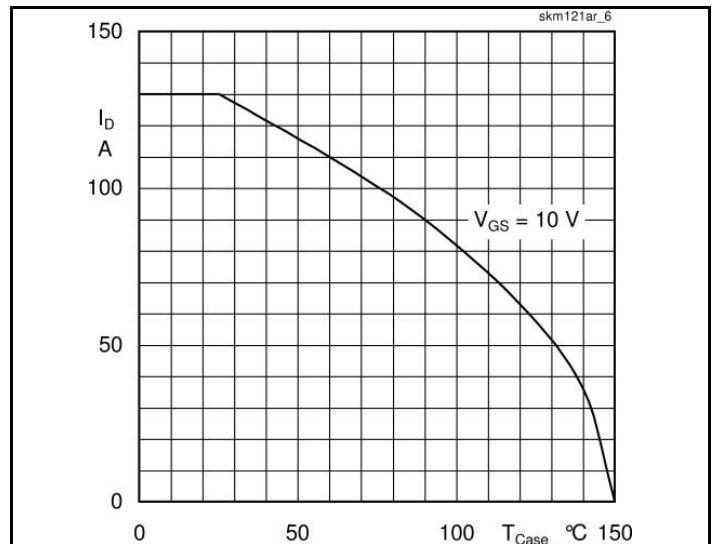
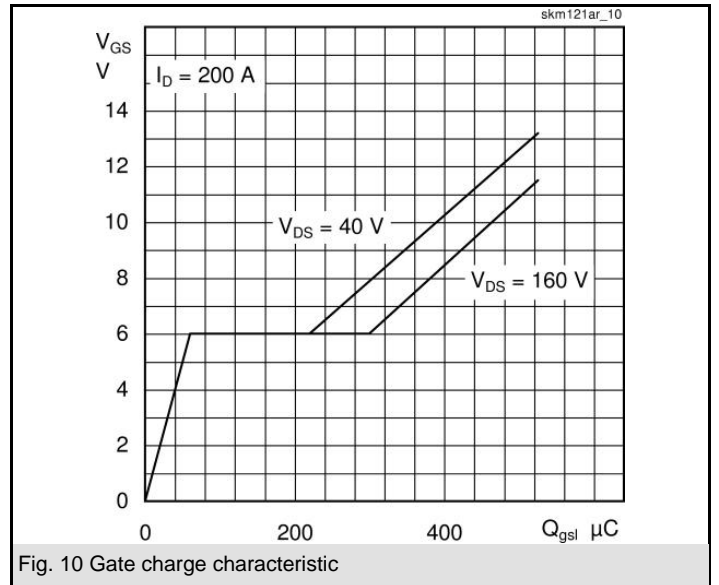
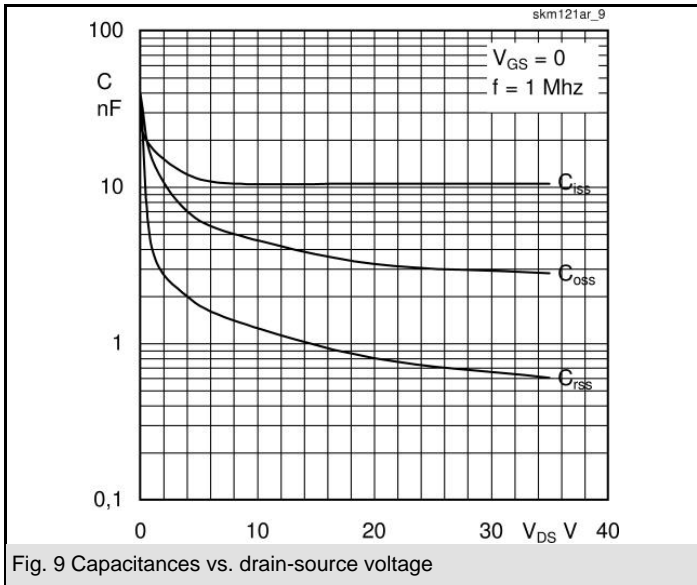
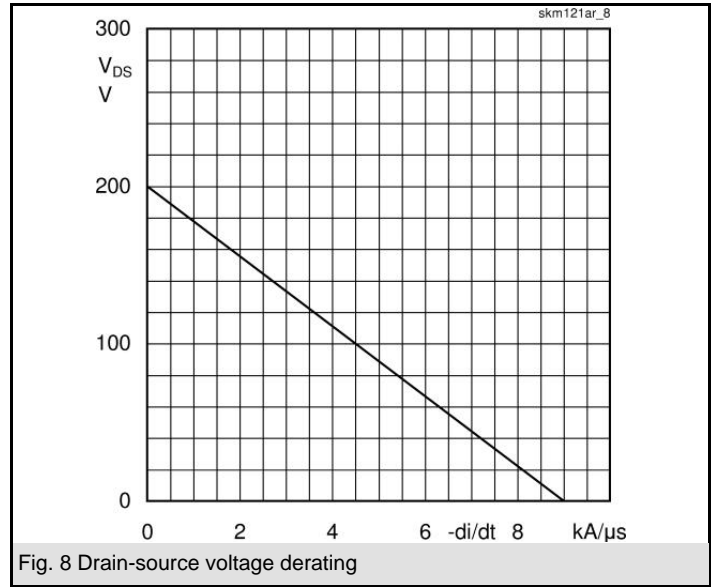
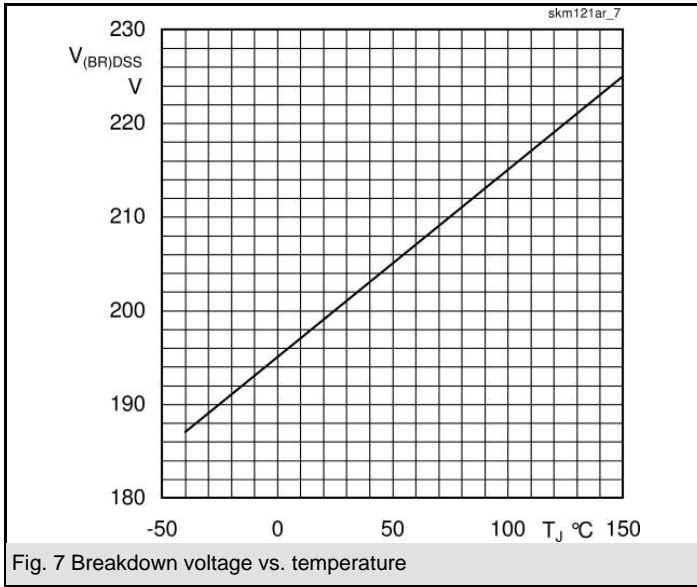

Fig. 6 Rated current vs. temperature

# SKM 121AR



# SKM 121AR

UL Recognized  
File no. E 63 532

Dimensions in mm

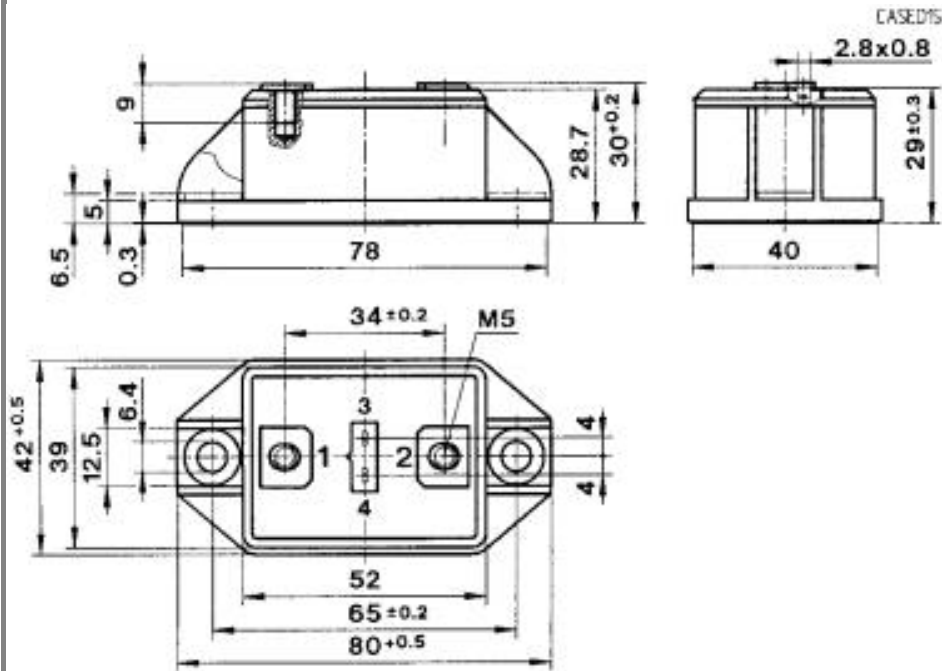

Case D 15

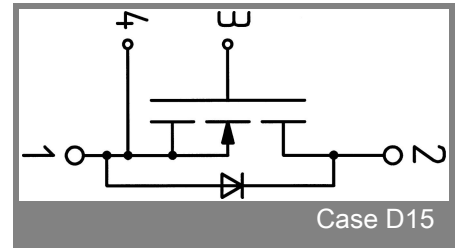

Case D15

This is an electrostatic discharge sensitive device (ESDS), international standard IEC 60747-1, Chapter IX.

This technical information specifies semiconductor devices but promises no characteristics. No warranty or guarantee expressed or implied is made regarding delivery, performance or suitability.

Copyright © Each Manufacturing Company.

All Datasheets cannot be modified without permission.

This datasheet has been download from :

[www.AllDataSheet.com](http://www.AllDataSheet.com)

100% Free DataSheet Search Site.

Free Download.

No Register.

Fast Search System.

[www.AllDataSheet.com](http://www.AllDataSheet.com)