

# SKM 145GB124DN

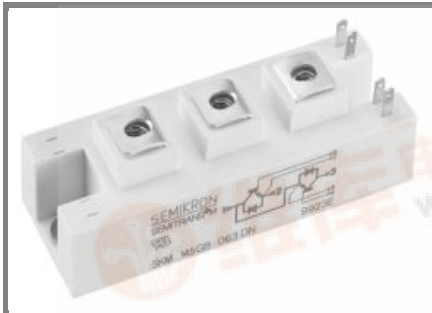

## SEMITRANS™ 2N

### Low Loss IGBT Modules

SKM 145GB124DN  
SKM 145GAL124DN

### Features

- N channel, homogeneous Si - structure (NPT - Non punch-trough IGBT)
- High short circuit capability, self limiting to  $6 \times I_{Cnom}$
- Fast & soft inverse CAL diodes
- Without hard mould
- Large clearance (10 mm) and creepage distances ( 20 mm)

### Typical Applications

- Switching (not for linear use)
- Switched mode power supplies
- DC servo and robot supplies
- Inverters
- DC choppers
- AC motor speed control
- UPS
- General power switching applications

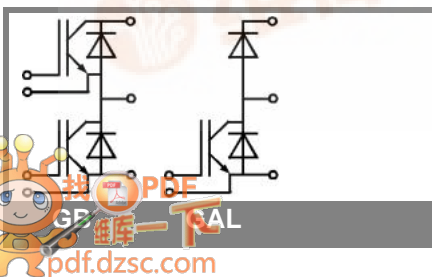

Absolute Maximum Ratings		$T_c = 25\text{ }^\circ\text{C}$ , unless otherwise specified		
Symbol	Conditions	Values	Units	
<b>IGBT</b>				
$V_{CES}$		1200	V	
$I_C$	$T_c = 25\text{ (80) }^\circ\text{C}$	190 (130)	A	
$I_{CRM}$	$t_p = 1\text{ ms}$	200	A	
$V_{GES}$		$\pm 20$	V	
$T_{vj}$ , ( $T_{stg}$ )	$T_{OPERATION} \leq T_{stg}$	- 40 ... + 150 (125)	$^\circ\text{C}$	
$V_{isol}$	AC, 1 min.	2500	V	
<b>Inverse diode</b>				
$I_F$	$T_c = 25\text{ (80) }^\circ\text{C}$	120 (95)	A	
$I_{FRM}$	$t_p = 1\text{ ms}$	200	A	
$I_{FSM}$	$t_p = 10\text{ ms}$ ; sin.; $T_j = 150\text{ }^\circ\text{C}$	1100	A	
<b>Freewheeling diode</b>				
$I_F$	$T_c = 25\text{ (80) }^\circ\text{C}$	120 (95)	A	
$I_{FRM}$	$t_p = \text{ms}$	200	A	
$I_{FSM}$	$t_p = \text{ms}$ ; ; $T_j = \text{ }^\circ\text{C}$	1100	A	

Characteristics		$T_c = 25\text{ }^\circ\text{C}$ , unless otherwise specified			
Symbol	Conditions	min.	typ.	max.	Units
<b>IGBT</b>					
$V_{GE(th)}$	$V_{GE} = V_{CE}$ ; $I_C = 4\text{ mA}$	4,5	5,5	6,5	V
$I_{CES}$	$V_{GE} = 0$ ; $V_{CE} = V_{CES}$ ; $T_j = 25\text{ (125) }^\circ\text{C}$		0,1	0,3	mA
$V_{CE(TO)}$	$T_j = 25\text{ (125) }^\circ\text{C}$		1,1 (1,1)	1,25 (1,25)	V
$r_{CE}$	$V_{GE} = 15\text{ V}$ ; $T_j = 25\text{ (125) }^\circ\text{C}$		10 (13)	12 (16)	m $\Omega$
$V_{CE(sat)}$	$I_{Cnom} = 100\text{ A}$ ; $V_{GE} = 15\text{ V}$ ; chip level		2,1 (2,4)	2,45 (2,85)	V
$C_{ies}$	under following conditions		6,5	8,5	nF
$C_{oes}$	$V_{GE} = 0$ ; $V_{CE} = 25\text{ V}$ ; $f = 1\text{ MHz}$		1	1,5	nF
$C_{res}$			0,5	0,6	nF
$L_{CE}$				25	nH
$R_{CC'+EE'}$	res.; terminal-chip $T_c = \text{ }^\circ\text{C}$				m $\Omega$
$t_{d(on)}$	$V_{CC} = 600\text{ V}$ ; $I_{Cnom} = 100\text{ A}$		110		ns
$t_r$	$R_{Gon} = R_{Goff} = 8\text{ }^\circ\Omega$ ; $T_j = 125\text{ }^\circ\text{C}$		50		ns
$t_{d(off)}$	$V_{GE} = \pm 15\text{ V}$		470		ns
$t_f$			60		ns
$E_{on} (E_{off})$			14 (13)		mJ
<b>Inverse diode</b>					
$V_F = V_{EC}$	$I_{Fnom} = 100\text{ A}$ ; $V_{GE} = 0\text{ V}$ ; $T_j = 25\text{ (125) }^\circ\text{C}$		2 (1,8)	2,5	V
$V_{(TO)}$	$T_j = 25\text{ (125) }^\circ\text{C}$		1,1	1,2	V
$r_T$	$T_j = 25\text{ (125) }^\circ\text{C}$		9	13	m $\Omega$
$I_{RRM}$	$I_{Fnom} = 100\text{ A}$ ; $T_j = 125\text{ ( ) }^\circ\text{C}$		100		A
$Q_{rr}$	$di/dt = 2600\text{ A}/\mu\text{s}$		15		$\mu\text{C}$
$E_{rr}$	$V_{GE} = 0\text{ V}$		5,4		mJ
<b>FWD</b>					
$V_F = V_{EC}$	$I_F = 100\text{ A}$ ; $V_{GE} = 0\text{ V}$ ; $T_j = 25\text{ (125) }^\circ\text{C}$		2 (1,8)	2,5	V
$V_{(TO)}$	$T_j = 25\text{ (125) }^\circ\text{C}$		1,1	1,2	V
$r_T$	$T_j = 25\text{ (125) }^\circ\text{C}$		9	13	m $\Omega$
$I_{RRM}$	$I_F = 100\text{ A}$ ; $T_j = 125\text{ ( ) }^\circ\text{C}$		100		A
$Q_{rr}$	$di/dt = 2600\text{ A}/\mu\text{s}$		15		$\mu\text{C}$
$E_{rr}$	$V_{GE} = 0\text{ V}$		5,4		mJ
<b>Thermal characteristics</b>					
$R_{th(j-c)}$	per IGBT			0,16	K/W
$R_{th(j-c)D}$	per Inverse Diode			0,32	K/W
$R_{th(j-c)FD}$	per FWD			0,32	K/W
$R_{th(c-s)}$	per module			0,05	K/W
<b>Mechanical data</b>					
$M_s$	to heatsink M6	3		5	Nm
$M_t$	to terminals M5	2,5		5	Nm
w				160	g

# SKM 145GB124DN

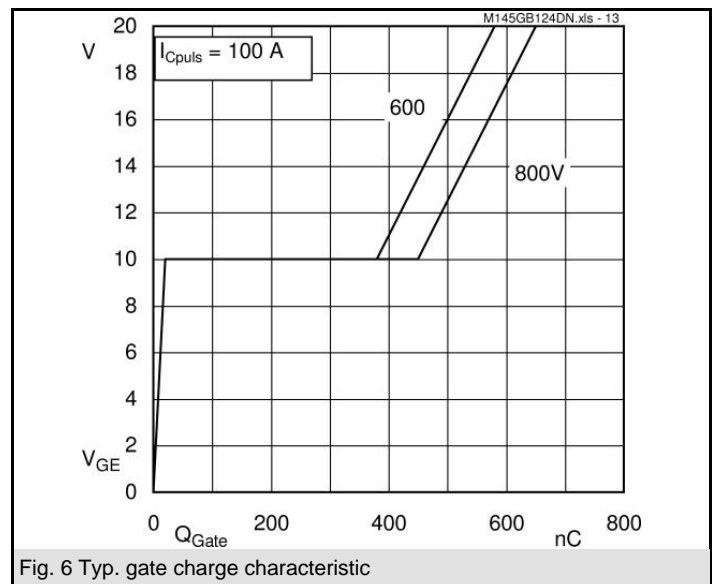
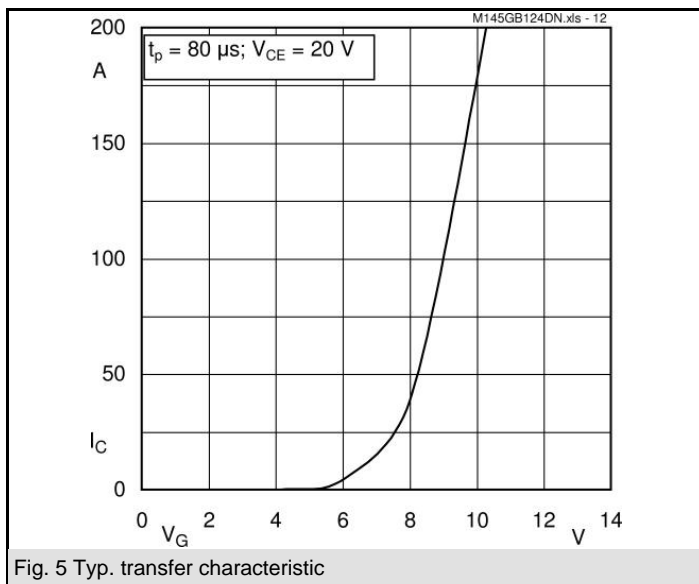
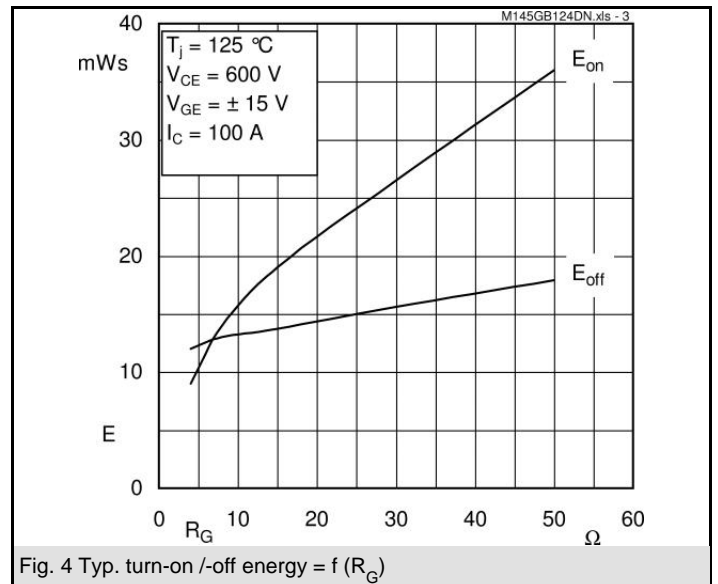
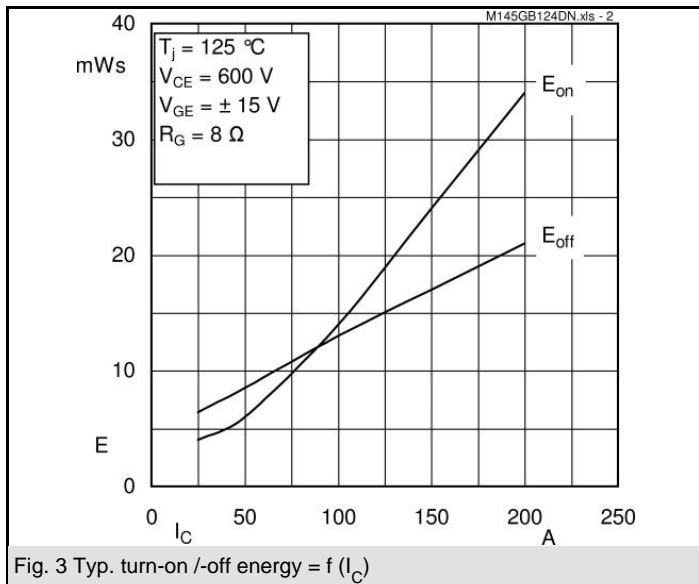
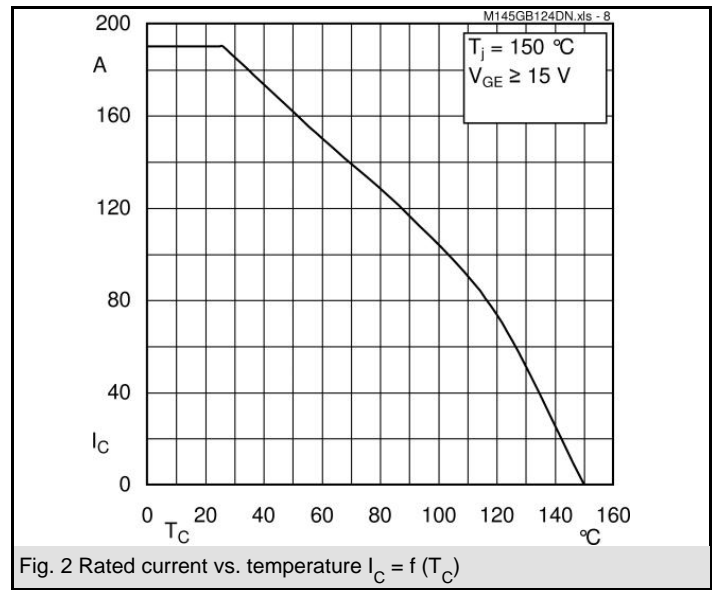
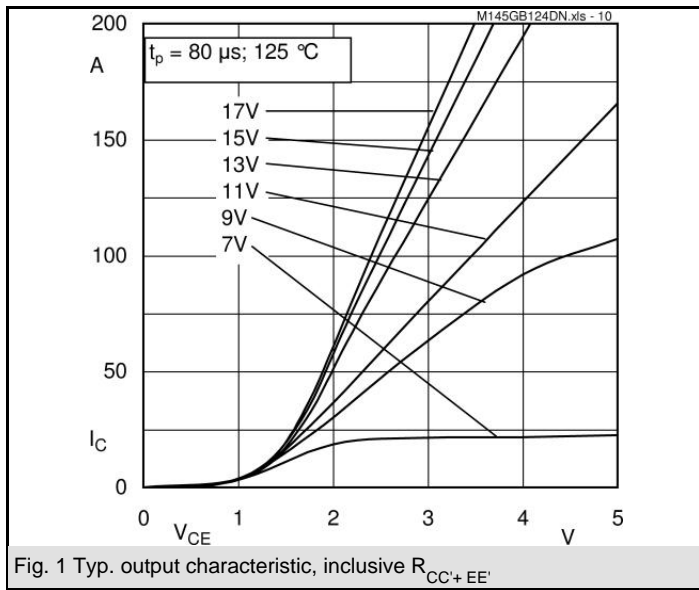

# SKM 145GB124DN

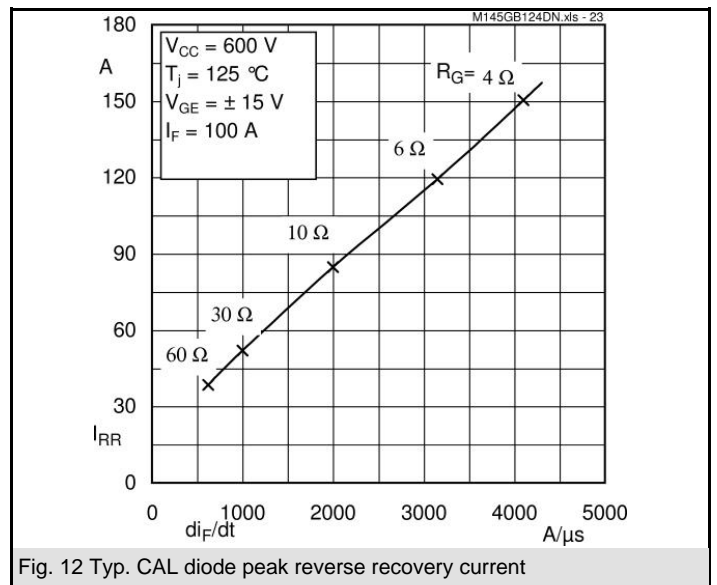
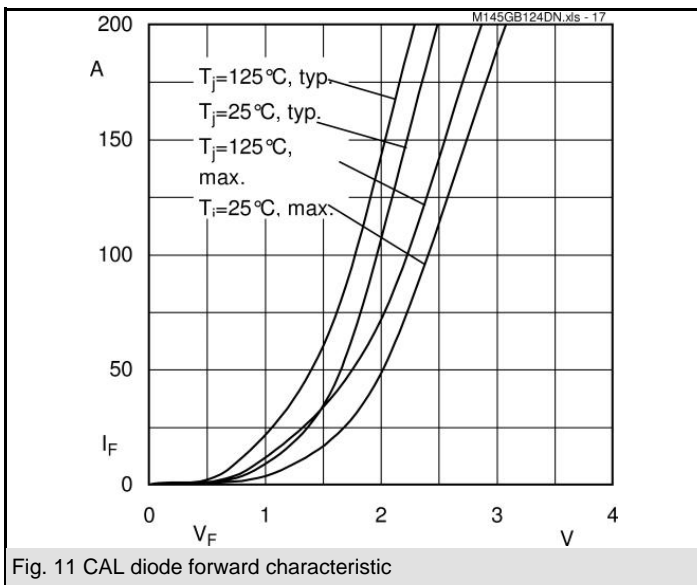
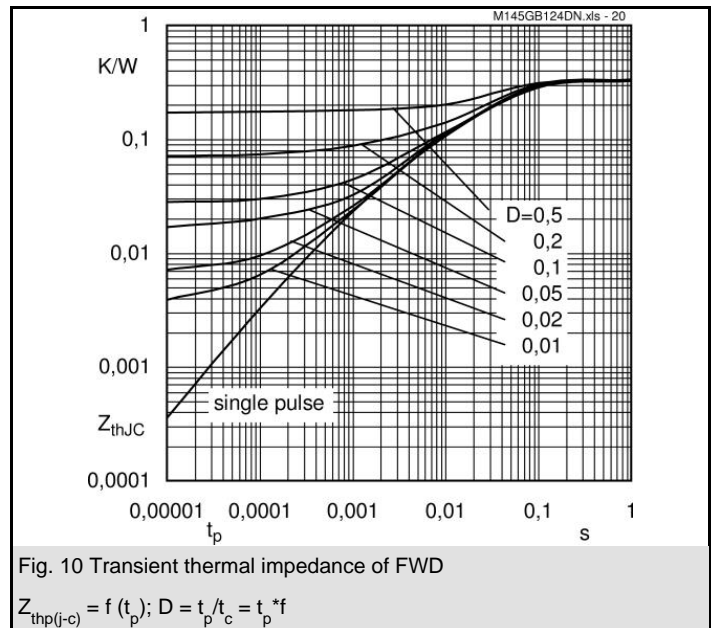
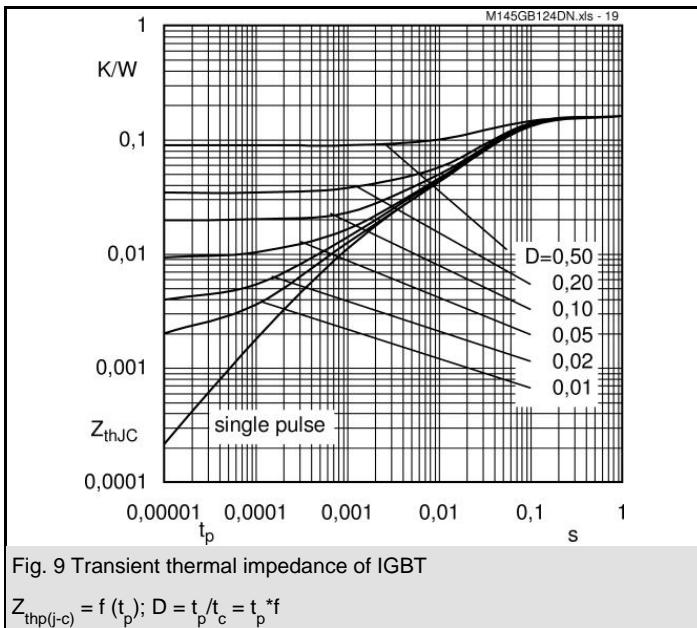
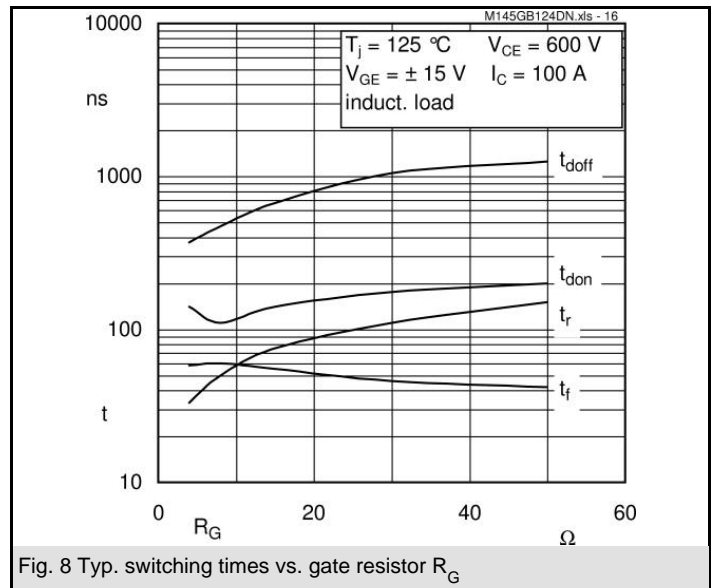
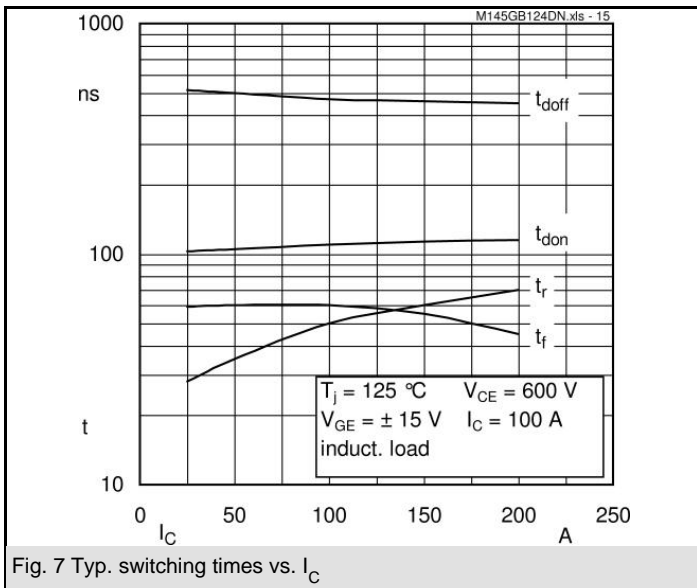

# SKM 145GB124DN

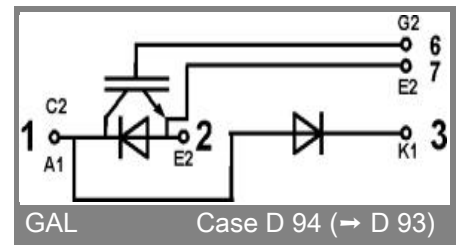
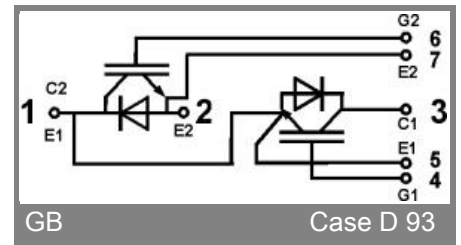
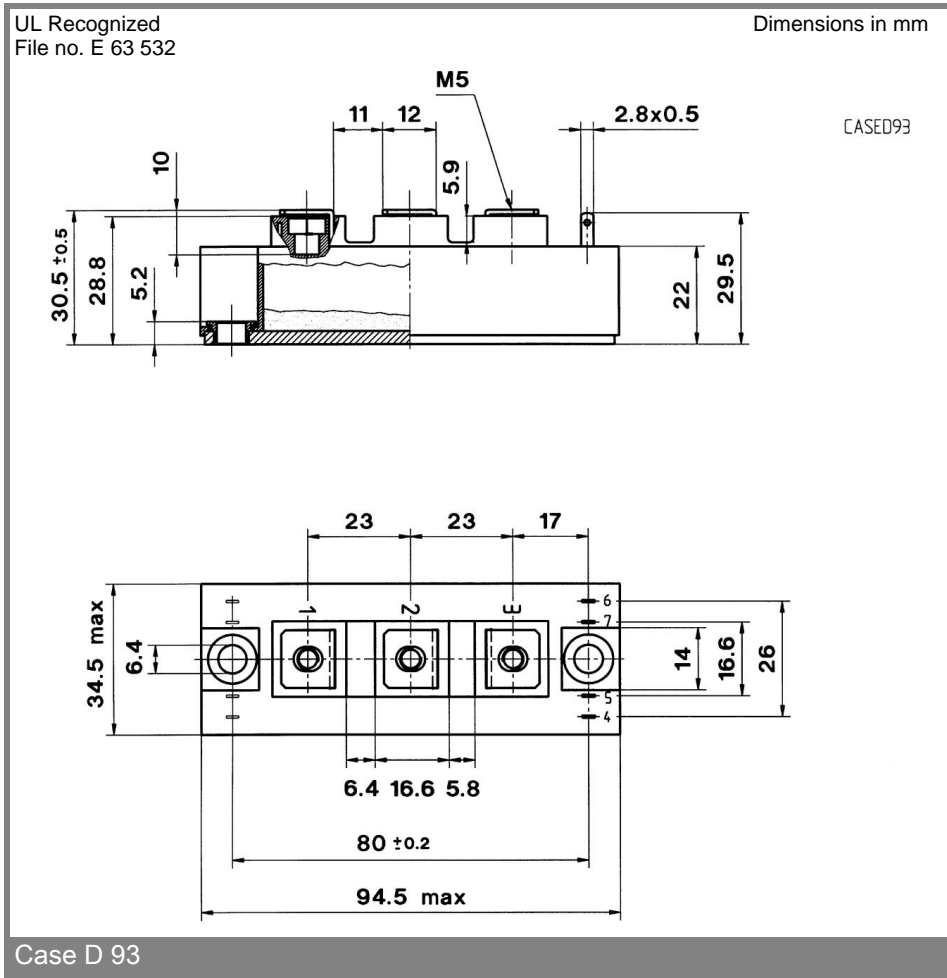
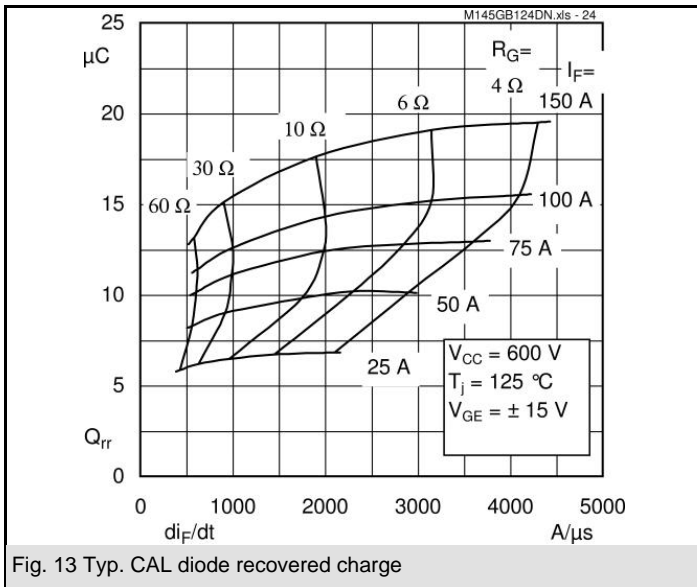

This is an electrostatic discharge sensitive device (ESDS), international standard IEC 60747-1, Chapter IX.

This technical information specifies semiconductor devices but promises no characteristics. No warranty or guarantee expressed or implied is made regarding delivery, performance or suitability.

Copyright © Each Manufacturing Company.

All Datasheets cannot be modified without permission.

This datasheet has been download from :

[www.AllDataSheet.com](http://www.AllDataSheet.com)

100% Free DataSheet Search Site.

Free Download.

No Register.

Fast Search System.

[www.AllDataSheet.com](http://www.AllDataSheet.com)