

SKT 24



Stud Thyristor

Line Thyristor

SKT 24

Features

- Hermetic metal case with glass insulator
- Threaded stud ISO M6 or UNF 1/4-28
- International standard case

Typical Applications

- DC motor control (e. g. for machine tools)
- Controlled rectifiers (e. g. for battery charging)
- AC controllers (e. g. for temperature control)
- Recommended snubber network e. g. for $V_{VRMS} \leq 400$ V:
 $R = 100 \Omega/5$ W, $C = 0,1 \mu F$

1) Available with UNF thread 1/4-28 UNF2A, e. g. SKT 24/12E UNF

V_{RSM} V	V_{RRM}, V_{DRM} V	$I_{TRMS} = 50$ A (maximum value for continuous operation) $I_{TAV} = 24$ A (sin. 180; $T_c = 95$ °C)	
500	400	SKT 24/04D	
900	800	SKT 24/08D	
1300	1200	SKT 24/12E ¹⁾	
1500	1400	SKT 24/14E	
1700	1600	SKT 24/16E ¹⁾	
1900	1800	SKT 24/18E	

Symbol	Conditions	Values	Units
I_{TAV}	sin. 180; $T_c = 100$ (85) °C;	22 (29)	A
I_D	K5; $T_a = 45$ °C; B2 / B6 K3; $T_a = 45$ °C; B2 / B6	22 / 30 28 / 40	A
I_{RMS}	K5; $T_a = 45$ °C; W1C	24	A
I_{TSM}	$T_{vj} = 25$ °C; 10 ms $T_{vj} = 130$ °C; 10 ms	450 380	A
i^2t	$T_{vj} = 25$ °C; 8,35 ... 10 ms $T_{vj} = 130$ °C; 8,35 ... 10 ms	1000 720	A ² s
V_T	$T_{vj} = 25$ °C; $I_T = 75$ A	max. 1,9	V
$V_{T(TO)}$	$T_{vj} = 130$ °C	max. 1	V
r_T	$T_{vj} = 130$ °C	max. 10	mΩ
I_{DD}, I_{RD}	$T_{vj} = 130$ °C; $V_{RD} = V_{RRM}, V_{DD} = V_{DRM}$	max. 8	mA
t_{gd}	$T_{vj} = 25$ °C; $I_G = 1$ A; $di_G/dt = 1$ A/μs	1	μs
t_{gr}	$V_D = 0,67 * V_{DRM}$	2	μs
$(di/dt)_{cr}$	$T_{vj} = 130$ °C	max. 50	A/μs
$(dv/dt)_{cr}$	$T_{vj} = 130$ °C; SKT ...D / SKT ...E	max. 500 / 1000	V/μs
t_q	$T_{vj} = 130$ °C,	80	μs
I_H	$T_{vj} = 25$ °C; typ. / max.	80 / 150	mA
I_L	$T_{vj} = 25$ °C; typ. / max.	150 / 300	mA
V_{GT}	$T_{vj} = 25$ °C; d.c.	min. 3	V
I_{GT}	$T_{vj} = 25$ °C; d.c.	min. 100	mA
V_{GD}	$T_{vj} = 130$ °C; d.c.	max. 0,25	V
I_{GD}	$T_{vj} = 130$ °C; d.c.	max. 3	mA
$R_{th(j-c)}$	cont.	0,8	K/W
$R_{th(j-c)}$	sin. 180	0,9	K/W
$R_{th(j-c)}$	rec. 120	0,95	K/W
$R_{th(c-s)}$		0,5	K/W
T_{vj}		- 40 ... + 130	°C
T_{stg}		- 40 ... + 150	°C
V_{isol}		-	V~
M_s	to heatsink	2,5	Nm
a		5 * 9,81	m/s ²
m	approx.	13	g
Case		B 2	



SKT

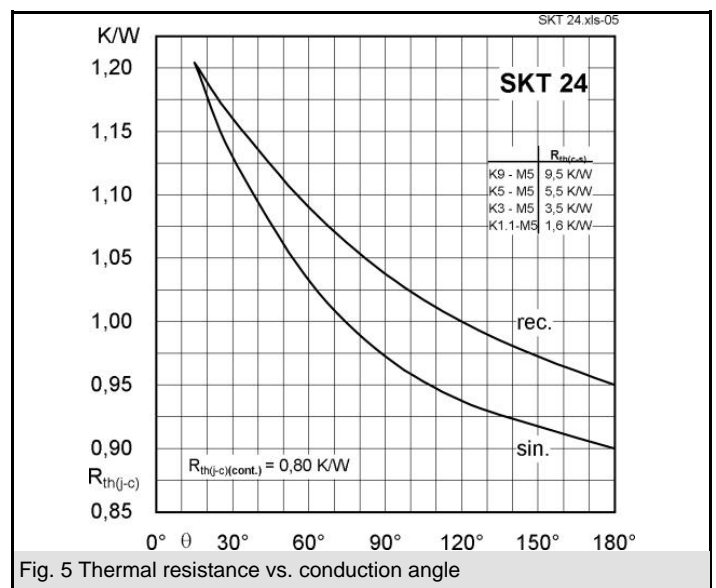
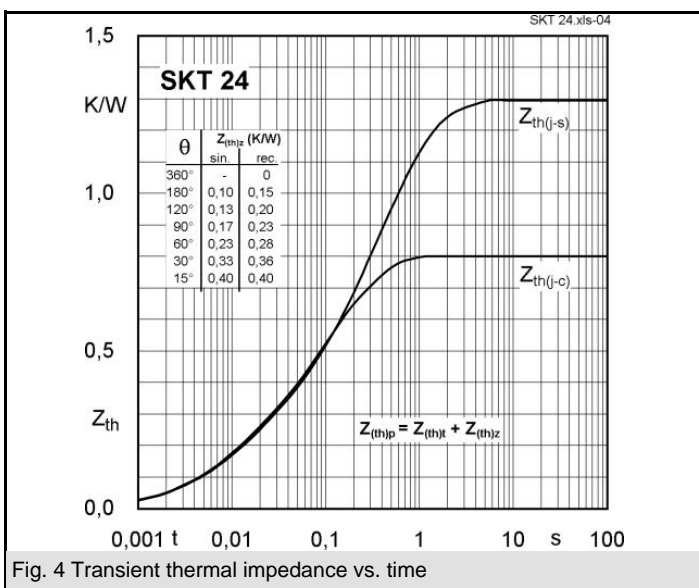
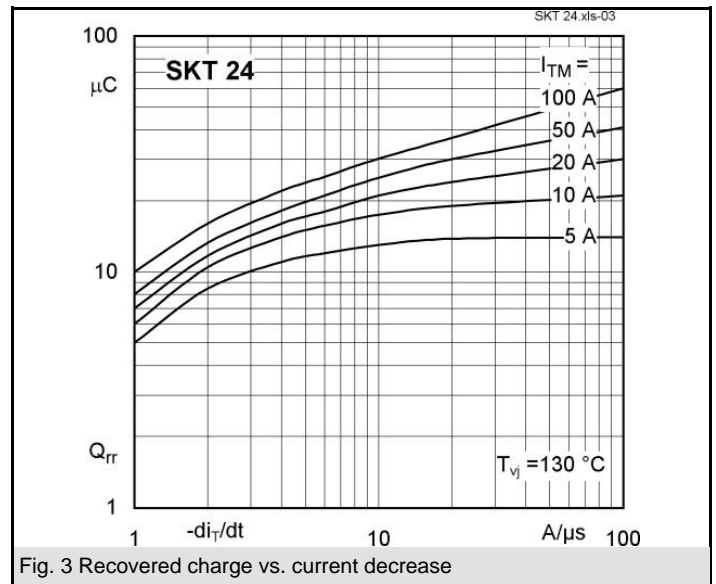
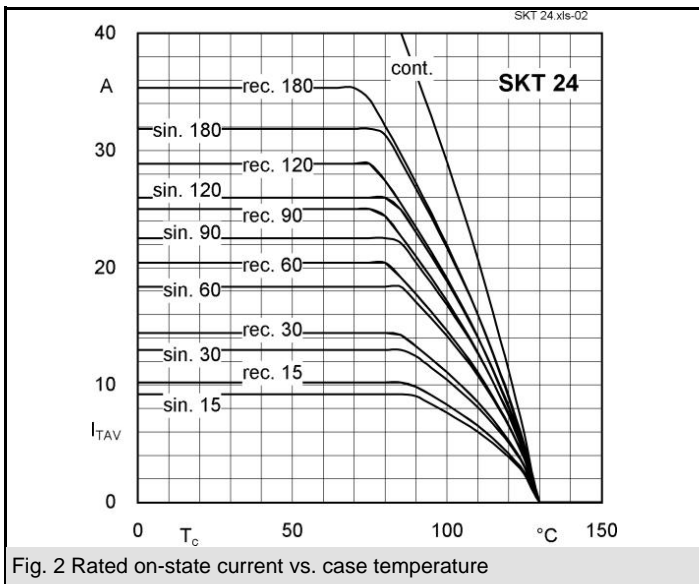
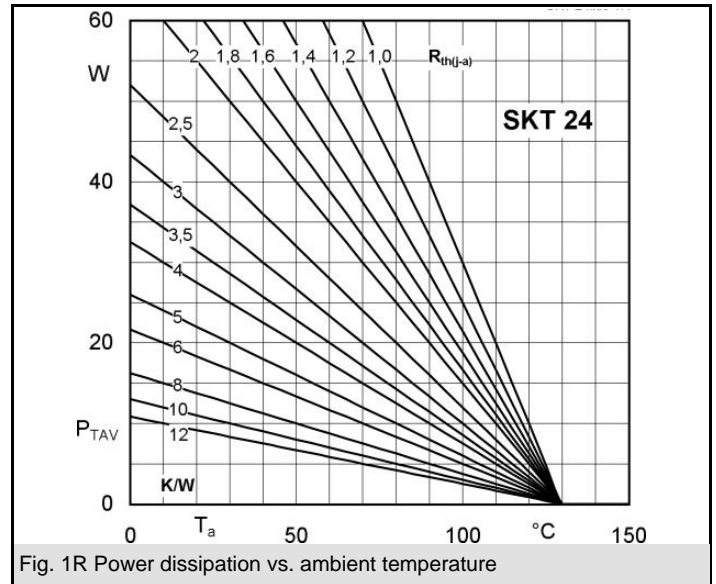
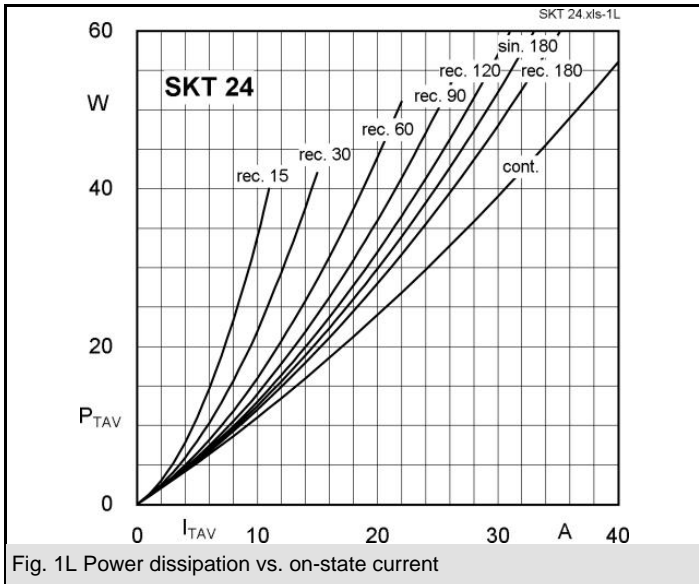

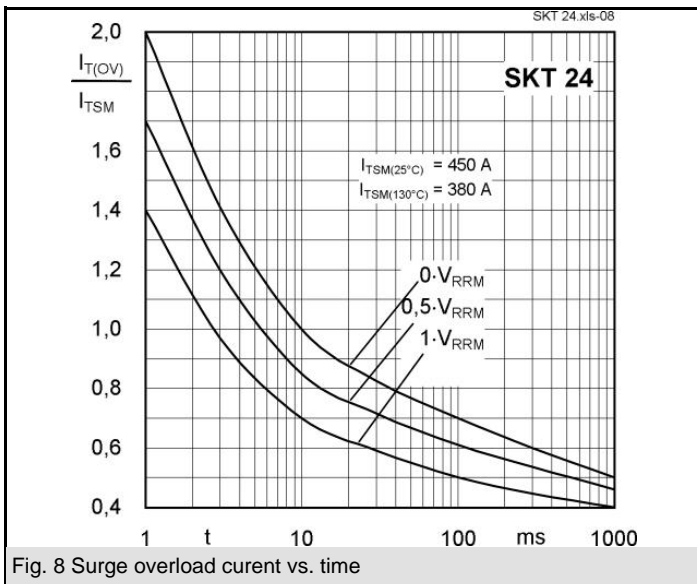
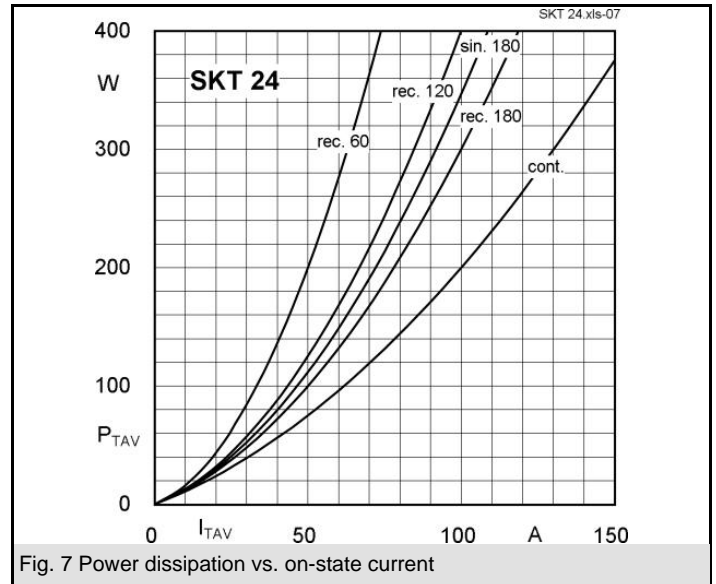
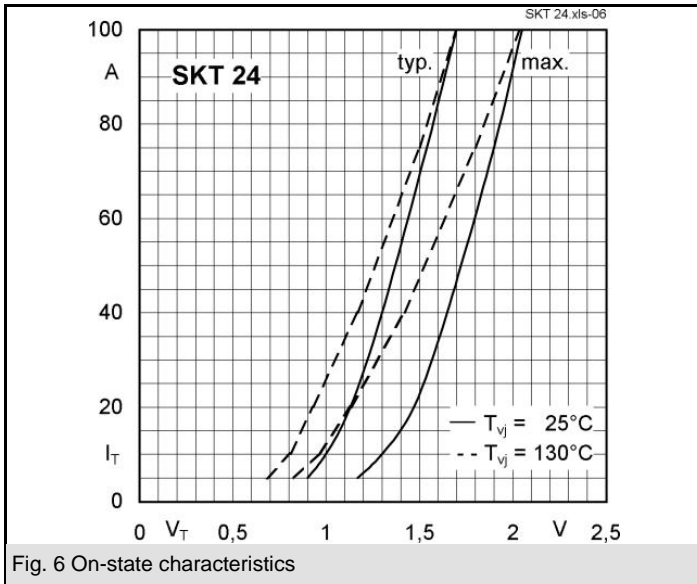

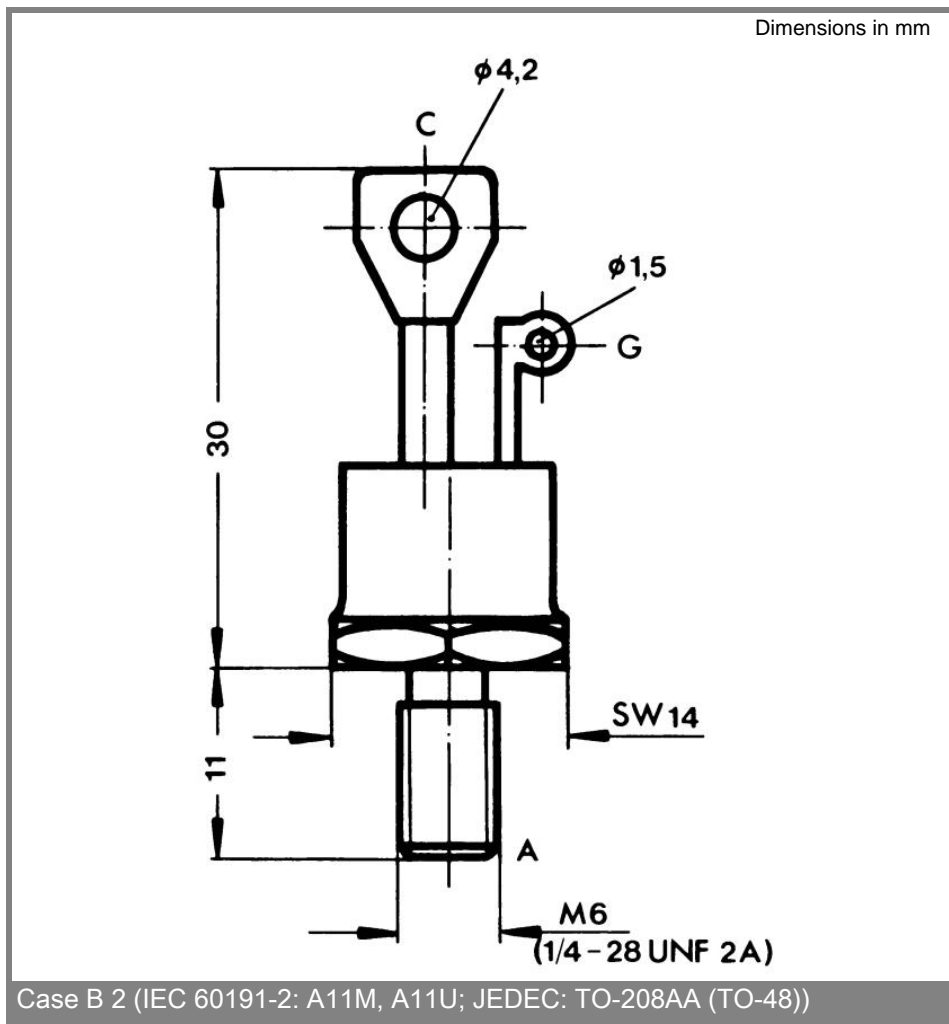
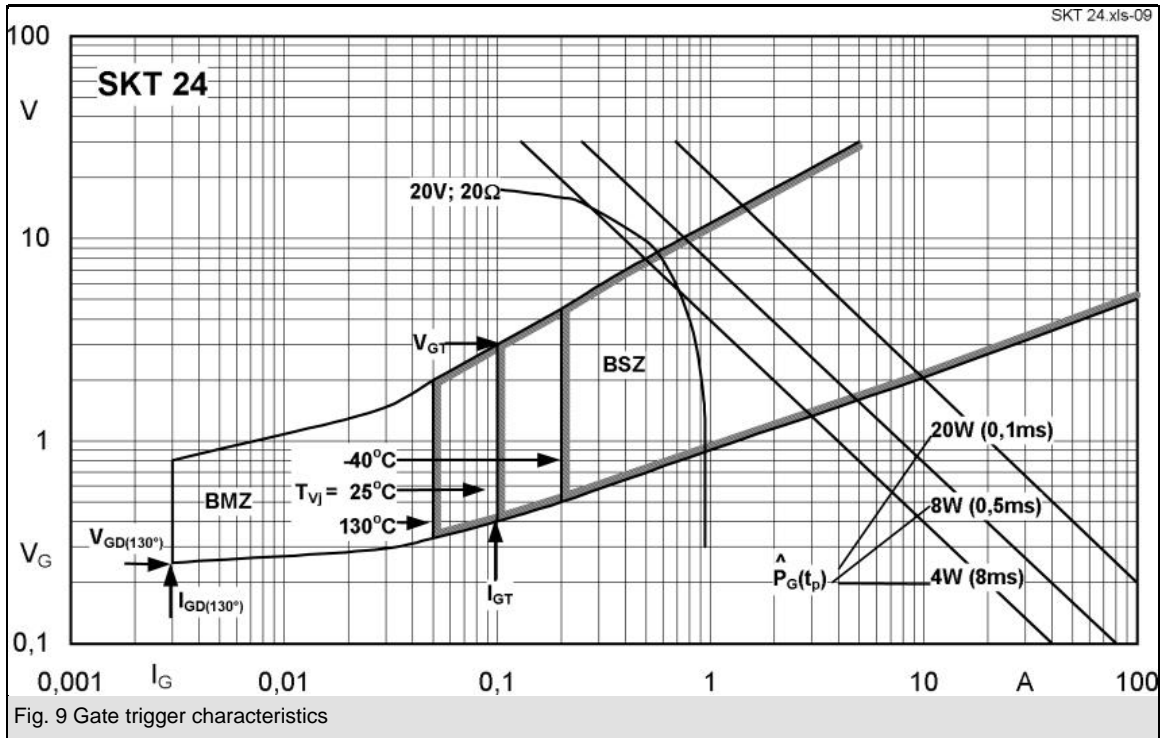

This technical information specifies semiconductor devices but promises no characteristics. No warranty or guarantee expressed or implied is made regarding delivery, performance or suitability.