



三合微科股份有限公司
SAMHOP Microelectronics Corp.

SM3501

FAN CONTROLLER

GENERAL DESCRIPTION

SM3501 is a Fan Controller CMOS IC, has three wind modes; normal, rhythm and sleep wind. Four kinds of timer setting and a toggled O/P that can be used as swing/light.

Memory function is available; the Speed, Mode, Swing functions will operate as last state; if last state is Sleep mode, press SPEED or ON/OFF key enable fan controller while memory functions(Speed / Mode / Swing) will be returned to the last state before sleep mode operation.

FEATURES

- * High performance CMOS technology
- * 455KHz or RC type can be selected.
- * Two to three wind modes can be selected.
Normal, Rhythm and Sleep wind mode.
- * Three-wind grade control in each wind mode:
Low, Medium and Strong wind.
- * Four types of timer setting by PIN option:
ladder adder (1/2 - 1 - 2 - 4 - 8HRS / 1 - 2 - 4HRS)
non-ladder adder (1 - 2 - 4 - 8HRS / 1 - 2 - 4HRS)
- * SPEED or ON/OFF key can enable fan controller by PIN option

APPLICATIONS

- * Electronic Fan
- * Heater Fan

PIN ASSIGNMENT

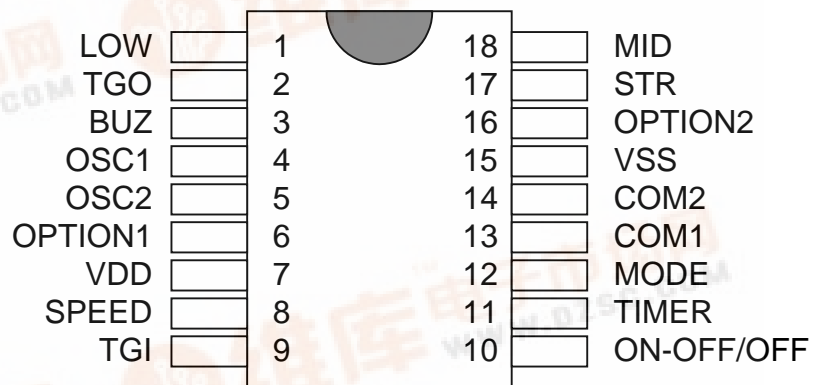

SM3501



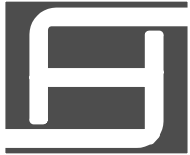

PIN FUNCTION

No.	Pin Name	I/O	Function
1	LOW	O	Wind speed control output
2	TGO	O	Toggle output
3	BUZ	O	Trigger output to drive piezo
4	OSC1	I	Crystal input
5	OSC2	O	Crystal output
6	OPTION1	I	Fan start-up option-float: Speed, VDD:ON/OFF
7	VDD	POWER	Positive power
8	SPEED	I/O	Wind grade selection input and LED output
9	TGI	I/O	Toggle output control input and LED output
10	OFF/ON-OFF	I/O	ON-OFF or OFF function control input and LED output
11	TIMER	I/O	Timer setting input and LED output
12	MODE	I/O	Wind mode selection input and LED output
13	COM1	O	LED scanning common pin
14	COM2	O	LED scanning common pin
15	VSS	POWER	Negative power supply
16	OPTION2	I	Timer mode option-float: nonadder, VSS: adder
17	STR	O	Wind speed control output
18	MID	O	Wind speed control output



PANEL DISPLAY



* NOTE: " ● " Function can be chosen.

BLOCK DIAGRAM

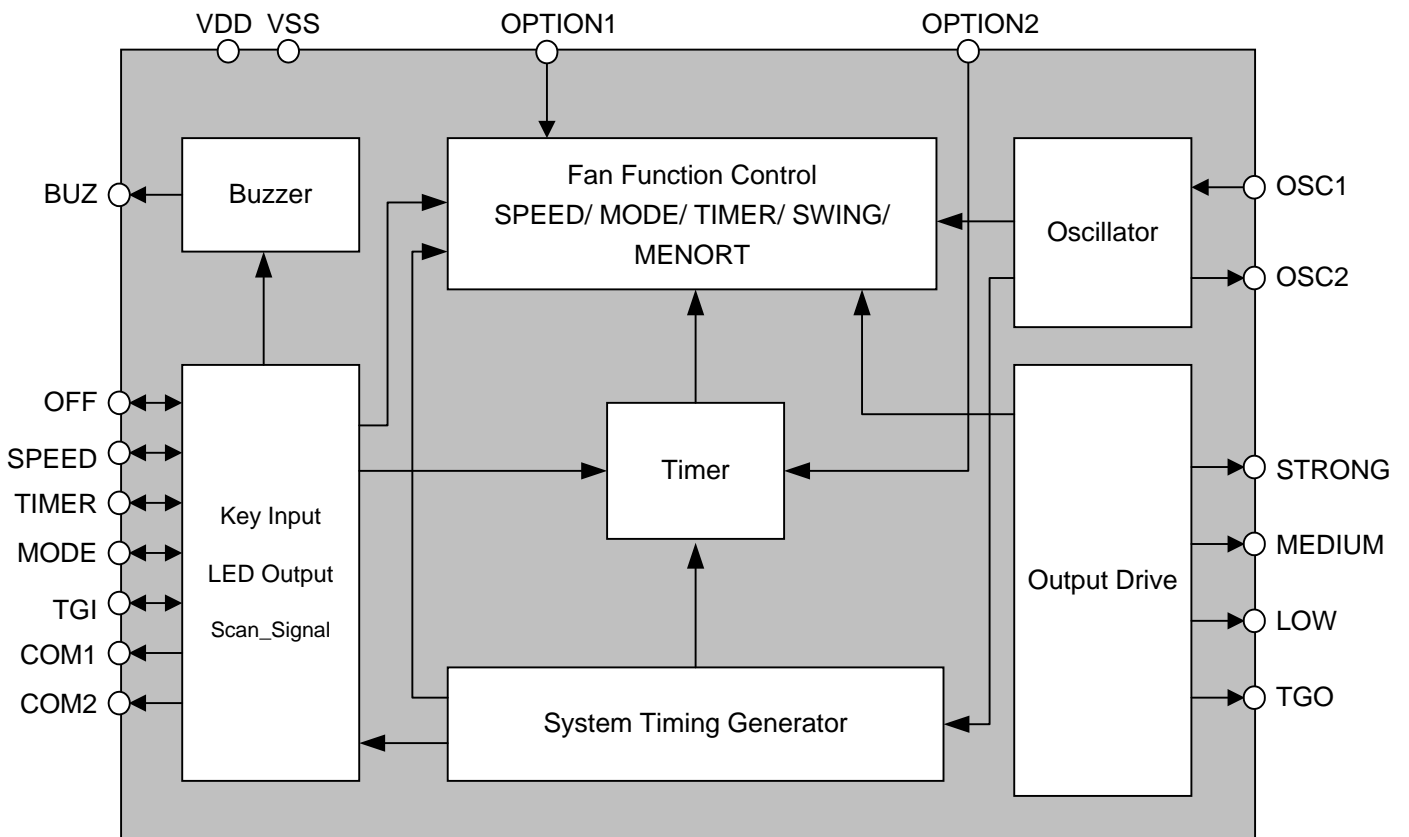

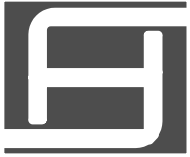

FUNCTION DESCRIPTION

SM3501 has five control signal operations:

* Start-up by SPEED key

- a. function turn off (OFF key)
- b. wind mode select (MODE key)
- c. start-up function and wind speed select (ON / SPEED key)
- d. timer setting (TIMER key)
- e. swing head or light (TGI key)

* Start-up by ON / OFF key

- a. function control (ON / OFF key)
- b. wind mode select (MODE key)
- c. wind speed select (SPEED key)
- d. timer setting (TIMER key)
- e. swing head or light (TGI key)

Only SPEED or ON / OFF key can enable the fan controller ; wind mode, timer and swing head inputs can not be accepted when fan is not activated. The fan controller will be turned off by timer time out or OFF (ON / OFF) key inputs.

When more than one key are pressed, controller will not accept the multi-key's control signal, if the panel keys are pressed more than six seconds, controller will generate a "Bi-Bi-Bi-Bi" warning sound.

state of fan controller is as

follows:

* Memory function available

If Fan controller is OFF on sleep mode, all memory functions will be returned to the LAST STATE BEFORE SLEEP MODE operation.

- a. grade as last state but with starting medium wind for three seconds
- b. the wind mode as last state except sleep mode
- c. swing function as last state
- d. timer setting off

A. OFF KEY

When fan controller is on, press the OFF key on panel, fan functions will be turned off.

* PIN 6 OPTION1: **ON / OFF KEY**

When fan controller functions are on, press ON / OFF key on panel, fan function will be turned off; if functions are off, press the key to turn on fan functions.

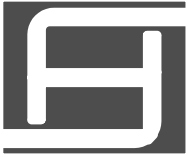

B. SPEED KEY

When fan controller is off, press SPEED key on panel, fan is turned on, initial state is LOW wind; when memory function is available, the wind grade will operate as last state. Both conditions there are three seconds starting wind. Press the SPEED key again, the wind will be changed as follows:

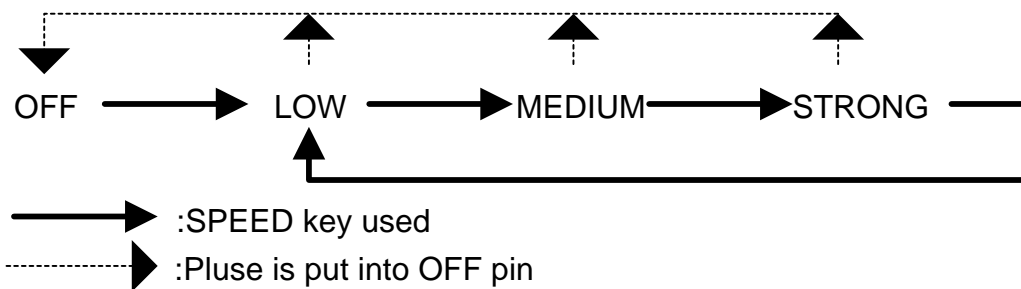

* PIN 6 OPTION1: SPEED KEY ONLY

If fan controller is off, SPEED key cannot be used, must press ON / OFF key to turn on the fan controller. When fan controller is on, press SPEED key on panel the wind grade changes as follows:

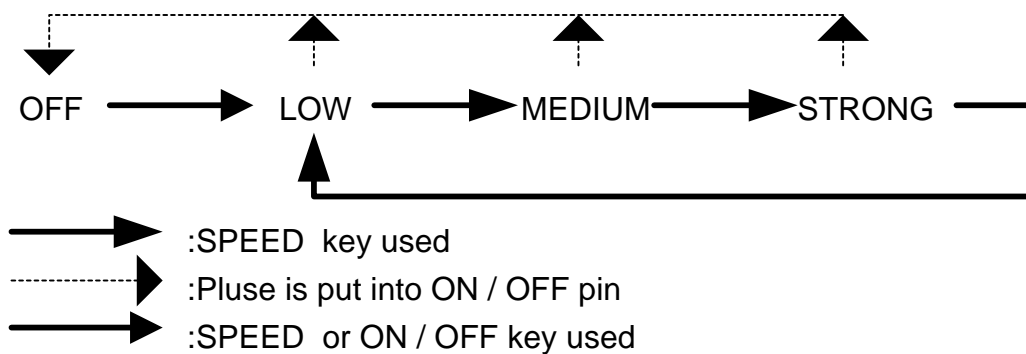

C. MODE KEY

SM3501 has three types of wind mode key setting. Memory function is available except on sleep mode.

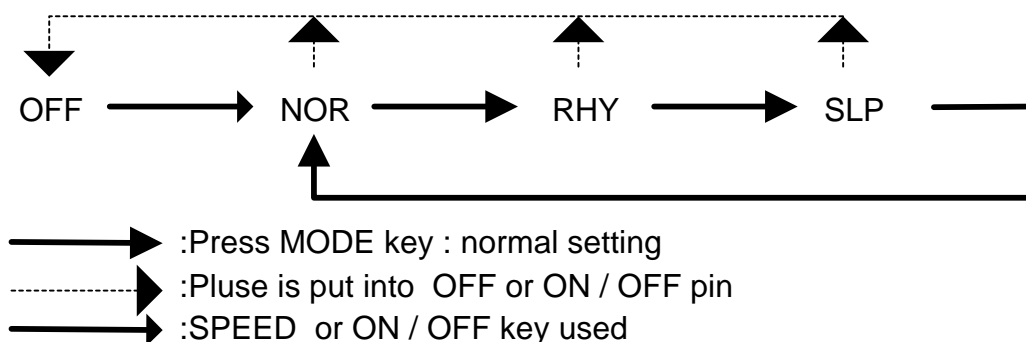

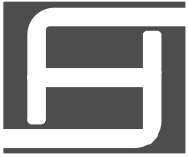

*** PIN 16 OPTION2:**

Two kinds of wind mode operation, these can be chosen by mode key setting.

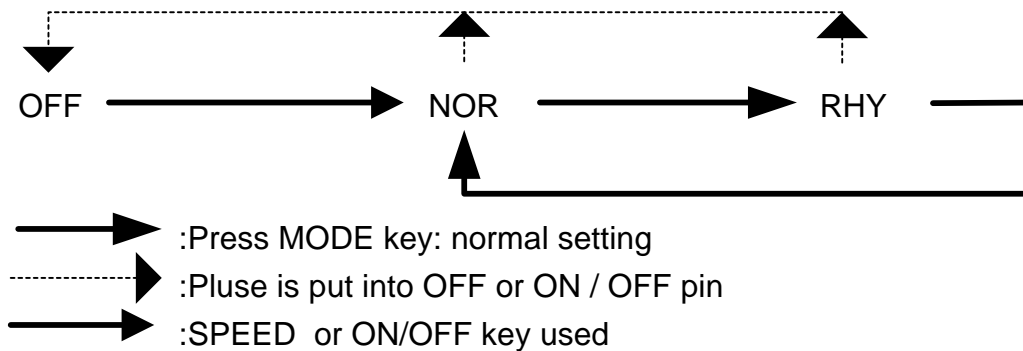

D. TGI KEY

The swing key will not activate when fan controller is off. Memory function is available, the swing output will operate as last state when press SPEED or ON / OFF key.



E. TIMER KEY SETTING

SM3501 has many types of timer setting, mode A is ladder-adder and mode B is non-ladder adder for three or four steps. Timer key will not activate when fan controller is off. These types of timer may be chosen by MASK or BONDING option.

F. BUZZER

Any key pressed on panel or fan controller receives a control signal form remote control handset, will generate a 4KHz 50% duty cycle pulse train on buzzer output pin.

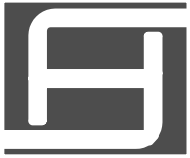

G. RHYTHM WIND FUNCTION

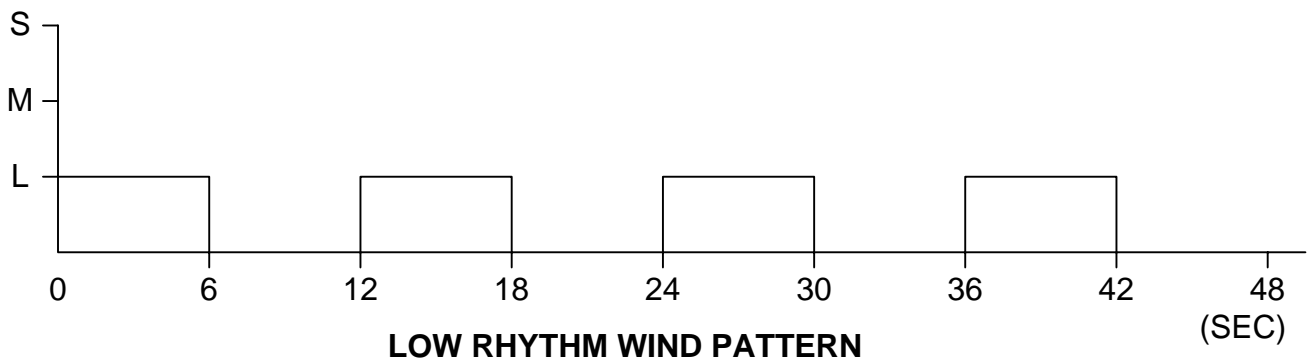
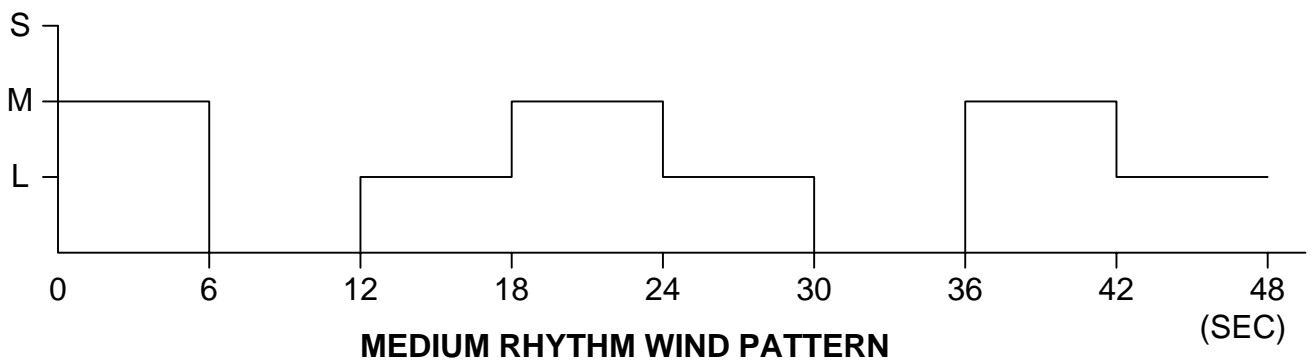
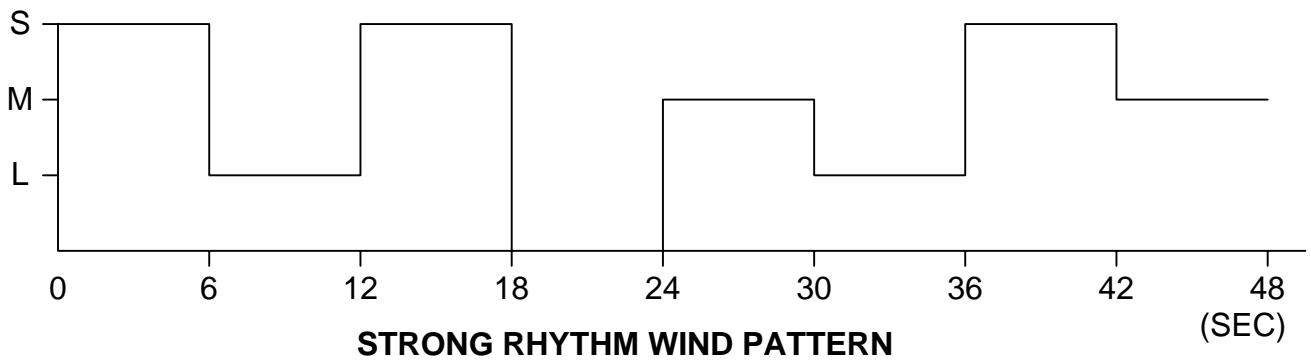



H. SLEEP WIND FUNCTION

In sleep mode, wind grade is changed by timing automatically.

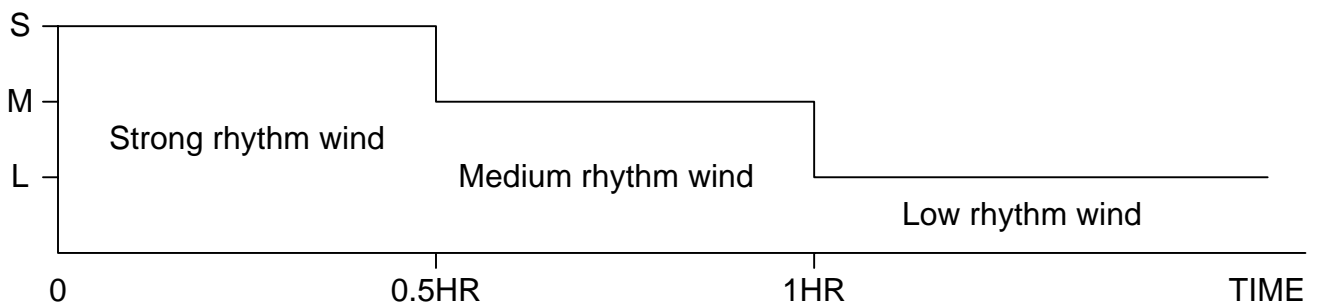

STRONG SLEEP WIND PATTERN

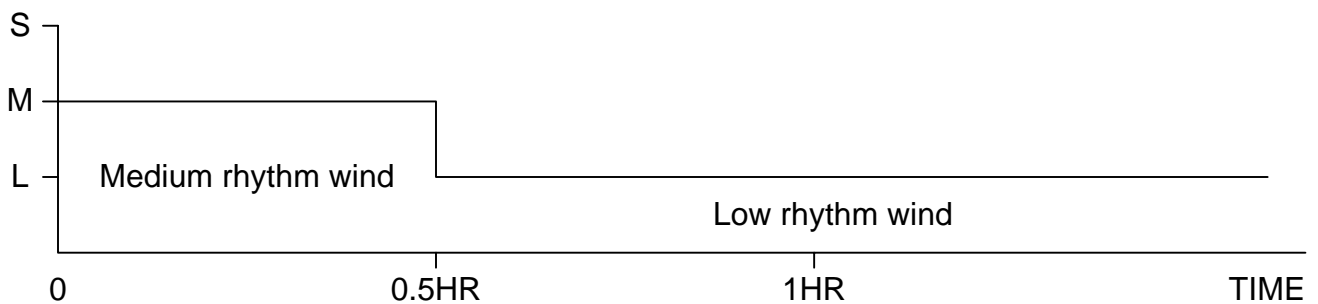

MEDIUM SLEEP WIND PATTERN

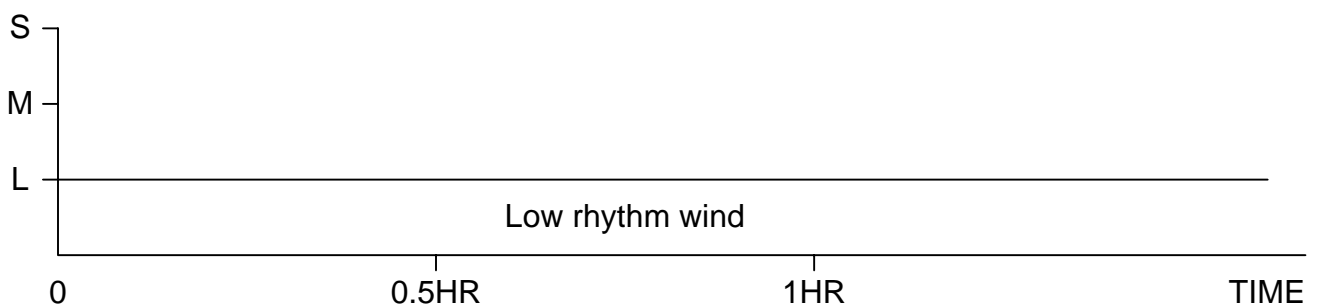

LOW SLEEP WIND PATTERN

* The wind grade goes down automatically one step every 0.5 hour, until low wind level is reached.



ABSOLUTE MAXIMUM RATINGS

Parameter	Symbol	Conditions	Ratings	Unit
Supply Voltage	VDD - Vss		-0.3 ~ 6	V
Input Voltage	VI - Vss		Vss -0.3 ~ VDD +0.3	V
Output voltage	VO - Vss		Vss -0.3 ~ VDD +0.3	V
Maximum power consumption	Pa	VDD - Vss = 5 V	500	mW
Operating temperaturer	Topr		-10 ~ 70	
Storage temperature	Tstg		-40 ~ 125	

DC ELECTRICAL CHARACTERISTICCS

Parameter	Symbol	Conditions	Limit			Unit
			Min.	Typ.	Max.	
Supply voltage	VDD - Vss		4	5	6	V
Stand-by current	ISB	OSC stop all output pins open all input fixed to VDD			500	μ A
Source current (OFF, MODE, SPEED, SWING, TIMER)	IOH	VOH=+4.3V		15		mA
Triac sink current (S, M, L, SWING)	IOL	VOL=+0.7V		25		mA
Sink current (COM1 ~ COM2)	IOL	VOL=+0.7V		60		mA
Sink current (BUZ)	IOL	VOL=+0.7V		10		mA

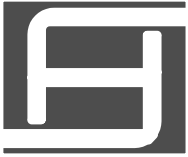

SM3501 PIN OPTION

	PIN 6	PIN 16
FLOATING	Start up by SPEED key	1-2-4 or 1-2-4-8HR, Non-accumulation
TO VDD	Start up by ON / OFF key	
TO VSS		1/2-1-2 or 1/2-1-2-4HR, Accumulation

SM3501 POWER SUPPLY APPLICATION CIRCUIT

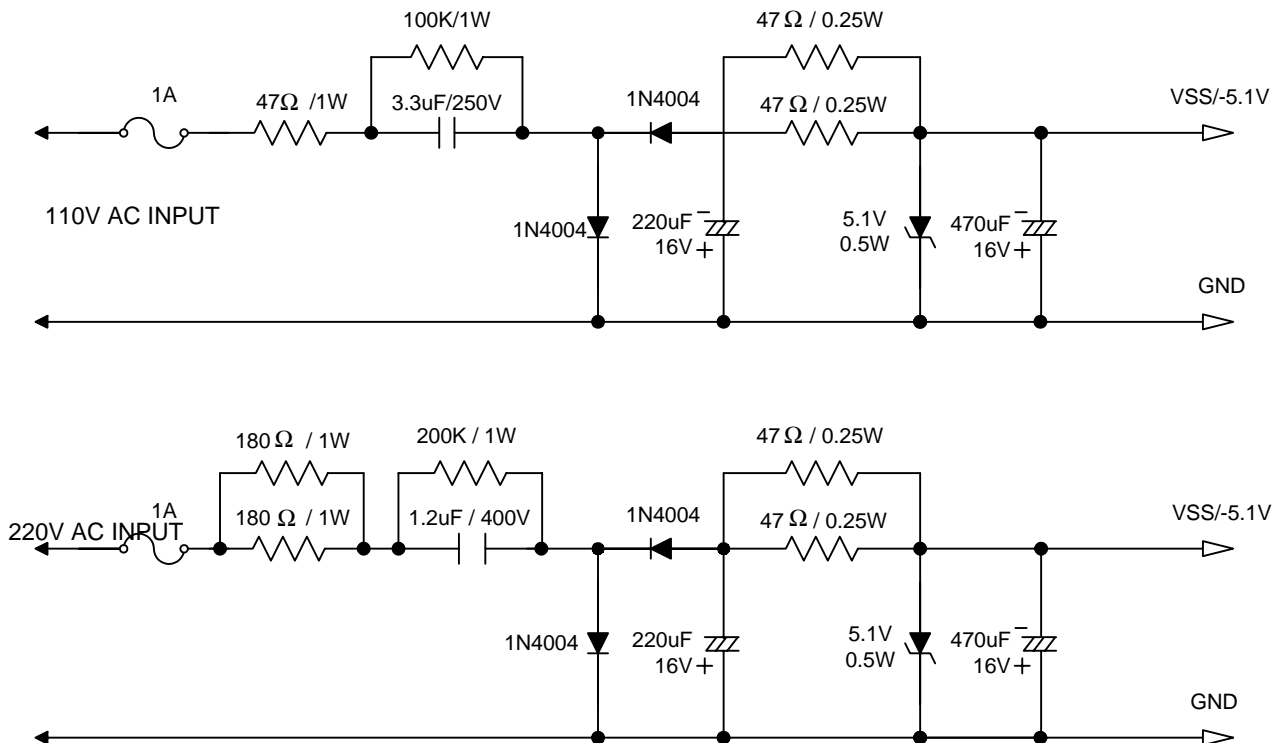

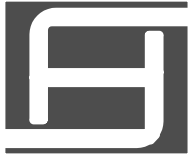

SM3501BX APPLICATION CIRCUIT

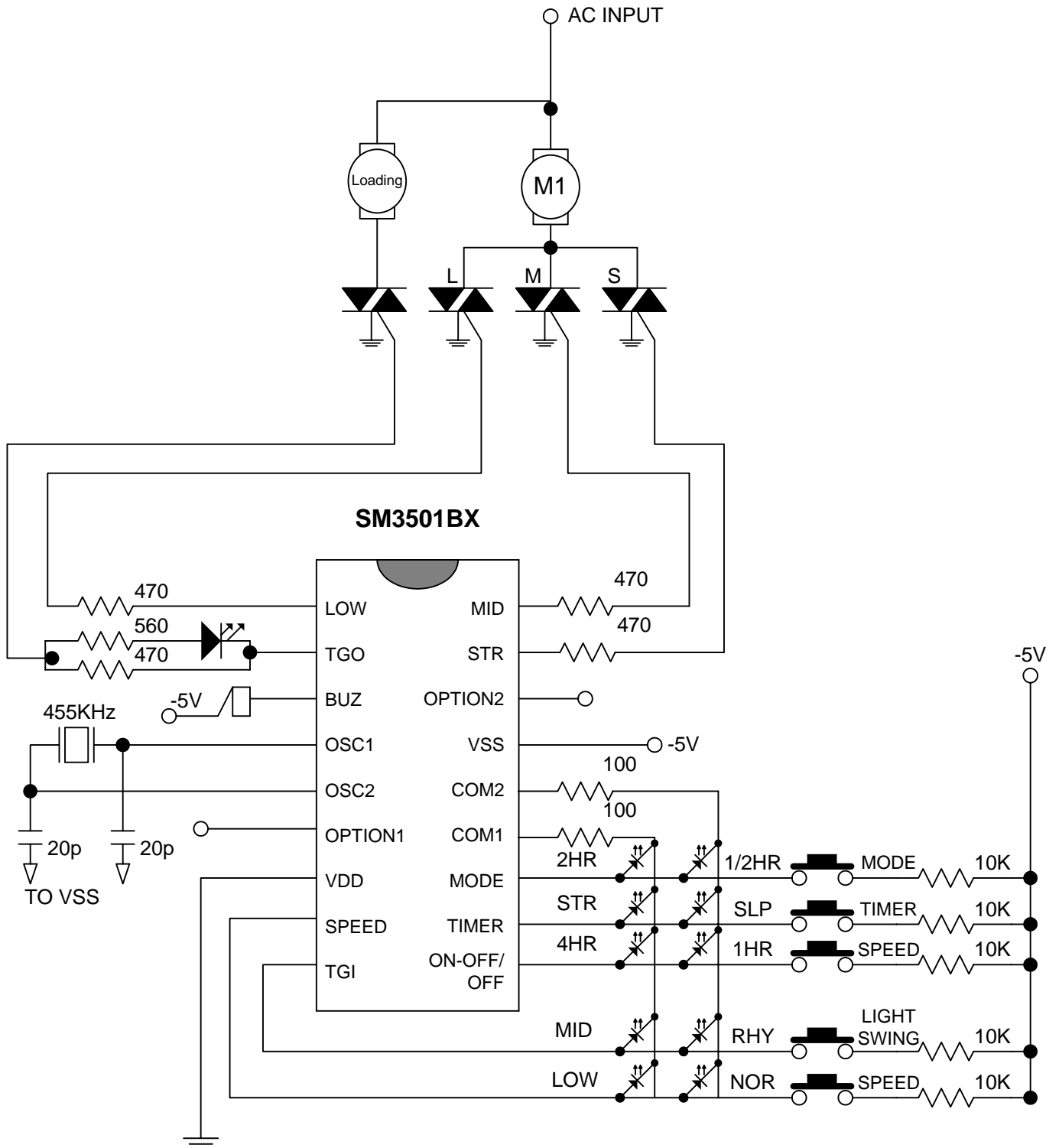



SM3501AX APPLICATION CIRCUIT

