



polyfet rf devices

SM705

General Description

Silicon VDMOS and LDMOS transistors designed specifically for broadband RF applications. Suitable for Military Radios, Cellular and Paging Amplifier Base Stations, Broadcast FM/AM, MRI, Laser Driver and others.

"Polyfet"TM process features low feedback and output capacitances resulting in high F_{\uparrow} transistors with high input impedance and high efficiency.

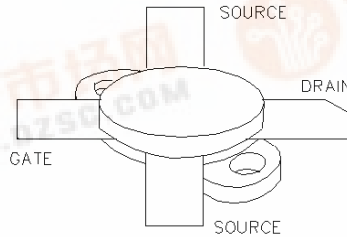

SILICON GATE ENHANCEMENT MODE

RF POWER VDMOS TRANSISTOR

150.0 Watts Single Ended

Package Style AM

**HIGH EFFICIENCY, LINEAR
HIGH GAIN, LOW NOISE**

ABSOLUTE MAXIMUM RATINGS (T = 25 °C)

Total Device Dissipation	Junction to Case Thermal Resistance	Maximum Junction Temperature	Storage Temperature	DC Drain Current	Drain to Gate Voltage	Drain to Source Voltage	Gate to Source Voltage
230 Watts	0.75 °C/W	200 °C	-65 °C to 150 °C	13.5 A	70V	70V	20 V

RF CHARACTERISTICS (150.0 WATTS OUTPUT)

SYMBOL	PARAMETER	MIN	TYP	MAX	UNITS	TEST CONDITIONS
Gps	Common Source Power Gain	13			dB	Idq = 0.80 A, Vds = 28.0 V, F = 150MHz
η	Drain Efficiency		70		%	Idq = 0.80 A, Vds = 28.0 V, F = 150MHz
VSWR	Load Mismatch Tolerance			20:1	Relative	Idq = 0.80 A, Vds = 28.0 V, F = 150MHz

ELECTRICAL CHARACTERISTICS (EACH SIDE)

SYMBOL	PARAMETER	MIN	TYP	MAX	UNITS	TEST CONDITIONS
Bvdss	Drain Breakdown Voltage	65			V	Ids = 100.00 mA, Vgs = 0V
Idss	Zero Bias Drain Current			5.0	mA	Vds = 28.0 V, Vgs = 0V
Igss	Gate Leakage Current			1	uA	Vds = 0V Vgs = 30V
Vgs	Gate Bias for Drain Current	1		7	V	Ids = 0.50 A, Vgs = Vds
gM	Forward Transconductance		6.0		Mho	Vds = 10V, Vgs = 5V
Rdson	Saturation Resistance		0.20		Ohm	Vgs = 20V, Ids \leq 2.50 A
Idsat	Saturation Current		35.00		Amp	Vgs = 20V, Vds = 10V
Ciss	Common Source Input Capacitance		250.0		pF	Vds = 28.0 Vgs = 0V, F = 1 MHz
Crss	Common Source Feedback Capacitance		15.0		pF	Vds = 28.0 Vgs = 0V, F = 1 MHz
Coss	Common Source Output Capacitance		160.0		pF	Vds = 28.0 Vgs = 0V, F = 1 MHz



SM705

POUT VS PIN GRAPH

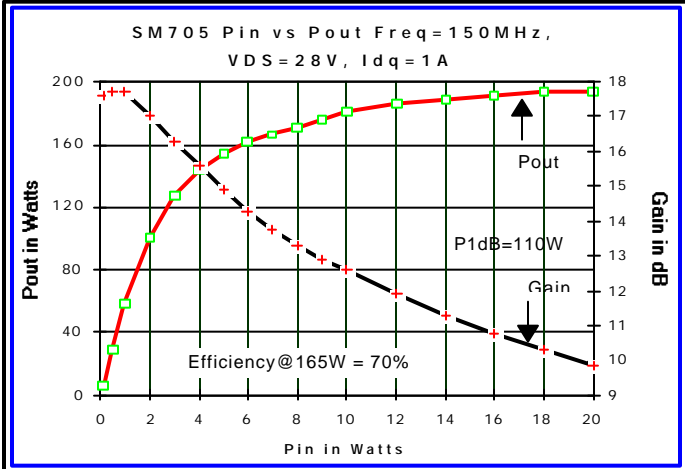

CAPACITANCE VS VOLTAGE

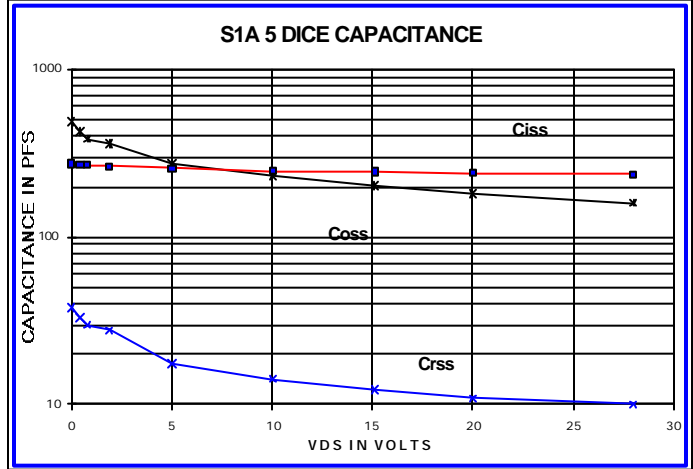

IV CURVE

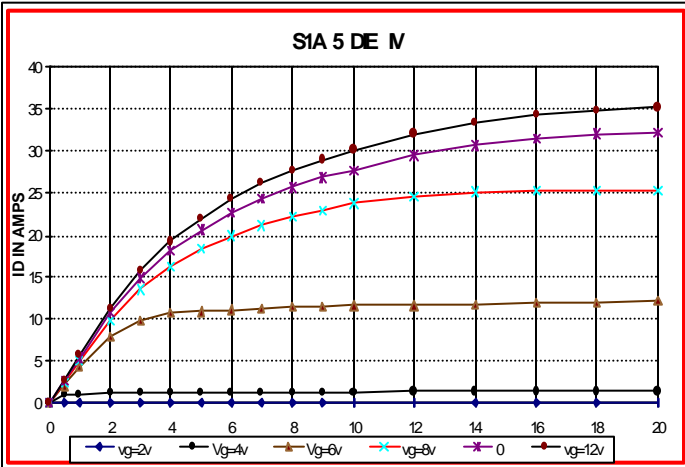

ID & GM VS VGS

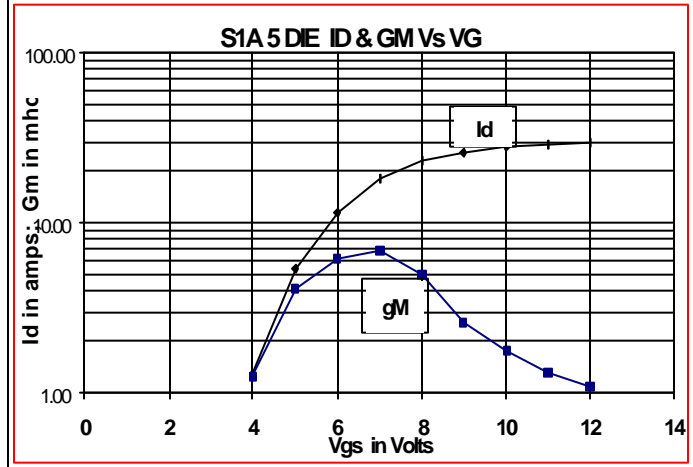

Zin Zout

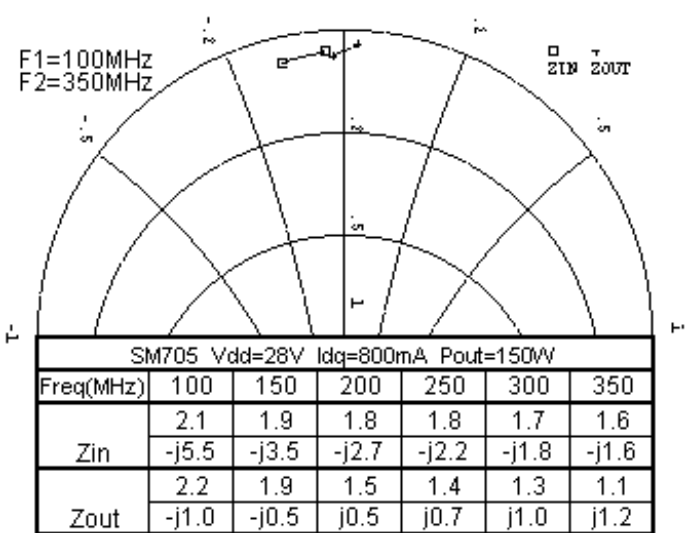

PACKAGE DIMENSIONS IN INCHES

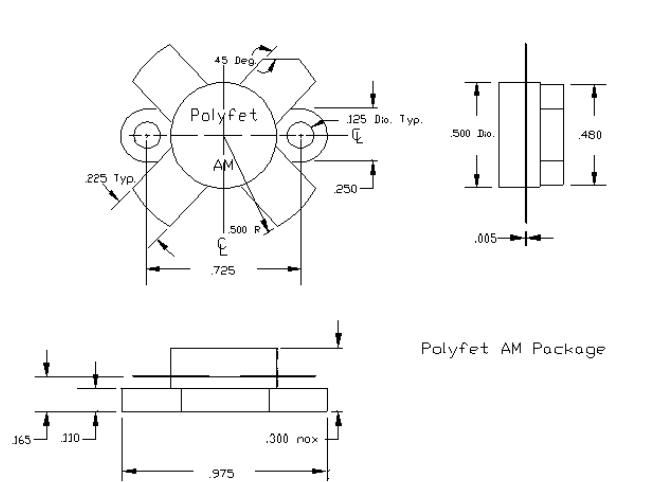

Tolerance .XX +/-0.01 .XXX +/- .005 inches