



SME1400B-17

Broadband Surface Mount Mixer

The Communications Edge™

Product Features

- RF 1 to 2200 MHz
- LO 1 to 2200 MHz
- IF 1 to 2000 MHz
- LO Drive: +17 dBm (Other Levels Available)
- No Internal Solder Connections

Product Photo



Specifications

Parameter	Units	Typical	Guaranteed	
			+25°C	-40° to +70°C
SSB Conversion Loss				
RF/LO = 10-1300 MHz, IF = 10-1000 MHz	dB	6.5	8.0	8.5
RF/LO = 10-2200 MHz, IF = 30-1000 MHz	dB	7.5	9.0	9.5
RF/LO = 1-2200 MHz, IF = 1-2000 MHz	dB	8.0		
Port-to-Port Isolation				
L-R = 10-1500 MHz	dB	30	20	21
L-R = 10-2200 MHz	dB	25	15	17
L-I = 10-2000 MHz	dB	26	19	20
L-I = 10-2200 MHz	dB	22	15	16
R-I	dB	25		
3rd Order Input Intercept Point	dBm	27		
VSWR				
R-Port = 600-2000 MHz		1.7:1		
R-Port = 10-2200 MHz		2.0:1		
L-Port = 600-2000 MHz		1.6:1		
L-Port = 10-2200 MHz		2.0:1		
I-Port		1.8:1		
1 dB Conversion Compression	dBm	+13		

1. Measured in a 50-ohm system with nominal LO drive of +17 dBm, low side LO, and downconverter application only, unless otherwise specified.

2. Measured at LO = 400-2100 MHz, RF = 500-2200 MHz, IF = 100 MHz, unless otherwise specified.

Absolute Maximum Ratings

Parameter	Rating
Operating Temperature	-40 to +70°C
Storage Temperature	-65 to +100°C
RF Input Power	+23 dBm at +25°C

Ordering Information

Part No.	Description
SME1400B-17	Mixer (Available in tape and reel)
SME1400B-17-PCB	Fully assembled application circuit

Performance Charts

IIP3 vs. Frequency

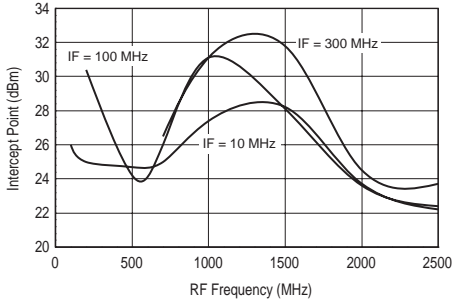

IIP3 vs. LO Power

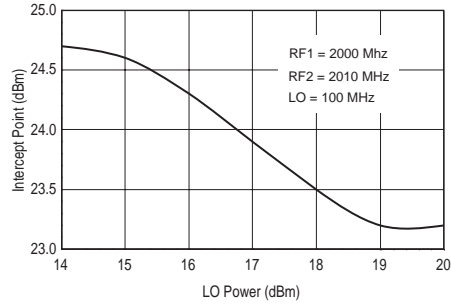

Conversion Loss vs. Frequency

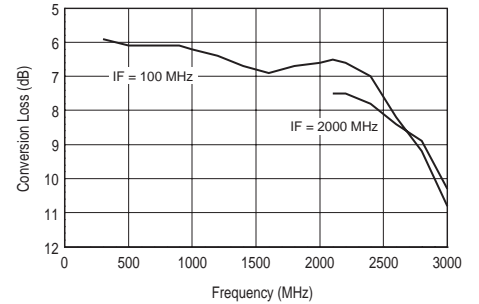

Conversion Loss vs. RF Power

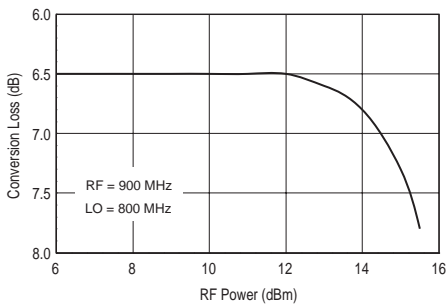

Conversion Loss vs. LO Power

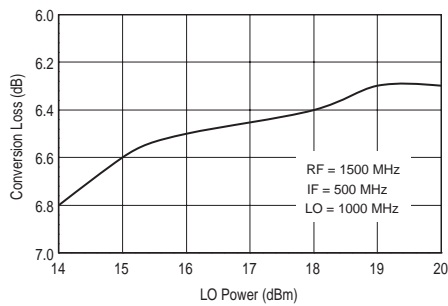

Conversion Loss vs. Temperature

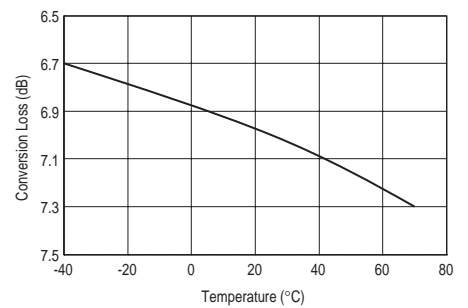

VSWR vs. Frequency

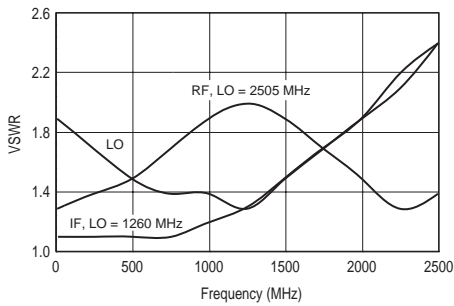

Isolation vs. Frequency

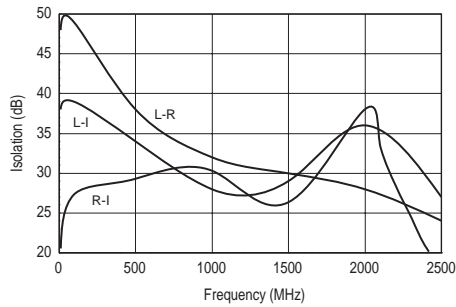

Single-Tone IM Products

Harmonics of RF	Harmonics of fLO					
	0	1	2	3	4	5
0		22	27	28	39	34
1	17	0	19	23	39	46
2	64	60	61	60	65	73
3	>80	77	>80	78	>80	>80
4	>80	>80	>80	>80	>80	>80
5	>80	>80	>80	>80	>80	>80

LO Mult	RF Mult	LO MHz	RF MHz	MHz	IM Prod dB
0	1	2150	2200	2200	17
0	2	2150	2200	4400	64
0	3	2150	2200	6600	81
0	4	2150	2200	8800	86
0	5	2150	2200	11000	86
1	0	2150	2200	2150	22
-1	1	2150	2200	50	0
-1	2	2150	1100	50	60
-1	3	2150	734	52	77
-1	4	2150	550	50	92
-1	5	2150	440	50	89
2	0	2150	2200	4300	27
-2	1	2150	4350	50	19
-2	2	2150	2175	50	61
-2	3	2150	1450	50	85
-2	4	2150	1088	52	90
-2	5	2150	870	50	88
3	0	2150	2200	6450	28
-3	1	2150	6500	50	23
-3	2	2150	3250	50	60
-3	3	2150	2167	51	78
-3	4	2150	1625	50	89
-3	5	2150	1300	50	88
4	0	2150	2200	8600	39
-4	1	2150	8650	50	39
-4	2	2150	4325	50	65
-4	3	2150	2884	52	81
-4	4	2150	2163	52	90
-4	5	2150	1730	50	87
5	0	2150	2200	10750	34
-5	1	2150	10800	50	46
-5	2	2150	5400	50	73
-5	3	2150	3600	50	88
-5	4	2150	2700	50	89
-5	5	2150	2160	50	89

Test Conditions RF at -10 dBm, LO at +17 dBm

RF harmonics and intermodulation products are referenced to a desired signal produced by fRF = 2200 MHz and fLO = 2150 MHz.

LO harmonics are referenced to the LO drive signal.

Outline Drawing

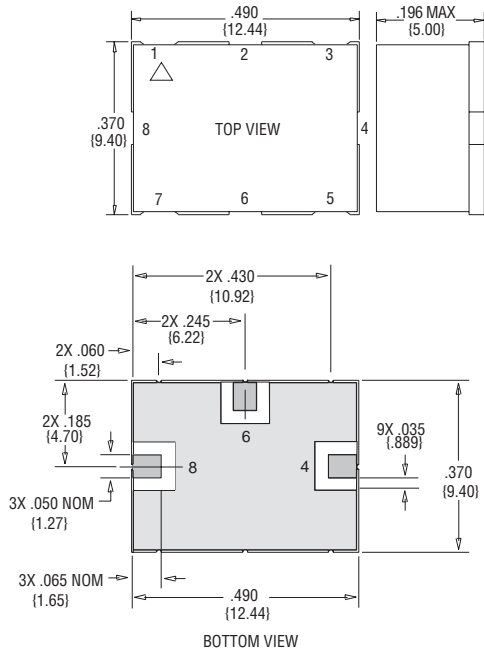

Function	Pin No.
RF	4
LO	8
IF	6
GND	1,2,3,5,7

Land Pattern

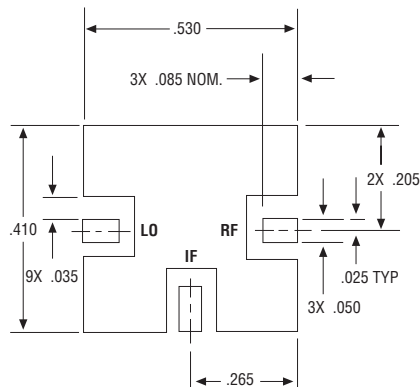

Specifications and information are subject to change without notice.



Caution! ESD sensitive device.

Copyright © Each Manufacturing Company.

All Datasheets cannot be modified without permission.

This datasheet has been download from :

www.AllDataSheet.com

100% Free DataSheet Search Site.

Free Download.

No Register.

Fast Search System.

www.AllDataSheet.com