

PROGRAMMABLE 27-BIT SERIAL-TO-PARALLEL RECEIVER

FEATURES

- **Serial Interface Technology**
- **Compatible with FlatLink™3G such as SN65LVDS301**
- **Supports Video Interfaces up to 24-bit RGB Data and 3 Control Bits Received over 1, 2 or 3 SubLVDS Differential Lines**
- **SubLVDS Differential Voltage Levels**
- **Up to 1.755 Gbps Data Throughput**
- **Three Operating Modes to Conserve Power**
 - Active mode QVGA - 17 mW
 - Typical Shutdown - 0.7 μ W
 - Typical Standby Mode - 27 μ W Typical
- **Bus-Swap Function for PCB-Layout Flexibility**
- **ESD Rating > 4 kV (HBM)**
- **Pixel Clock Range of 4 MHz–65 MHz**
- **Failsafe on all CMOS Inputs**
- **Packaged in 5 mm x 5 mm MicroStar Junior μ BGA® with 0,5 mm Ball Pitch**
- **Very low EMI meets SAE J1752/3 'Kh'-spec**

APPLICATIONS

- **Small Low-Emission Interface between Graphics Controller and LCD Display**
- **Mobile Phones & Smart Phones**
- **Portable Multimedia Players**

DESCRIPTION

The SN65LVDS302 receiver de-serializes FlatLink™3G compliant serial input data to 27 parallel data outputs. The SN65LVDS302 receiver contains one shift register to load 30 bits from 1, 2 or 3 serial inputs and latches the 24 pixel bits and 3 control bits out to the parallel CMOS outputs after checking the parity bit. If the parity check confirms correct parity, the Channel Parity Error (CPE) output remains low. If a parity error is detected, the CPE output generates a high pulse while the data output bus disregards the newly-received pixel. Instead, the last data word is held on the output bus for another clock cycle.

The serial data and clock are received via Sub Low-Voltage Differential Signalling (SubLVDS) lines. The SN65LVDS302 supports three operating power modes (Shutdown, Standby, and Active) to conserve power.

When receiving, the PLL locks to the incoming clock CLK and generates an internal high-speed clock at the line rate of the data lines. The data is serially loaded into a shift register using the internal high-speed clock. The deserialized data is presented on the parallel output bus with a recreation of the Pixel clock PCLK generated from the internal high-speed clock. If no input CLK signal is present, the output bus is held static with the PCLK and DE held low, while all other parallel outputs are pulled high.

The parallel (CMOS) output bus offers a bus-swap feature. The SWAP control pin controls the output pin order of the output pixel data to be either R[7:0], G[7:0], B[7:0], VS, HS, DE or B[0:7], G[0:7], R[0:7], VS, HS, DE. This gives a PCB designer the flexibility to better match the bus to the LCD driver pinout or to put the receiver device on the top side or the bottom side of the PCB. The F/S control input selects between a slow CMOS bus output rise time for best EMI and power consumption and a fast CMOS output for increased speed or higher load designs.

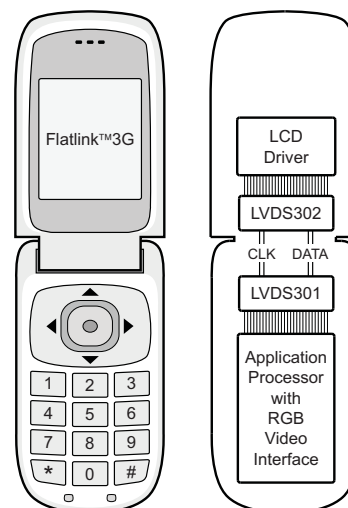

Please be aware that an important notice concerning availability, standard warranty, and use in critical applications of Texas Instruments semiconductor products and disclaimers thereto appears at the end of this data sheet.

FlatLink is a trademark of Texas Instruments.
 μ BGA is a registered trademark of Tessera, Inc.



These devices have limited built-in ESD protection. The leads should be shorted together or the device placed in conductive foam during storage or handling to prevent electrostatic damage to the MOS gates.

DESCRIPTION (CONTINUED)

Two Link Select lines LS0 and LS1 select whether 1, 2, or 3 serial links are used. The RXEN input may be used to put the SN65LVDS302 in a Shutdown mode. The SN65LVDS302 enters an active Standby mode if the common mode voltage of the CLK input becomes shifted to VDDLVS (e.g., transmitter releases the CLK output into high-impedance). This minimizes power consumption without the need of switching an external control pin. The SN65LVDS302 is characterized for operation over ambient air temperatures of -40°C to 85°C . All CMOS and SubLVDS signals are 2-V tolerant with $V_{DD}=0$ V. This feature allows signal powerup before V_{CC} is stabilized.

FUNCTIONAL BLOCK DIAGRAM

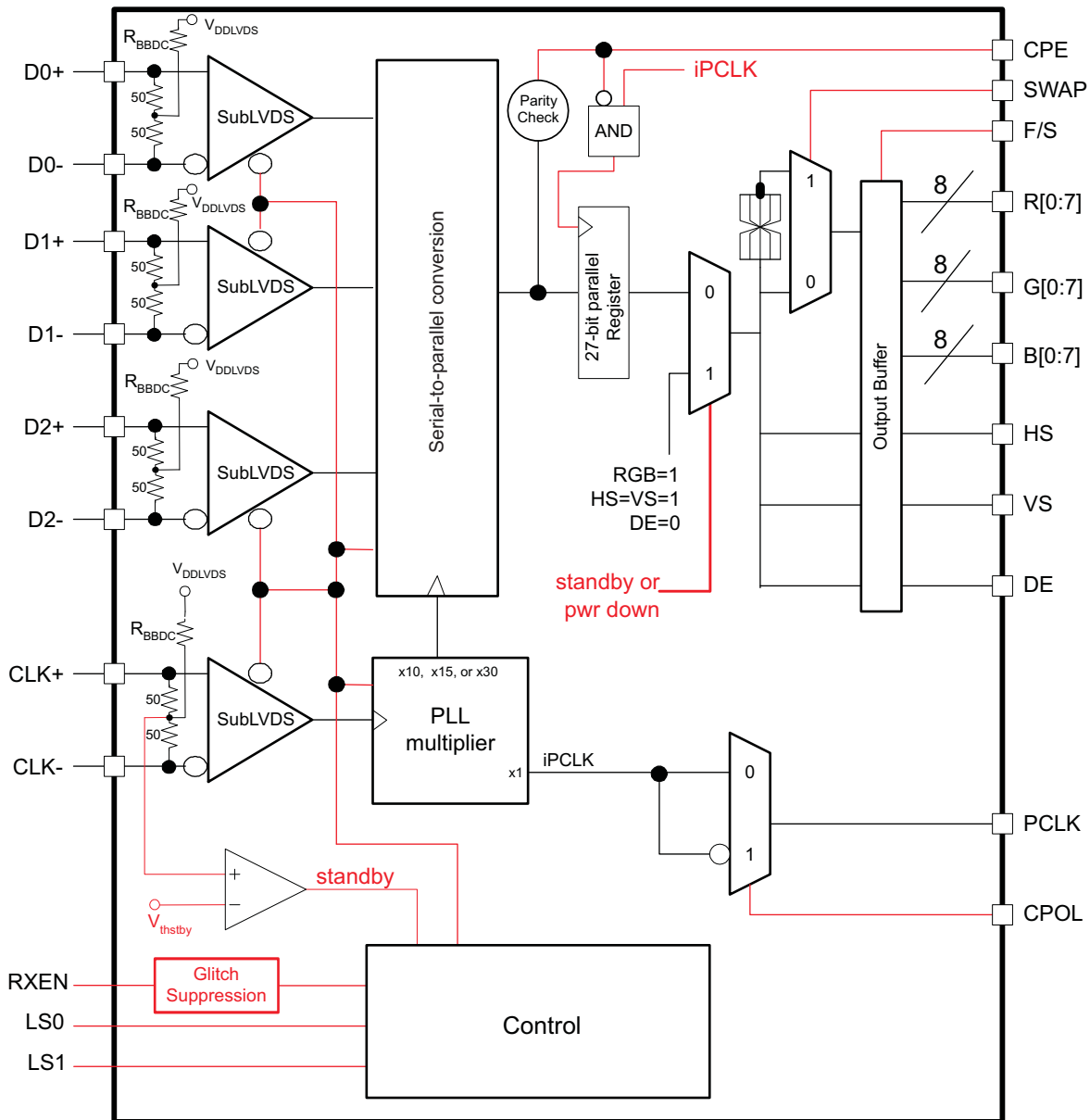

PINOUT – TOP VIEW

PINOUT - TOP VIEW

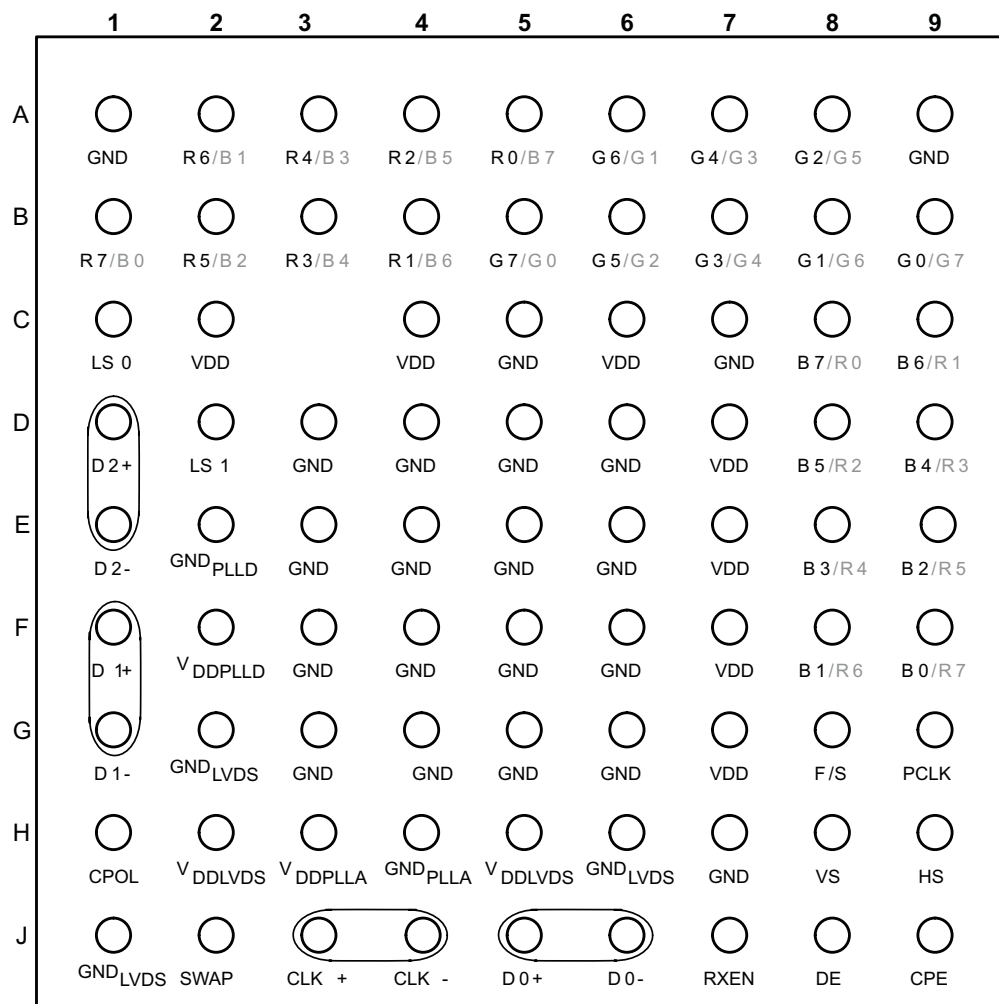

RGB Output pin assignment based on SWAP pin setting:
 SWAP = 0 / SWAP = 1

PINOUT – TOP VIEW (continued)

SWAP PIN FUNCTIONALITY

The SWAP pin allows the pcb designer to reverse the RGB bus, minimizing potential signal crossovers due to signal routing. The two drawings beneath show the RGB signal pin assignment based on the SWAP-pin setting.

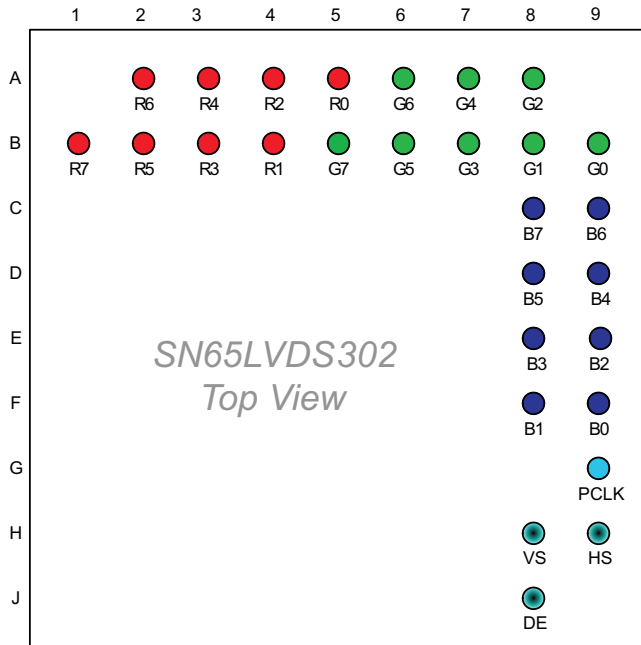

Figure 1. Pinout With SWAP PIN = GND

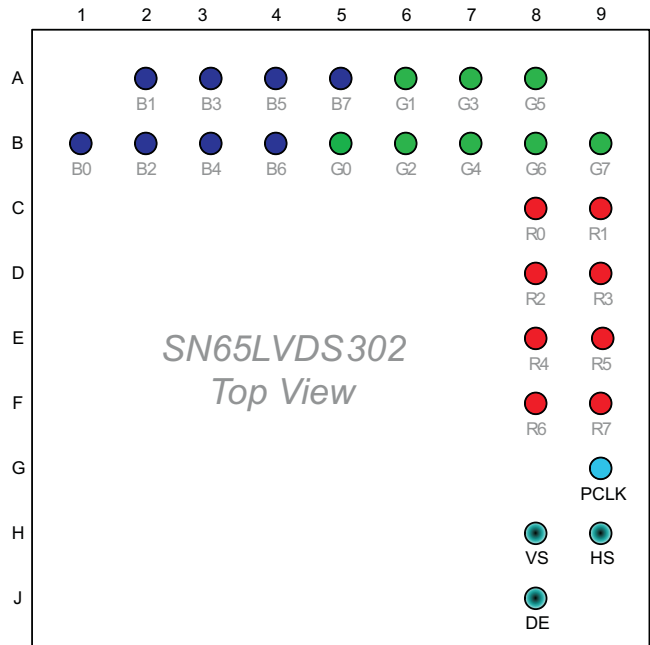

Figure 2. Pinout With SWAP PIN = VDD

PINOUT – TOP VIEW (continued)

Table 1. Pin Description

PIN	SWAP	SIGNAL	PIN	SWAP	SIGNAL	PIN	SWAP	SIGNAL
A1	–	GND	C1	–	LS0	F1	–	D1+
A2	L	R6	C2	–	V _{DD}	F2	–	V _{DDPLL} D
	H	B1	C3	unpopulated		F3	–	GND
A3	L	R4	C4	–	V _{DD}	F4	–	GND
	H	B3	C5	–	GND	F5	–	GND
A4	L	R2	C6	–	V _{DD}	F6	–	GND
	H	B5	C7	–	GND	F7	–	V _{DD}
A5	L	R0	C8	L	B7	F8	L	B1
	H	B7		H	R0		H	R6
A6	L	G6	C9	L	B6	F9	L	B0
	H	G1		H	R1		H	R7
A7	L	G4	D1	–	D2+	G1	–	D1–
	H	G3	D2	–	LS1	G2	–	GND _{LVDS}
A8	L	G2	D3	–	GND	G3	–	GND
	H	G5	D4	–	GND	G4	–	GND
A9	–	GND	D5	–	GND	G5	–	GND
B1	L	R7	D6	–	GND	G6	–	GND
	H	B0	D7	–	V _{DD}	G7	–	V _{DD}
B2	L	R5	D8	L	B5	G8	–	F/S
	H	B2		H	R2	G9	–	PCLK
B3	L	R3	D9	L	B4	H1	–	CPOL
	H	B4		H	R3	H2	–	V _{DDL} VDS
B4	L	R1	E1	–	D2–	H3	–	V _{DD} PLLA
	H	B6	E2	–	GND _{PLL} D	H4	–	GND _{PLLA}
B5	L	G7	E3	–	GND	H5	–	V _{DDL} VDS
	H	G0	E4	–	GND	H6	–	GND _{LVDS}
B6	L	G5	E5	–	GND	H7	–	GND
	H	G2	E6	–	GND	H8	–	VS
B7	L	G3	E7	–	V _{DD}	H9	–	HS
	H	G4	E8	L	B3	J1	–	GND _{LVDS}
B8	L	G1		H	R4	J2	–	SWAP
	B9	H	G6	E9	L	B2	J3	–
L		G0	H		R5	J4	–	CLK–
	H	G7				J5	–	D0+
						J6	–	D0–
						J7	–	RXEN
						J8	–	DE
						J9	–	CPE

TERMINAL FUNCTIONS

NAME	I/O	DESCRIPTION
D0+, D0–	SubLVDS in	SubLVDS Data Link (active during normal operation)
D1+, D1–		SubLVDS Data Link (active during normal operation when LS0 = high and LS1 = low, or LS0 = low and LS1=high; high impedance if LS0 = LS1 = low); input can be left open if unused
D2+, D2–		SubLVDS Data Link (active during normal operation when LS0 = low and LS1 = high, high-impedance when LS1 = low); input can be left open if unused
CLK+, CLK–		SubLVDS Input Pixel Clock; Polarity is fixed.
R0–R7	CMOS OUT	Red Pixel Data (8); pin assignment depends on SWAP pin setting
G0–G7		Green Pixel Data (8); pin assignment depends on SWAP pin setting
B0–B7		Blue Pixel Data (8); pin assignment depends on SWAP pin setting
HS		Horizontal Sync
VS		Vertical Sync
DE		Data Enable
PCLK		Output Pixel Clock; rising or falling clock polarity is selected by control input CPOL
LS0, LS1		Link Select (Determines active SubLVDS Data Links and PLL Range) See Table 2
RXEN	CMOS In	Disables the CMOS Drivers and Turns Off the PLL, putting device in shutdown mode 1 – Receiver enabled 0 – Receiver disabled (Shutdown) Note: RXEN input incorporates glitch suppression logic to avoid unwanted switching. The input must be pulled low for longer than 10µs continuously to force the receiver to enter Shutdown. The input must be pulled high for at least 10µs continuously to activate the receiver. An input pulse shorter than 5µs will be interpreted as glitch and becomes ignored. At power up, the receiver is enabled immediately if RXEN=H and disabled if RXEN=L
CPOL		Output Clock Polarity Selection 0 – rising edge clocking 1 – falling edge clocking
SWAP		Bus Swap swaps the bus pins to allow device placement on top or bottom of PCB. See pinout drawing for pin assignments. 0 – data output from R7...B0 1 – data output from B0...R7
F/S		CMOS bus rise time select 1 – fast output rise time 0 – slow output rise time
CPE	CMOS Out	Channel Parity Error This output indicates the detection of a parity error by generating an output high-pulse for half of a PCLK clock cycle; this allows counting parity errors with a simple counter. 0 – no error high-pulse – bit error detected
V _{DD}	Power Supply	Supply Voltage
GND		Supply Ground
V _{DDL} V _D S		SubLVDS I/O supply Voltage
GND _{LV} D _S		SubLVDS Ground
V _{DD} PLL _A		PLL analog supply Voltage
GND _{PLL} _A		PLL analog GND
V _{DD} PLL _D		PLL digital supply Voltage
GND _{PLL} _D		PLL digital GND

FUNCTIONAL DESCRIPTION

Deserialization Modes

The SN65LVDS302 receiver has three modes of operation controlled by link-select pins LS0 and LS1. Table 2 shows the deserializer modes of operation.

Table 2. Logic Table: Link Select Operating Modes

LS1	LS0	Mode of Operation		Data Links Status
0	0	1ChM	1-channel mode (30-bit serialization rate)	D0 active; D1, D2 disabled
0	1	2ChM	2-channel mode (15-bit serialization rate)	D0, D1 active; D2 disabled
1	0	3ChM	3-channel mode (10-bit serialization rate)	D0, D1, D2 active
1	1		Reserved	Reserved

1-Channel Mode

While LS0 and LS1 are held low, the SN65LVDS302 receives payload data over a single SubLVDS data pair, D0. The PLL locks to the SubLVDS clock input and internally multiplies the clock by a factor of 30. The internal high speed clock is used to shift in the data payload on D0 and to deserialize 30 bits of data. Figure 3 illustrates the timing and the mapping of the data payload into the 30-bit frame. The internal high speed clock is divided by a factor of 30 to recreate the pixel clock and the data payload with the pixel clock is presented on the output bus. The reserved bits and parity bit are not output. While in this mode, the PLL can lock to a clock that is in the range of 4 MHz through 15 MHz. This mode is intended for smaller video display formats that do not need the full bandwidth capabilities of the SN65LVDS302.



Figure 3. Data and Clock Input in 1-ChM (LS0 and LS1 = low)

2-Channel Mode

While LS0 is held high and LS1 is held low, the SN65LVDS302 receives payload data over two SubLVDS data pairs, D0 and D1. The PLL locks to the SubLVDS clock input and internally multiplies the clock by a factor of 15. The internal high speed clock is used to shift in the data payload on D0 and D1 and to deserialize 15 bits of data from each pair. Figure 4 illustrates the timing and the mapping of the data payload into the 30-bit frame. The internal high speed clock is divided by a factor of 15 to recreate the pixel clock, and the data payload with pixel clock is presented on the output bus. The reserved bits and parity bit are not output. While in this mode the PLL can lock to a clock that is in the range of 8 MHz through 30 MHz.

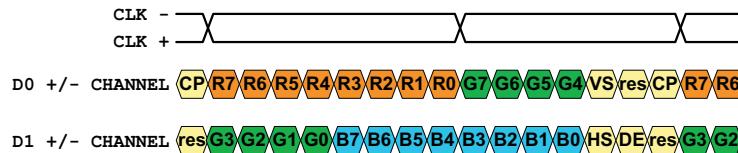

Figure 4. Data and Clock Input in 2-ChM (LS0 = high; LS1 = low)

3-Channel Mode

While LS0 is held low and LS1 is held high the SN65LVDS302 receives payload data over three SubLVDS data pairs: D0, D1, and D2. The PLL locks to the SubLVDS clock input and internally multiplies the clock by a factor of 10. The internal high speed clock is used to shift in the data payload on D0, D1, and D2, and to deserialize 10 bits of data from each pair. Figure 5 illustrates the timing and the mapping of the data payload into the 30-bit frame. While in this mode the PLL can lock to a clock that is in the range of 20 MHz through 65 MHz.

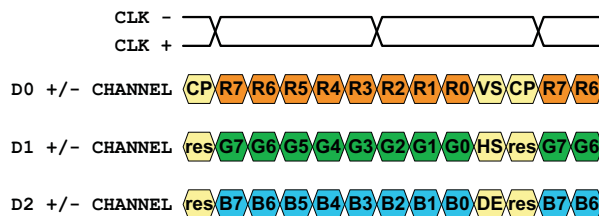

Figure 5. Data and Clock Input in 3-ChM (LS0 = low; LS1 = high)

POWERDOWN MODES

The SN65LVDS302 Receiver has two powerdown modes to facilitate efficient power management.

SHUTDOWN MODE

A low input signal on the RXEN pin puts the SN65LVDS302 into Shutdown mode. This turns off most of the receiver circuitry including the SubLVDS receivers, PLL, and deserializers. The subLVDS differential-input resistance remains 100 Ω , while any input signal is ignored. All outputs will hold a static output pattern:

$$R[0:7]=G[0:7]=B[0:7]=VS=HS=high; DE=PCLK=low.$$

The current draw in Shutdown mode will be nearly zero if the subLVDS inputs are left open or pulled high.

STANDBY MODE

The SN65LVDS302 will enter the Standby mode when the SN65LVDS302 is not in Shutdown mode but the SubLVDS clock-input common-mode voltage is above $0.9 \times V_{DDLVDs}$. The CLK input incorporates a pull-up circuit to shift the SubLVDS clock-input common-mode voltage to V_{DDLVDs} in the absence of an input signal. All circuitry except the SubLVDS clock-input Standby monitor is shut down. The SN65LVDS302 will also enter Standby mode when the input clock frequency on the CLK input is less than 500 kHz. The SubLVDS input resistance remains 100 Ω while any input signal on the data inputs D0, D1, and D2 becomes ignored. All outputs will hold a static output pattern:

$$R[0:7]=G[0:7]=B[0:7]=VS=HS=high; DE=PCLK=low.$$

The current drawn in Standby mode will be very low.

ACTIVE MODES

A high input signal on RXEN combined with a CLK input signal switching faster than 3 MHz and V_{ICM} smaller than 1.3 V force the SN65LVDS302 into Active mode. Current consumption in active mode depends on operating frequency and the number of data transitions in the data payload. CLK-input frequencies between 3 MHz and 4 MHz activate the device but proper PLL functionality is not secured. It is not recommended to operate the SN65LVDS302 in active mode at CLK frequencies below 4 MHz.

ACQUIRE MODE (PLL Approaches Lock)

When the SN65LVDS302 is enabled and a SubLVDS clock input present, the PLL will pursue lock to the input clock. While the PLL pursues lock the output data bus will hold a static output pattern:

$$R[0:7]=G[0:7]=B[0:7]=VS=HS=high; DE=PCLK=low.$$

For proper device operation, the pixel clock frequency must fall within the valid f_{PCLK} range specified under recommended operating conditions. If the pixel clock frequency is larger than 3 MHz but smaller than $f_{PCLK(min)}$, the SN65LVDS302 PLL is enabled. Under such conditions, it is possible for the PLL to lock temporarily to the pixel clock, causing the PLL monitor to release the device into active receive mode. If this happens, the PLL may or may not be properly locked to the pixel clock input, potentially causing data errors, frequency oscillation, and PLL deadlock (loss of VCO oscillation).

RECEIVE MODE

After the PLL achieves lock the device enters the normal receive mode. The output data bus presents the de-serialized data. The PCLK output pin outputs the recovered pixel clock.

PARITY ERROR DETECTION AND HANDLING

The SN65LVDS302 receiver performs error checking on the basis of a parity bit that is transmitted across the subLVDS interface from the transmitting device. Once the SN65LVDS302 detects the presence of the clock and the PLL has locked onto PCLK, then the parity is checked. Parity-error detection ensures detection of all single bit errors in one pixel and 50% of all multi-bit errors.

The parity bit covers the 27 bit data payload consisting of 24 bits of pixel data plus VS, HS, and DE. Odd Parity bit signalling is used. The parity error is output on the CPE pin. If the sum of the 27 data bits and the parity result in an odd number, the receive data are assumed to be valid. The CPE output will be held low. If the sum equals an even number, parity error is declared. The CPE output will indicate high for half a PCLK period. The CPE output will be set with the data bit transition and cleared after 1/2 the data bit time. This allows counting every detected parity error with a simple counter connected to CPE.

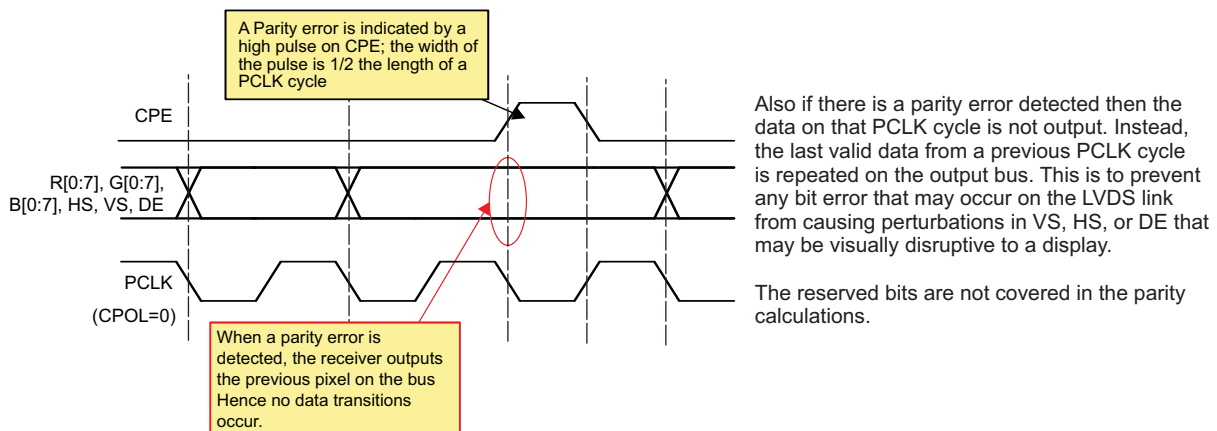

STATUS DETECT AND OPERATING MODES FLOW DIAGRAM

The SN65LVDS302 switches between the power saving and active modes in the following way:

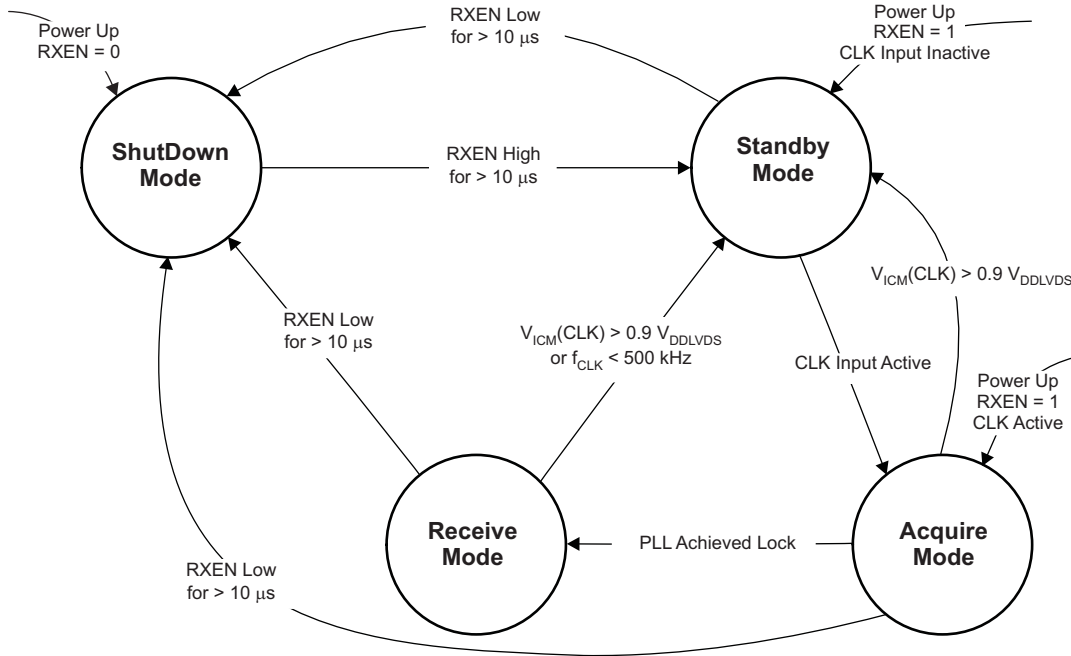

Table 3. Status Detect and Operating Modes Descriptions

Mode	Characteristics	Conditions
Shutdown Mode	Least amount of power consumption (most circuitry turned off); All outputs held static: R[0:7]=G[0:7]=B[0:7]=VS=HS=high DE=PCLK=low;	RXEN is set low for longer than 10μs ⁽¹⁾⁽²⁾
Standby Mode	Low power consumption (Standby monitor circuit active; PLL is shutdown to conserve power); All outputs held static: R[0:7]=G[0:7]=B[0:7]=VS=HS=high DE=PCLK=low;	RXEN is high for longer than 10 μs, and both CLK input common-mode $V_{ICM(CLK)}$ above $0.9 \times V_{DDLVDs}$, or CLK input floating ⁽²⁾
Acquire Mode	PLL pursues lock; All outputs held static: R[0:7]=G[0:7]=B[0:7]=VS=HS=high DE=PCLK=low;	RXEN is high; CLK input monitor detected clock input common mode and woke up receiver out of Standby mode
Receive Mode	Data transfer (normal operation); receiver deserializes data and provides data on parallel output	RXEN is high and PLL is locked to incoming clock

(1) In Shutdown Mode, all SN65LVDS302 internal switching circuits (e.g., PLL, serializer, etc.) are turned off to minimize power consumption. The input stage of any input pin remains active.
 (2) Leaving CMOS control inputs unconnected can cause random noise to toggle the input stage and potentially harm the device. All CMOS inputs must be tied to a valid logic level V_{IL} or V_{IH} during Shutdown or Standby Mode. Exceptions are the subLVDS inputs CLK and Dx, which can be left unconnected while not in use.

Table 4. Operating Mode Transitions

MODE TRANSITION	USE CASE	TRANSITION SPECIFICS
Shutdown → Standby	Drive RXEN high to enable receiver	<ol style="list-style-type: none"> 1. RXEN high > 10 μs 2. Receiver enters standby mode <ol style="list-style-type: none"> a. R[0:7]=G[0:7]=B[0:7]=VS=HS remain high and DE=PCLK low b. Receiver activates clock input monitor
Standby → Acquire	Transmitter activity detected	<ol style="list-style-type: none"> 1. CLK input monitor detects clock input activity 2. Outputs remain static 3. PLL circuit is enabled
Acquire → Receive	Link is ready to receive data	<ol style="list-style-type: none"> 1. PLL is active and approaches lock 2. PLL achieves lock within t_{wakeup} 3. D1, D2, and/or D3 become active depending on LS0 and LS1 selection 4. First Data word was recovered 5. Parallel output bus turns on switching from static output pattern to output first valid data word
Receive → Standby	Transmitter requested to enter Standby mode by input common mode voltage $V_{\text{ICM}} > 0.9 V_{\text{DDLVDs}}$ (e.g. transmitter output clock stops or enters high-impedance state)	<ol style="list-style-type: none"> 1. Receiver disables outputs within t_{sleep} 2. RX Input monitor detects $V_{\text{ICM}} > 0.9 V_{\text{DDLVDs}}$ within t_{sleep} 3. R[0:7]=G[0:7]=B[0:7]=VS=HS transition to high and DE=PCLK to low on next falling PLL clock edge 4. PLL shuts down. Clock activity input monitor remains active
Receive/Standby → Shutdown	Turn off Receiver	<ol style="list-style-type: none"> 1. RXEN pulled low for > t_{pwrdn} 2. R[0:7]=G[0:7]=B[0:7]=VS=HS remain static high or transition to static high and DE=PCLK remain or transition to static low 3. Most IC circuitry is shut down for least power consumption

ABSOLUTE MAXIMUM RATINGS⁽¹⁾

		VALUE	UNIT
Supply voltage range, V_{DD} ⁽²⁾ , V_{DDPLLA} , V_{DDPLLD} , V_{DDLVDs}		-0.3 to 2.175	V
Voltage range at any input or output terminal	When $V_{DDx} > 0$ V	-0.5 to 2.175	V
	When $V_{DDx} \leq 0$ V	-0.5 to $V_{DD} + 2.175$	
Electrostatic discharge	Human Body Model ⁽³⁾ (all Pins)	± 4	kV
	Charged-Device Mode ⁽⁴⁾ (all Pins)	± 1500	V
	Machine Model ⁽⁵⁾ (all pins)	± 200	
Continuous power dissipation		See Dissipation Rating Table	
Output current, I_O		± 5	mA

(1) Stresses beyond those listed under *absolute maximum ratings* may cause permanent damage to the device. These are stress ratings only and functional operation of the device at these or any other conditions beyond those indicated under *recommended operating conditions* is not implied. Exposure to absolute maximum-rated conditions for extended periods may affect device reliability.

- (2) All voltage values are with respect to the GND terminals
 (3) In accordance with JEDEC Standard 22, Test Method A114-B
 (4) In accordance with JEDEC Standard 22, Test Method C101
 (5) In accordance with JEDEC Standard 22, Test Method A115-A

DISSIPATION RATINGS

PACKAGE	CIRCUIT BOARD MODEL	$T_A < 25^\circ\text{C}$	DERATING FACTOR ⁽¹⁾ ABOVE $T_A = 25^\circ\text{C}$	$T_A = 85^\circ\text{C}$ POWER RATING
ZQE	Low-K ⁽²⁾	592 mW	7.407 mW/ $^\circ\text{C}$	148 mW

- (1) This is the inverse of the junction-to-ambient thermal resistance when board-mounted and with no air flow.
 (2) In accordance with the Low-K thermal metric definitions of EIA/JESD51-2.

DEVICE POWER DISSIPATION

PARAMETER	TEST CONDITIONS		TYP	MAX	UNIT
P_D Device Power Dissipation	$V_{DDx} = 1.8$ V, $T_A = 25^\circ\text{C}$, all outputs terminated with 10 pF	f_{CLK} at 4 MHz	16.8		mW
		f_{CLK} at 65 MHz	64.7		
	$V_{DDx} = 1.95$ V, $T_A = -40^\circ\text{C}$, all outputs terminated with 10 pF	f_{CLK} at 4 MHz		27.4	mW
		f_{CLK} at 65 MHz		128.8	

RECOMMENDED OPERATING CONDITIONS⁽¹⁾

		MIN	TYP	MAX	UNIT	
V_{DD} V_{DDPLLA} $V_{DDPLL D}$ $V_{DDL VDS}$	Supply voltages	1.65	1.8	1.95	V	
$V_{DDn(PP)}$	Supply voltage noise magnitude 50MHz (all supplies)	Test set-up see Figure 7			mV	
		$f_{CLK} \leq 50\text{MHz}$; $f(\text{noise}) = 1\text{Hz to } 2\text{GHz}$		100		
		$f_{CLK} > 50\text{MHz}$; $f(\text{noise}) = 1\text{Hz to } 1\text{MHz}$		100		
$f_{CLK} > 50\text{MHz}$; $f(\text{noise}) > 1\text{MHz}$				40		
T_A	Operating free-air temperature	-40		85	°C	
CLK+ and CLK-						
$f_{CLK\pm}$	Input Pixel clock frequency	1-Channel receive mode, see Figure 3		4	15	MHz
		2-Channel receive mode, see Figure 4		8	30	
		3-Channel receive mode, see Figure 5		20	65	
		Standby mode ⁽²⁾ , See Figure 16				500
t_{DUTCLK}	CLK Input Duty Cycle		35	65	%	
D0+, D0-, D1+, D1-, D2+, D2-, CLK+, and CLK-						
$ V_{ID} $	Magnitude of differential input voltage	$ V_{D0+}-V_{D0-} $, $ V_{D1+}-V_{D1-} $, $ V_{D2+}-V_{D2-} $, $ V_{CLK+}-V_{CLK-} $ during normal operation		70	200	mV
V_{ICM}	Input Voltage Common Mode Range	Receive or Acquire mode		0.6	1.2	V
		Stand-by mode		$0.9 \times V_{DDL VDS}$		
ΔV_{ICM}	Input Voltage Common Mode Variation between all SubLVDS inputs	$V_{ICM(n)} - V_{ICM(m)}$ with $n=D0, D1, D2$, or CLK and $m=D0, D1, D2$, or CLK		-100	100	mV
ΔV_{ID}	Differential Input Voltage Amplitude Variation between all SubLVDS inputs	$V_{ID(n)} - V_{ID(m)}$ with $n=D0, D1, D2$, or CLK and $m=D0, D1, D2$, or CLK		-10	10	%
$t_{R/F}$	Input Rise and Fall Time	RXEN at VDD; see figure 6-2			800	ps
$\Delta t_{R/F}$	Input Rise or Fall Time mismatch between all SubLVDS inputs	$t_{R(n)} - t_{R(m)}$ and $t_{F(n)} - t_{F(m)}$ with $n=D0, D1, D2$, or CLK and $m=D0, D1, D2$, or CLK		-100	100	ps
LS0, LS1, CPOL, SWAP, RXEN, F/S						
V_{ICMOSH}	High-level input voltage	$0.7 \times V_{DD}$		V_{DD}		V
V_{ICMOSL}	Low-level input voltage	0		$0.3 \times V_{DD}$		V
t_{inRXEN}	RXEN input pulse duration	10				µs
R[7:0], G[7:0], B[7:0], VS, HS, PCLK, CPE						
C_L	Output load capacitance			10		pF

(1) Unused single-ended inputs must be held high or low to prevent them from floating.

(2) PCLK input frequencies lower than 500 kHz force the SN65LVDS302 into standby mode. Input frequencies between 500 kHz and 3 MHz may or may not activate the SN65LVDS302. Input frequencies beyond 3 MHz activate the SN65LVDS302. Input frequencies between 500 kHz and 4 MHz are not recommended, and can cause PLL malfunction.

DEVICE ELECTRICAL CHARACTERISTICS

over recommended operating conditions (unless otherwise noted)

PARAMETER	TEST CONDITIONS		MIN	TYP ⁽¹⁾	MAX	UNIT
I _{DD} RMS Supply Current	1ChM	Alternating 1010 Test pattern (see Table 9); All CMOS outputs terminated with 10 pF; F/S and RXEN at V _{DD} ; V _{IH} =V _{DD} , V _{IL} =0 V; V _{DD} =V _{DDPLL} =V _{DDPLL} =V _{DDLVD} ;	f _{PCLK} = 4 MHz	9.8	14.0	mA
			f _{PCLK} = 6 MHz	11.7	15.9	
			f _{PCLK} = 15 MHz	19.3	25.0	
		Typical power test pattern (see Table 6); V _{ID} =70 mV, All CMOS outputs terminated with 10 pF; F/S at GND and RXEN at V _{DD} ; V _{IH} =V _{DD} , V _{IL} =0 V; V _{DD} =V _{DDPLL} =V _{DDPLL} =V _{DDLVD} ;	f _{PCLK} = 4 MHz	4.7	mA	
			f _{PCLK} = 6 MHz	6.0		
			f _{PCLK} = 15 MHz	13.2		
	2ChM	Alternating 1010 Test pattern (see Table 9); All CMOS outputs terminated with 10 pF; F/S and RXEN at V _{DD} ; V _{IH} =V _{DD} , V _{IL} =0 V; V _{DD} =V _{DDPLL} =V _{DDPLL} =V _{DDLVD} ;	f _{PCLK} = 8 MHz	14.3	19.4	mA
			f _{PCLK} = 22 MHz	25.0	33.0	
			f _{PCLK} = 30 MHz	26.8	37.0	
		Typical power test pattern (see Table 7); V _{ID} =70 mV, All CMOS outputs terminated with 10 pF; F/S at GND and RXEN at V _{DD} ; V _{IH} =V _{DD} , V _{IL} =0 V; V _{DD} =V _{DDPLL} =V _{DDPLL} =V _{DDLVD} ;	f _{PCLK} = 8 MHz	6.4	mA	
			f _{PCLK} = 22 MHz	13.7		
			f _{PCLK} = 30 MHz	18.3		
3ChM	Alternating 1010 Test pattern (see Table 9); All CMOS outputs terminated with 10 pF; F/S and RXEN at V _{DD} ; V _{IH} =V _{DD} , V _{IL} =0 V; V _{DD} =V _{DDPLL} =V _{DDPLL} =V _{DDLVD} ;	f _{PCLK} = 20 MHz	17.1	27.0	mA	
		f _{PCLK} = 65 MHz	60.8	68.0		
		f _{PCLK} = 20 MHz	8.6	mA		
	Typical power test pattern (see Table 8); V _{ID} =70 mV, All CMOS outputs terminated with 10 pF; F/S at GND and RXEN at V _{DD} ; V _{IH} =V _{DD} , V _{IL} =0 V; V _{DD} =V _{DDPLL} =V _{DDPLL} =V _{DDLVD} ;	f _{PCLK} = 65 MHz	22.2			
		CLK and D[0:2] inputs are left open; All control inputs held static high or low; All CMOS outputs terminated with 10 pF; V _{IH} =V _{DD} , V _{IL} =0V; V _{DD} =V _{DDPLL} =V _{DDPLL} =V _{DDLVD}	Standby mode; RXEN=V _{IH}		15	100
			Shutdown mode; RXEN=V _{IL}	0.4	10	μA

(1) All typical values are at 25°C and with 1.8 V supply unless otherwise noted.

INPUT ELECTRICAL CHARACTERISTICS

over operating free-air temperature range (unless otherwise noted)

PARAMETER	TEST CONDITIONS	MIN	TYP ⁽¹⁾	MAX	UNIT	
D0+, D0-, D1+, D1-, D2+, D2-, CLK+, and CLK-						
V _{thstby}	Input voltage common mode threshold to switch between receive/acquire mode and standby mode	RXEN at V _{DD}		1.3	0.9×V _{DDLVDs}	V
V _{THL}	Low-level differential input voltage threshold	V _{D0+–V_{D0–}} , V _{D1+–V_{D1–}} , V _{D2+–V_{D2–}} , V _{CLK+–V_{CLK–}}		–40		mV
V _{THH}	High-level differential input voltage threshold				40	mV
I _{I+} , I _{I–}	Input leakage current	V _{DD} =1.95 V; V _{I+} = V _{I–} ; V _I = 0.4 V and V _I = 1.5 V			75	μA
I _{IOFF}	Power-off input current	V _{DD} =GND; V _I = 1.5V			–75	μA
R _{ID}	Differential input termination resistor value		78	100	122	Ω
C _{IN}	Input capacitance	Measured between input terminal and GND			1	pF
ΔC _{IN}	Input capacitance variation	Within one signal pair Between all signals			0.2 1	pF
R _{BBDC}	Pull-up resistor for standby detection		21	30	39	kΩ
LS0, LS1, CPOL, SWAP, RXEN, F/S						
V _{IK}	Input clamp voltage	I _I = –18 mA, V _{DD} =V _{DD} (min)			–1.2	V
I _{ICMOS}	Input current ⁽²⁾	0 V ≤ V _{DD} ≤ 1.95 V; V _I =GND or V _I =1.95 V			100	nA
C _{IN}	Input capacitance				2	pF
I _{IH}	High-level input current	V _{IN} = 0.7 × V _{DD}		–200	200	nA
I _{IL}	Low-level input current	V _{IN} = 0.3 × V _{DD}		–200	200	
V _{IH}	High-level input voltage			0.7×V _{DD}	V _{DD}	V
V _{IL}	Low-level input voltage			0	0.3×V _{DD}	

(1) All typical values are at 25°C and with 1.8 V supply unless otherwise noted.

(2) Do not leave any CMOS Input unconnected or floating to minimize leakage currents. Every input must be connected to a valid logic level V_{IH} or V_{OL} while power is supplied to V_{DD}.

OUTPUT ELECTRICAL CHARACTERISTICS

over operating free-air temperature range (unless otherwise noted)

PARAMETER	TEST CONDITIONS	MIN	TYP	MAX	UNIT	
R[0:7], G[0:7], B[0:7], VS, HS, PCLK, CPE						
V _{OH}	High-level output current	1-ChM, F/S=L, I _{OH} =–250 μA		0.8×V _{DD}	V _{DD}	V
		2- or 3-ChM, F/S=L, I _{OH} =–500 μA				
		1-ChM, F/S=H, I _{OH} =–500 μA				
		2- or 3-ChM, F/S=H, I _{OH} =–2.0 mA				
V _{OL}	Low-level output current	1-ChM, F/S=L, I _{OL} =250 μA		0	0.2×V _{DD}	V
		2- or 3-ChM, F/S=L, I _{OL} =500 μA				
		1-ChM, F/S=H, I _{OL} =500 μA				
		2- or 3-ChM, F/S=H, I _{OL} =2.0 mA				
I _{OH}	High-level output current	1-ChM, F/S=L		–250		μA
		2- or 3-ChM, F/S=L; 1-ChM, F/S=H		–500		
		2- or 3-ChM, F/S=H		–2000		
I _{OL}	Low-level output current	1-ChM, F/S=L			250	
		2- or 3-ChM, F/S=L; 1-ChM, F/S=H			500	
		2- or 3-ChM, F/S=H			2000	

SWITCHING CHARACTERISTICS

over recommended operating conditions (unless otherwise noted)

PARAMETER		TEST CONDITIONS	MIN	TYP ⁽¹⁾	MAX	UNIT	
D0+, D0–, D1+, D1–, D2+, D2–, CLK+, and CLK–							
$t_{R/F}$	Input rise and fall time	RXEN at V_{DD} ; see figure 6-2			800	ps	
$\Delta t_{R/F}$	Input rise or fall time mismatch between all SubLVDS inputs	$t_R(n) - t_R(m)$ and $t_F(n) - t_F(m)$ with $n=D0, D1, D2$, or CLK and $m=D0, D1, D2$, or CLK	–100		100	ps	
R[7:0], G[7:0], B[7:0], VS, HS, PCLK, CPE							
$t_{R/F}$	Rise and fall time 20%–80% of V_{DD} ⁽²⁾	$C_L = 10$ pF ⁽³⁾ ; see Figure 9	1-channel mode, F/S=L		8	16	ns
			2-channel mode, F/S=L		4	8	
			3-channel mode, F/S=L		4	8	
			1-channel mode, F/S=H		4	8	
			2-channel mode, F/S=H		1	2	
			3-channel mode, F/S=H		1	2	
t_{OUTP}	PCLK output duty cycle	1-channel and 3-channel mode		45%	50%	55%	
		CPOL= V_{IL} , 2-channel mode		48%	53%	59%	
		CPOL= V_{IH} , 2-channel mode		41%	47%	52%	
t_{OSK}	Output skew between PCLK and R[0:7], G[0:7], B[0:7], HS, VS, and DE	see Figure 9	–500		500	ps	
INPUT TO OUTPUT RESPONSE TIME							
$t_{PD(L)}$	Propagation delay time from CLK+ input to PCLK output	RXEN at V_{DD} , $V_{IH}=V_{DD}$, $V_{IL}=GND$, $C_L=10$ pF, See Figure 14	$1.4/f_{PCLK}$	$1.9/f_{PCLK}$	$2.5/f_{PCLK}$	s	
t_{GS}	RXEN glitch suppression pulse width ⁽⁴⁾	$V_{IH}=V_{DD}$, $V_{IL}=GND$, RXEN toggles between V_{IL} and V_{IH} ; See Figure 15 and Figure 16			3.8	μ s	
t_{pwrap}	Enable time from power down (\uparrow RXEN)	Time from RXEN pulled high to data outputs enabled and outputs valid data; See Figure 16			2	ms	
t_{pwrdn}	Disable time from active mode (\downarrow RXEN)	RXEN is pulled low during receive mode; time measurement until all outputs held static; R[0:7]=G[0:7]=B[0:7]=VS=HS=high, DE=PCLK=low and PLL is Shutdown; See Figure 16			11	μ s	
t_{wakeup}	Enable time from Standby (\uparrow CLK)	RXEN at V_{DD} ; device is in standby; time measurement from CLK input starts switching to PCLK and data outputs enabled and outputting valid data; See Figure 17			2	ms	
t_{sleep}	Disable time from active mode (CLK transitions to high-impedance)	RXEN at V_{DD} ; device is receiving data; time measurement from CLK input signal stops (input open or input common mode VICM exceeds threshold voltage V_{thstby}) until all outputs held static; R[0:7]=G[0:7]=B[0:7]=VS=HS=high, DE=PCLK=low and PLL is Shutdown; See Figure 17			3	μ s	
f_{BW}	PLL bandwidth ⁽⁵⁾	Tested from CLK input to PCLK output	2-ChM; $f_{PCLK}=22$ MHz		$0.087 \times f_{PCLK}$	MHz	
			3-ChM; $f_{PCLK}=65$ MHz		$0.075 \times f_{PCLK}$		

- (1) All typical values are at 25°C and with 1.8 V supply unless otherwise noted.
- (2) $t_{R/F}$ depends on the F/S setting and the capacitive load connected to each output. Some application information of how to calculate $t_{R/F}$ based on the output load and how to estimate the timing budget to interconnect to an LCD driver are provided in the application section near the end of this data sheet.
- (3) The output rise and fall time is optimized for an output load of 10 pF. The rise and fall time can be adjusted by changing the output load capacitance.
- (4) The RXEN input incorporates a glitch-suppression logic to disregard short input pulses. t_{GS} is the duration of either a high-to-low or low-to-high transition that is suppressed.
- (5) When using the SN65LVDS302 receiver in conjunction with the SN65LVDS301 transmitter in one link, the PLL bandwidth of the SN65LVDS302 receiver always exceed the bandwidth of the SN65LVDS301 transmit PLL. This ensures stable PLL tracking under all operating conditions and maximizes the receiver skew margin.

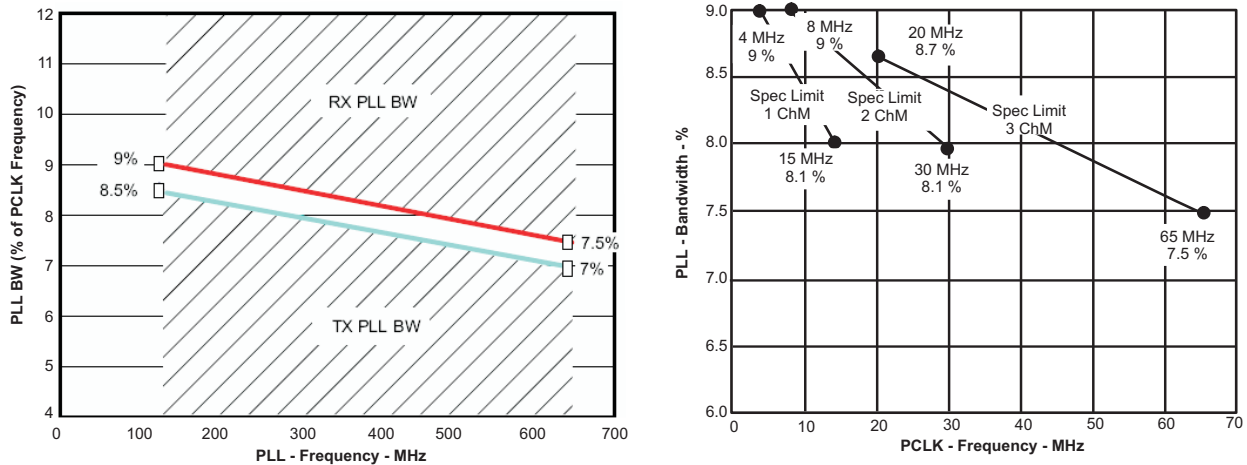

Figure 6. SN65LVDS302 PLL Bandwidth (also showing the SN65LVDS301 PLL bandwidth)

TIMING CHARACTERISTICS

PARAMETER	TEST CONDITIONS	MIN	MAX	UNIT
t_{RSKMx} (1)(2) Receiver input skew margin; see (3) and Figure 43	1ChM: $x=0.29$, $f_{PCLK}=15$ MHz; RXEN at V_{DD} , $V_{IH}=V_{DD}$, $V_{IL}=GND$, $R_L=100\ \Omega$, test setup as in Figure 8, test pattern as in Table 11	$f_{CLK}=15$ MHz ⁽⁴⁾ $f_{CLK}=4$ MHz to 15 MHz ⁽⁵⁾	630 $\frac{1}{2 \cdot 30 \cdot f_{CLK}} - 480$ ps	ps
	2ChM: $x = 0.14$, $f_{PCLK} = 30$ MHz RXEN at V_{DD} , $V_{IH}=V_{DD}$, $V_{IL}=GND$, $R_L=100\ \Omega$, test setup as in Figure 8, test pattern as in Table 12	$f_{CLK}=30$ MHz ⁽⁴⁾ $f_{CLK}=8$ MHz to 30 MHz ⁽⁵⁾	630 $\frac{1}{2 \cdot 15 \cdot f_{CLK}} - 480$ ps	
	3ChM: RXEN at V_{DD} , $V_{IH}=V_{DD}$, $V_{IL}=GND$, test setup as in Figure 8, test pattern as in Table 13	$f_{CLK}=65$ MHz ⁽⁴⁾ $f_{CLK} = 20$ MHz to 65 MHz ⁽⁵⁾	360 $\frac{1}{2 \cdot 10 \cdot f_{CLK}} - 410$ ps	

- (1) Receiver Input Skew Margin (t_{RSKM}) is the timing margin available for transmitter output pulse position (t_{PPOS}), interconnect skew, and interconnect inter-symbol interference. t_{RSKM} represents the remainder of the serial bit time not taken up by the receiver strobe uncertainty. The t_{RSKM} assumes a bit error rate better than 10^{-12} .
- (2) t_{RSKM} is indirectly proportional to the internal set-up and hold time uncertainty, ISI and duty cycle distortion from the front end receiver, the skew mismatch between CLK and data D0, D1, and D2, as well as the PLL cycle-to-cycle jitter.
- (3) This includes the receiver internal set-up and hold time uncertainty, all PLL related high-frequency random and deterministic jitter components that impact the jitter budget, ISI and duty cycle distortion from the front end receiver, and the skew between CLK and data D0, D1, and D2; The pulse position min/max variation is given with a bit error rate target of 10^{-12} ; Measurements of the total jitter are taken over a sample amount of $> 10^{-12}$ samples.
- (4) The Minimum and Maximum Limits are based on statistical analysis of the device performance over process, voltage, and temp ranges.
- (5) These Minimum and Maximum Limits are simulated only.

PARAMETER MEASUREMENT INFORMATION

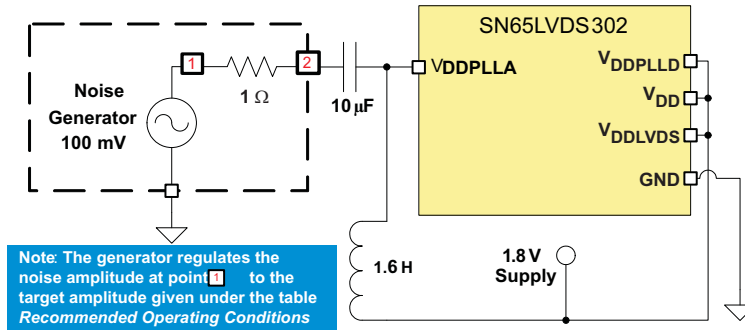

Figure 7. Power Supply Noise Test Set-Up

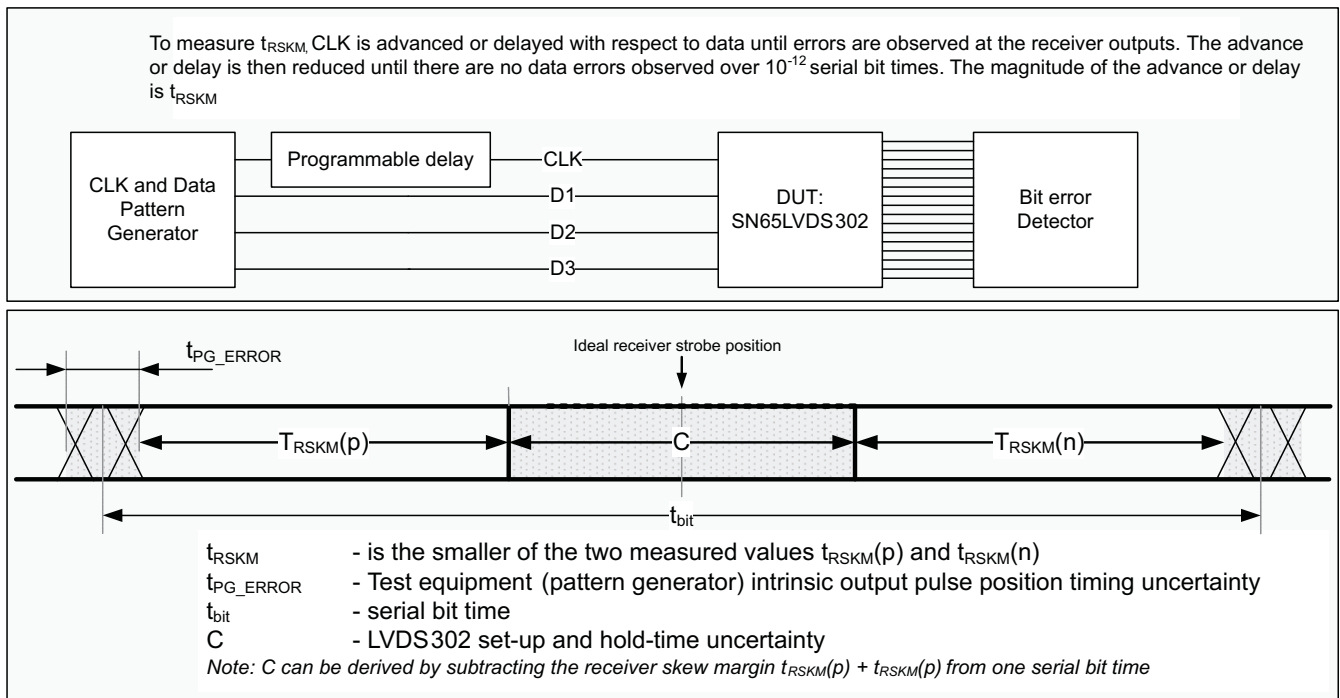

Figure 8. Jitter Budget

PARAMETER MEASUREMENT INFORMATION (continued)

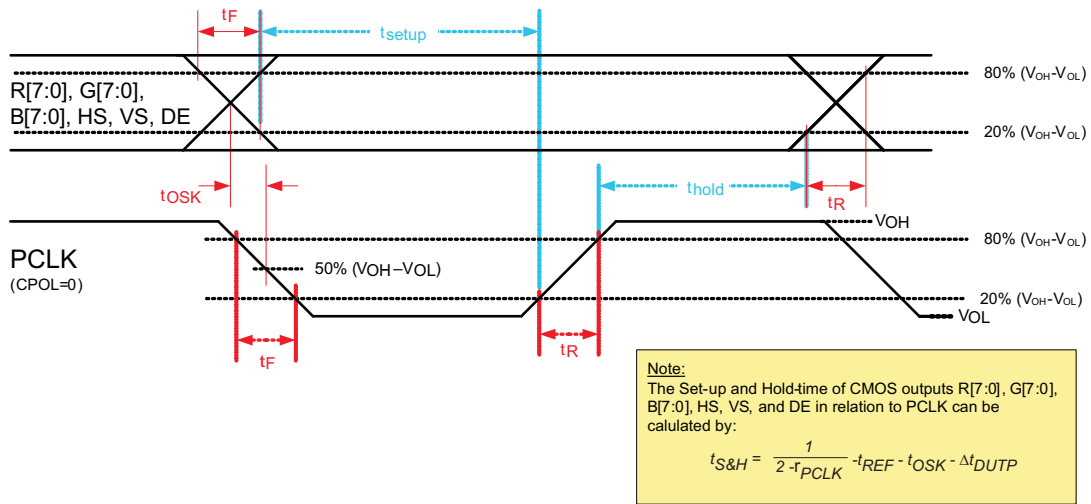

Figure 9. Output Rise/Fall, Setup/Hold Time

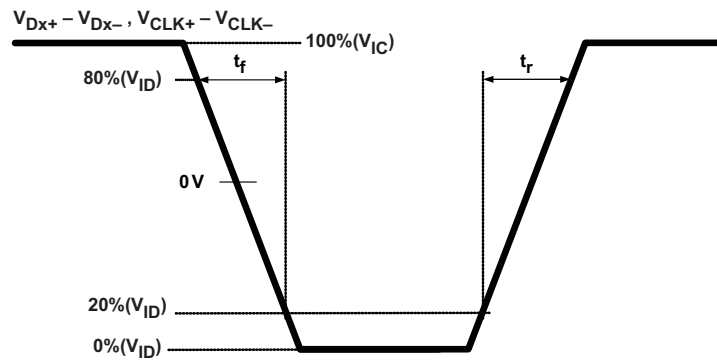

Figure 10. SubLVDS Differential Input Rise and Fall Time Definition

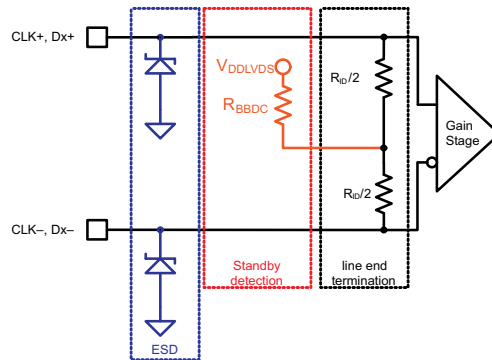

Figure 11. Equivalent Input Circuit Design

PARAMETER MEASUREMENT INFORMATION (continued)

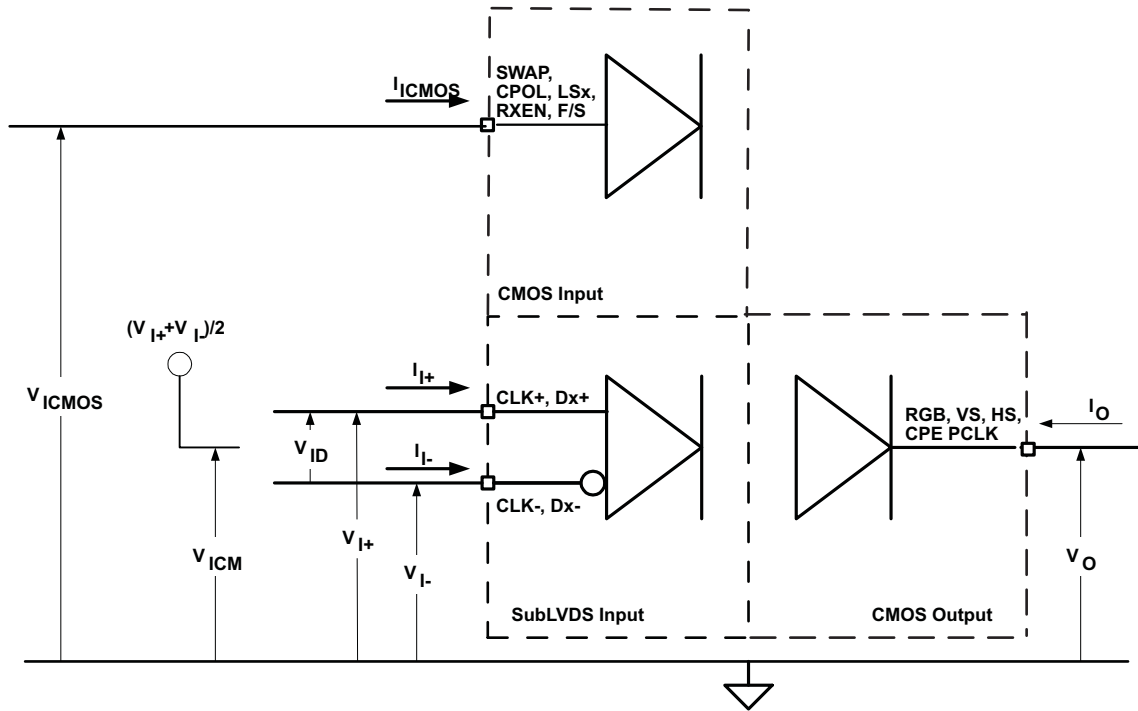

Figure 12. I/O Voltage and Current Definition

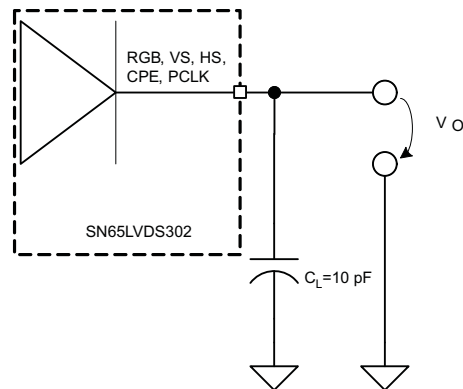

Figure 13. CMOS Output Test Circuit, Signal and Timing Definition

PARAMETER MEASUREMENT INFORMATION (continued)

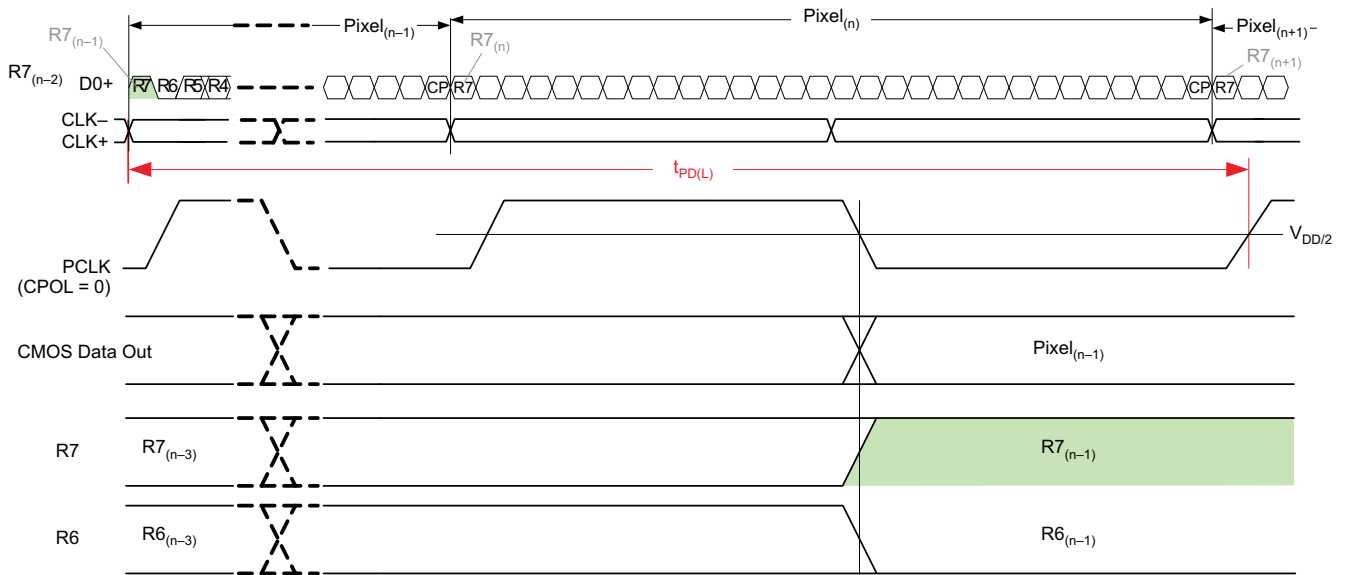

Figure 14. Propagation Delay Input to Output (LS0=LS1=0)

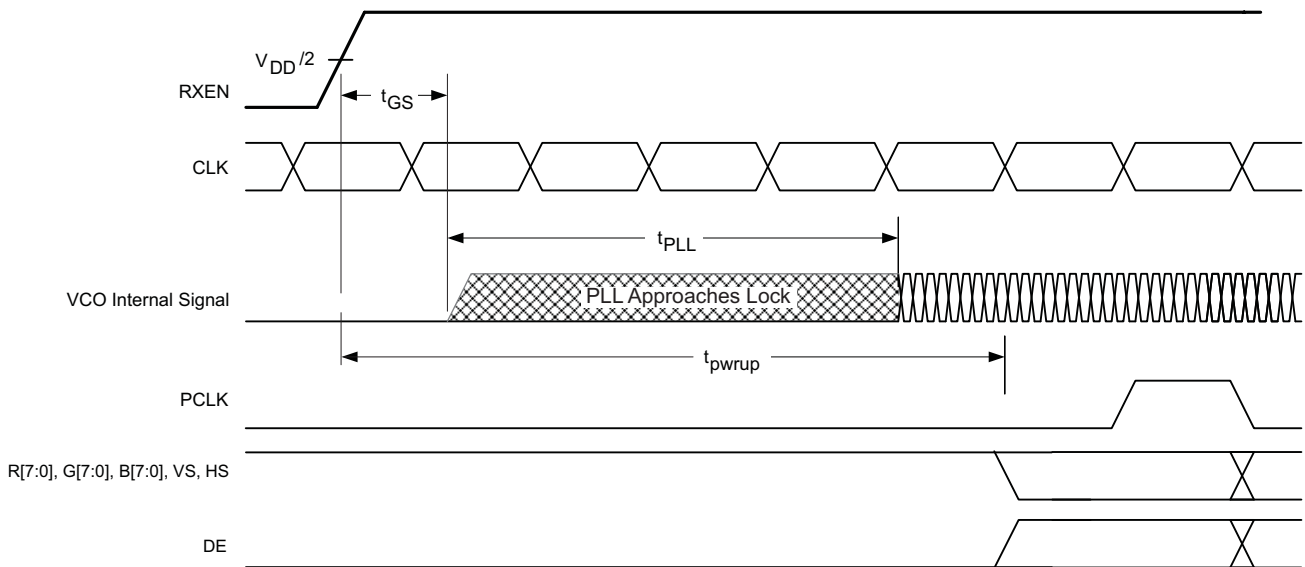

Figure 15. Receiver Phase Lock Loop Set Time and Receiver Enable Time

PARAMETER MEASUREMENT INFORMATION (continued)

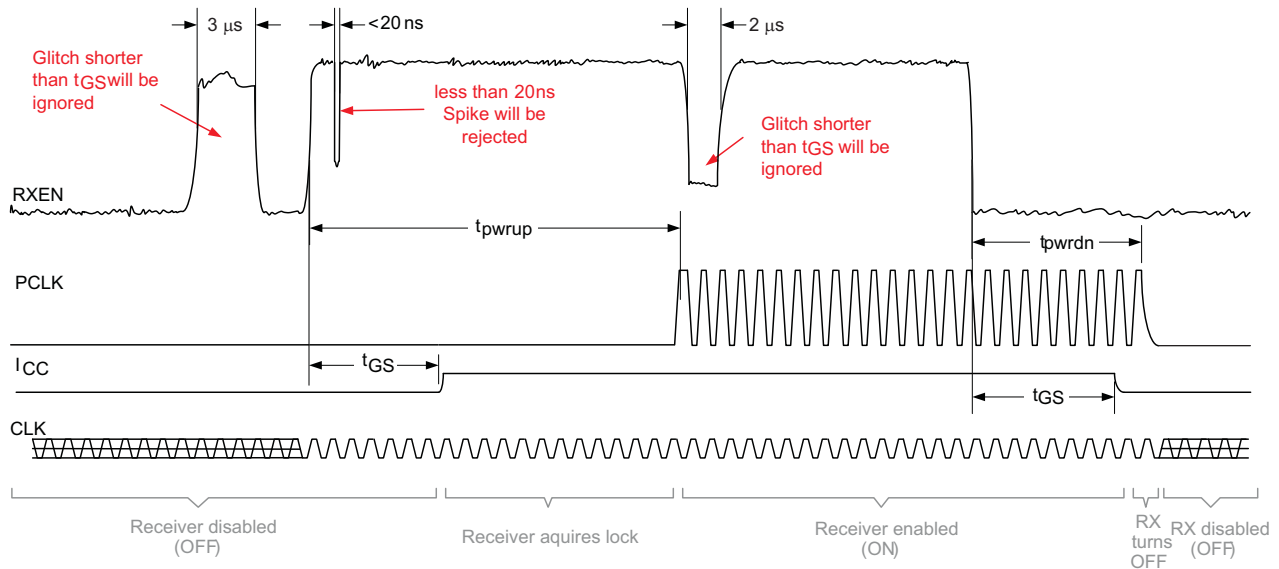

Figure 16. Receiver Enable/Disable Glitch Suppression Time

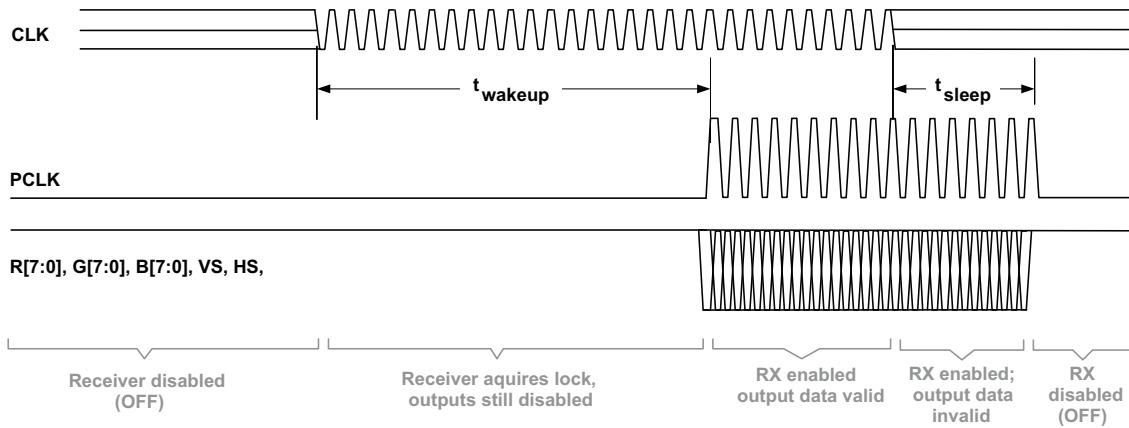

Figure 17. Standby Detection

POWER CONSUMPTION TESTS

Table 5 shows an example test pattern word.

Table 5. Example Test Pattern Word

Word	R[7:4], R[3:0], G[7:4], G[3:0], B[7:4], B[3:0], 0,VS,HS,DE
1	0x7C3E1E7

7				C				3				E				1				E				7			
R7	R6	R5	R4	R3	R2	R1	R0	G7	G6	G5	G4	G3	G2	G1	G0	B7	B6	B5	B4	B3	B2	B1	B0	0	VS	HS	DE
0	1	1	1	1	1	0	0	0	0	1	1	1	1	1	0	0	0	0	1	1	1	1	0	0	1	1	1

TYPICAL IC POWER CONSUMPTION TEST PATTERN

Typical power-consumption test patterns consist of sixteen 30-bit receive words in 1-channel mode, eight 30-bit receive words in 2-channel mode and five 30-bit receive words in 3-channel mode. The pattern repeats itself throughout the entire measurement. It is assumed that every possible code on the RGB outputs has the same probability to occur during typical device operation.

Table 6. Typical IC Power Consumption Test Pattern, 1-Channel Mode

Word	Test Pattern: R[7:4], R[3:0], G[7:4], G[3:0], B[7-4], B[3-0], 0,VS,HS,DE
1	0x0000007
2	0xFFFF007
3	0x01FFF47
4	0xF0E07F7
5	0x7C3E1E7
6	0xE707C37
7	0xE1CE6C7
8	0xF1B9237
9	0x91BB347
10	0xD4CCC67
11	0xAD53377
12	0xACB2207
13	0xAAB2697
14	0x5556957
15	0xAAAAAB3
16	0xAAAAAA5

Table 7. Typical IC Power Consumption Test Pattern, 2-Channel Mode

Word	Test Pattern: R[7:4], R[3:0], G[7:4], G[3:0], B[7-4], B[3-0], 0,VS,HS,DE
1	0x0000001
2	0x03F03F1
3	0xBFFBFF1
4	0x1D71D71
5	0x4C74C71
6	0xC45C451
7	0xA3aA3A5
8	0x5555553

Table 8. Typical IC Power Consumption Test Pattern, 3-Channel Mode

Word	Test Pattern: R[7:4], R[3:0], G[7:4], G[3:0], B[7-4], B[3-0], 0,VS,HS,DE
1	0xFFFFFFFF1
2	0x0000001
3	0xF0F0F01
4	0xCCCCC1
5	0xAAAAAA7

MAXIMUM POWER CONSUMPTION TEST PATTERN

The maximum (or worst-case) power consumption of the SN65LVDS302 is tested using the two different test patterns shown in table. Test patterns consist of sixteen 30-bit receive words in 1-channel mode, eight 30-bit receive words in 2-channel mode, and five 30-bit receive words in 3-channel mode. The pattern repeats itself throughout the entire measurement. It is assumed that every possible code on RGB outputs has the same probability to occur during typical device operation.

Table 9. Worst-Case Power Consumption Test Pattern

Word	Test Pattern: R[7:4], R[3:0], G[7:4], G[3:0], B[7-4], B[3-0], 0,VS,HS,DE
1	0xAAAAA5
2	0x555555

Table 10. Worst-Case Power Consumption Test Pattern

Word	Test Pattern: R[7:4], R[3:0], G[7:4], G[3:0], B[7-4], B[3-0], 0,VS,HS,DE
1	0x000000
2	0xFFFFF7

OUTPUT SKEW PULSE POSITION and JITTER PERFORMANCE

The following test patterns are used to measure the output skew pulse position and the jitter performance of the SN65LVDS302. The jitter test pattern stresses the interconnect, particularly to test for ISI, using very long run-lengths of consecutive bits, and incorporating very high and low data rates, maximizing switching noise. Each pattern is self-repeating for the duration of the test.

Table 11. Receive Jitter Test Pattern, 1-Channel Mode

Word	Test Pattern: R[7:4], R[3:0], G[7:4], G[3:0], B[7-4], B[3-0], 0,VS,HS,DE
1	0x0000001
2	0x0000031
3	0x00000F1
4	0x00003F1
5	0x0000FF1
6	0x0003FF1
7	0x000FFF1
8	0x0F0F0F1
9	0x0C30C31
10	0x0842111
11	0x1C71C71
12	0x18C6311
13	0x1111111
14	0x3333331
15	0x2452413
16	0x22A2A25
17	0x5555553
18	0xDB6DB65
19	0xCCCCC1
20	0xEEEEE1
21	0xE739CE1
22	0xE38E381

Table 11. Receive Jitter Test Pattern, 1-Channel Mode (continued)

Word	Test Pattern: R[7:4], R[3:0], G[7:4], G[3:0], B[7-4], B[3-0], 0,VS,HS,DE
23	0xF7BDEE1
24	0xF3CF3C1
25	0xF0F0F01
26	0xFFF0001
27	0xFFFC001
28	0xFFFF001
29	0xFFFFC01
30	0xFFFFF01
31	0xFFFFFC1
32	0xFFFFF1

Table 12. Receive Jitter Test Pattern, 2-Channel Mode

Word	Test Pattern: R[7:4], R[3:0], G[7:4], G[3:0], B[7-4], B[3-0], 0,VS,HS,DE
1	0x0000001
2	0x000FFF3
3	0x8008001
4	0x0030037
5	0xE00E001
6	0x00FF001
7	0x007E001
8	0x003C001
9	0x0018001
10	0x1C7E381
11	0x3333331
12	0x555AAA5
13	0x6DBDB61
14	0x7777771
15	0x555AAA3
16	0xAAAAAA5
17	0x5555553
18	0xAAA5555
19	0x8888881
20	0x9242491
21	0xAAA5571
22	0xCCCCCC1
23	0xE3E1C71
24	0xFFE7FF1
25	0xFFC3FF1
26	0xFF81FF1
27	0xFE00FF1
28	0x1FF1FF1
29	0xFFCFFC3
30	0x7FF7FF1
31	0xFFF0007
32	0xFFFFFFFF1

Table 13. Receive Jitter Test Pattern, 3-Channel Mode

Word	Test Pattern: R[7:4], R[3:0], G[7:4], G[3:0], B[7-4], B[3-0], 0,VS,HS,DE
1	0x0000001
2	0x0000001
3	0x0000003
4	0x0101013
5	0x0303033
6	0x0707073
7	0x1818183
8	0xE7E7E71
9	0x3535351
10	0x0202021
11	0x5454543

Table 13. Receive Jitter Test Pattern, 3-Channel Mode (continued)

Word	Test Pattern: R[7:4], R[3:0], G[7:4], G[3:0], B[7-4], B[3-0], 0,VS,HS,DE
12	0xA5A5A51
13	0xADADAD1
14	0x5555551
15	0xA6A2AA3
16	0xA6A2AA5
17	0x5555553
18	0x5555555
19	0xAAAAAA1
20	0x5252521
21	0x5A5A5A1
22	0xABABAB1
23	0xFDFCFD1
24	0xCAAACA1
25	0x1818181
26	0xE7E7E71
27	0xF8F8F81
28	0xFCFCFC1
29	0xFEFEFE1
30	0xFFFFFFFF1
31	0xFFFFFFFF5
32	0xFFFFFFFF5

TYPICAL CHARACTERISTIC CURVES

Some of the plots in this section show more than one curve representing various device pin relationships. Taken together, they represent a working range for the tested parameter.

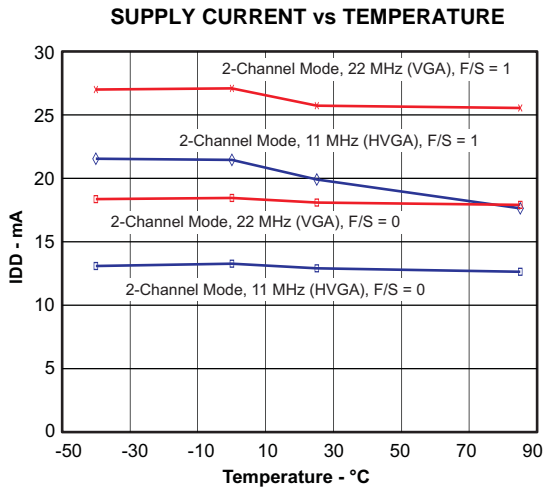

Figure 18.

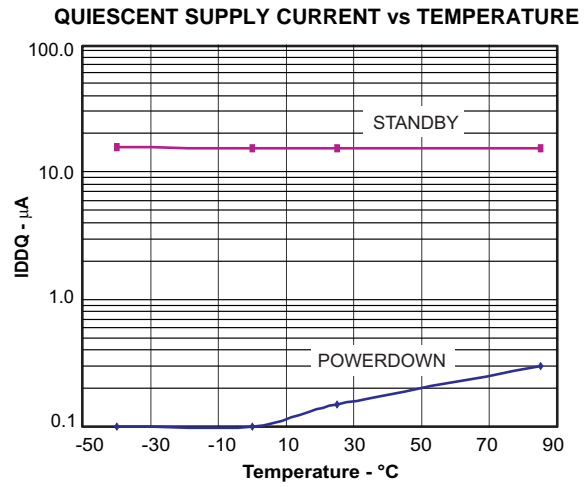

Figure 19.

SUPPLY CURRENT vs FREQUENCY, 1-CHANNEL MODE

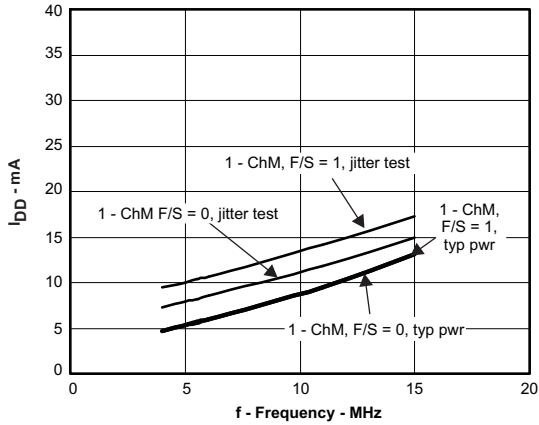

Figure 20.

SUPPLY CURRENT vs FREQUENCY, 2-CHANNEL MODE

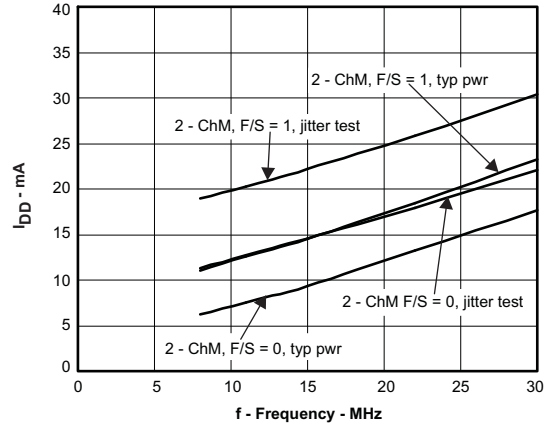

Figure 21.

SUPPLY CURRENT vs FREQUENCY, 3-CHANNEL MODE

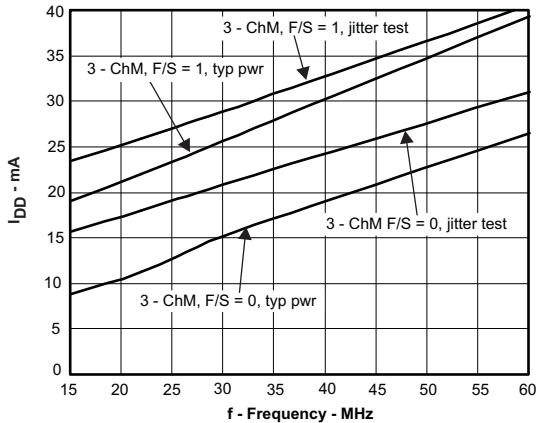

Figure 22.

RECEIVER STROBE POSITION vs TEMPERATURE

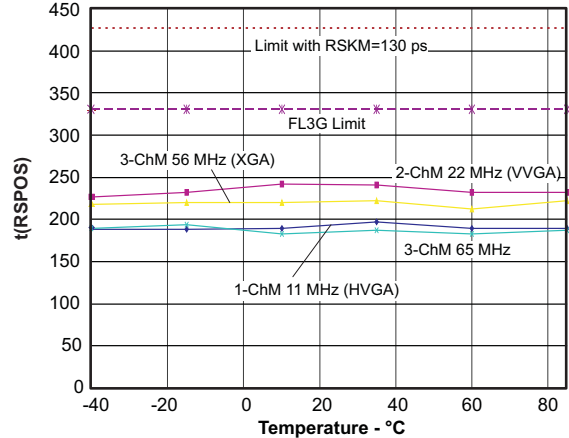

Figure 23.

TYPICAL CHARACTERISTIC CURVES (continued)

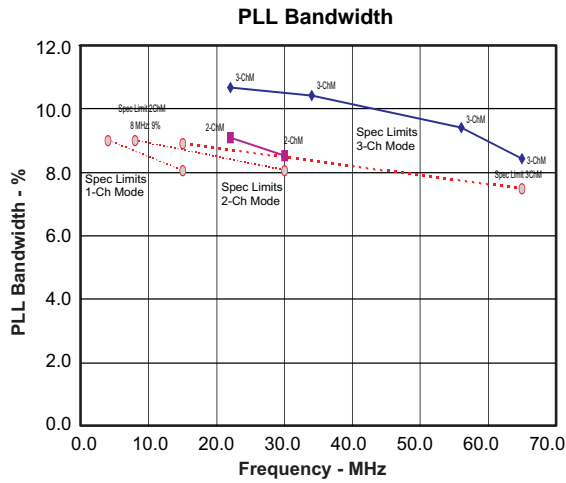

Figure 24.

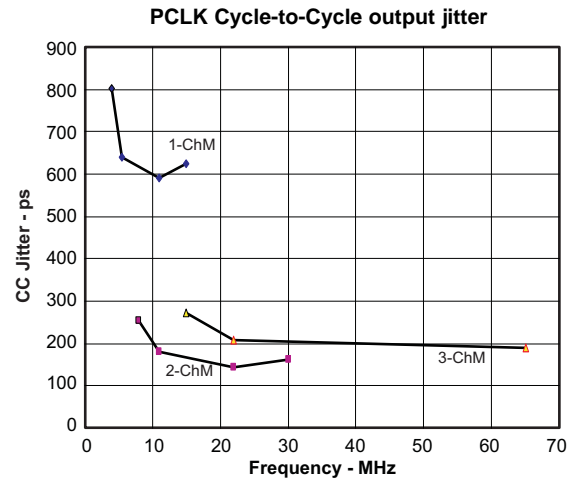

Figure 25.

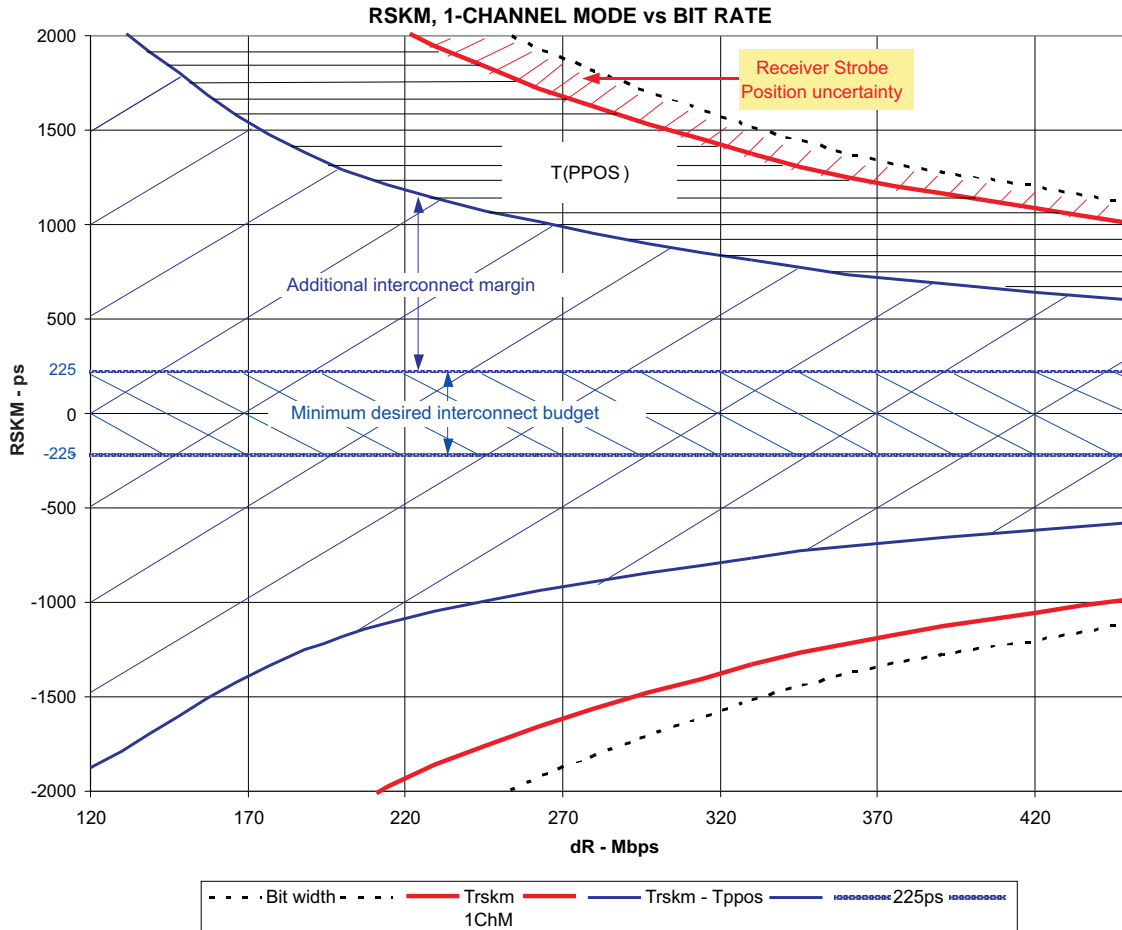

Figure 26.

TYPICAL CHARACTERISTIC CURVES (continued)

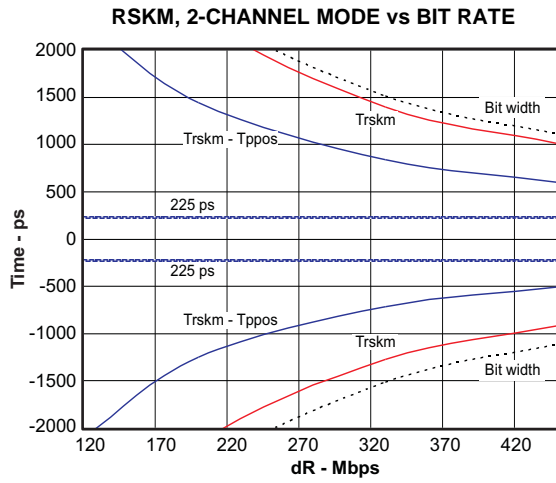

Figure 27.

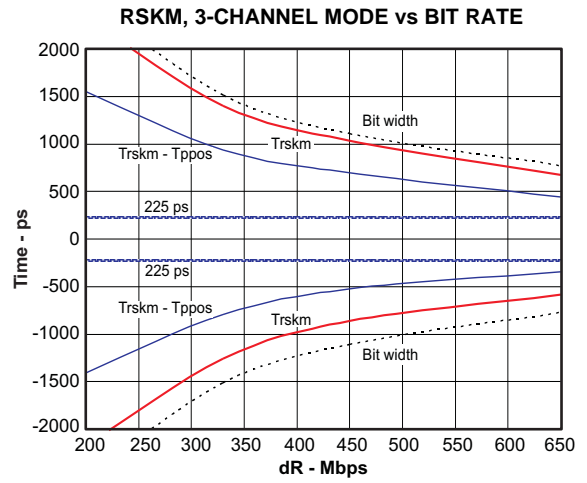

Figure 28.

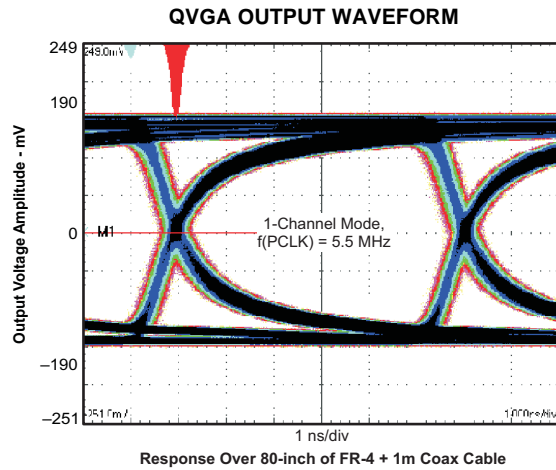

Figure 29.

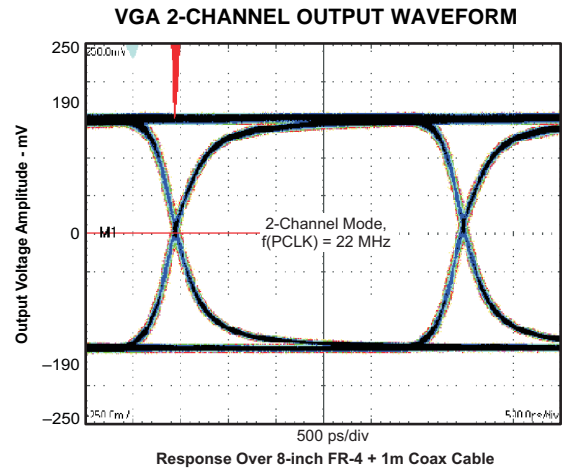

Figure 30.

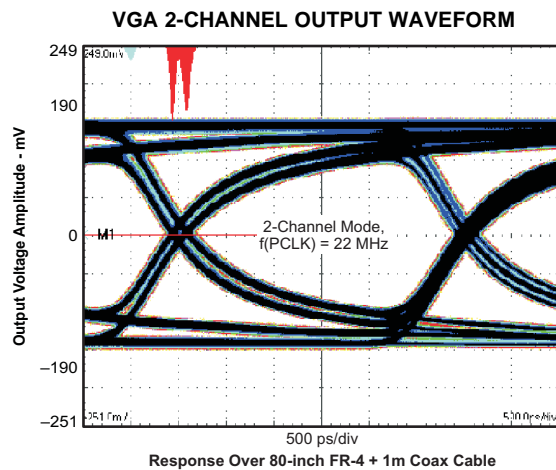

Figure 31.

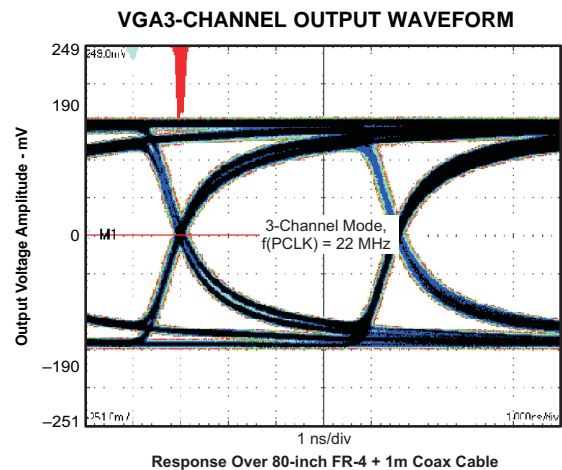

Figure 32.

TYPICAL CHARACTERISTIC CURVES (continued)

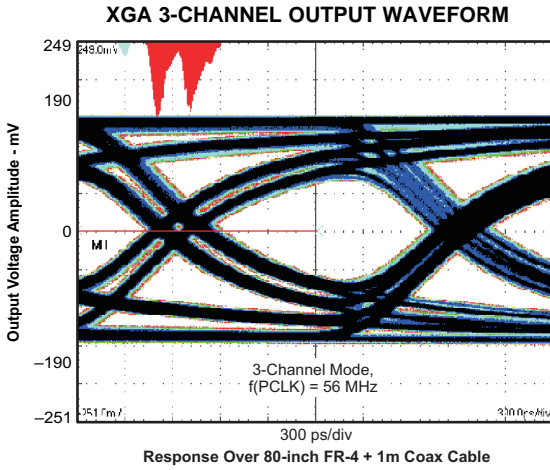

Figure 33.

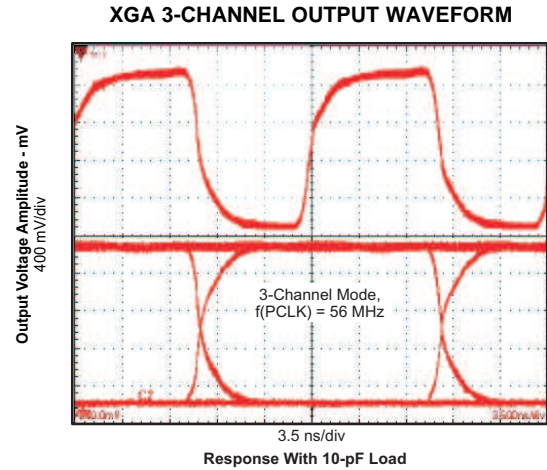

Figure 34.

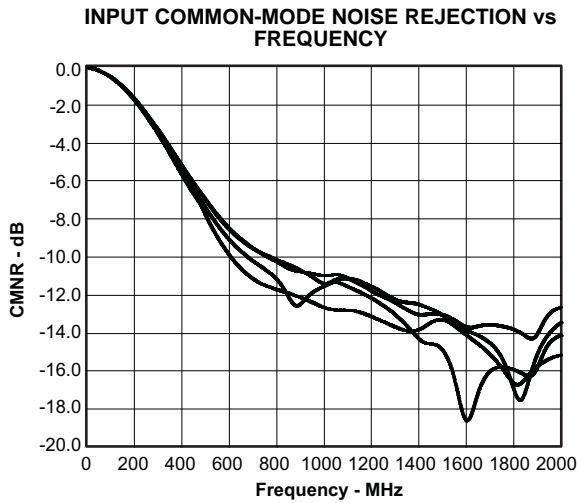

Figure 35.

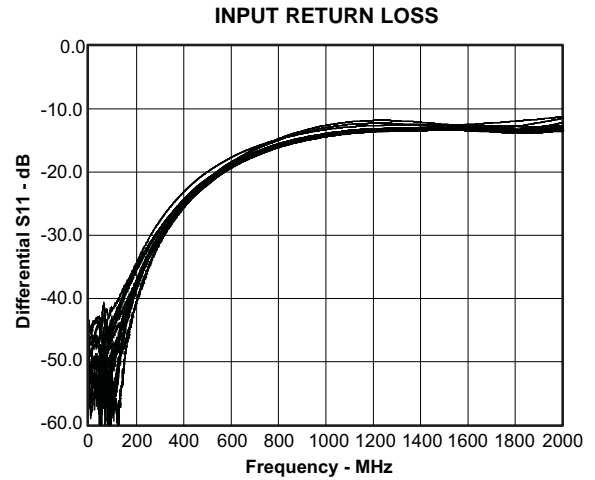

Figure 36.

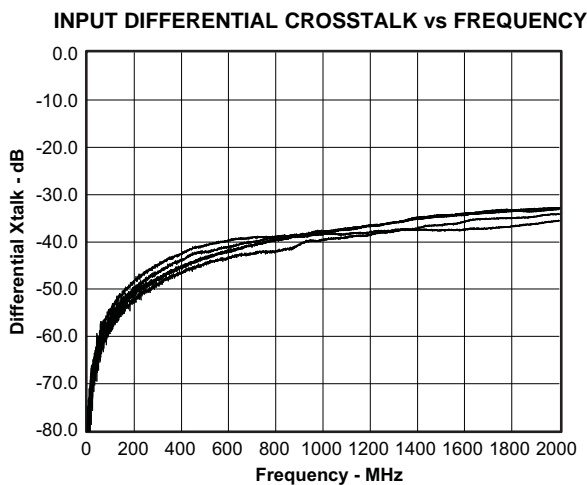

Figure 37.

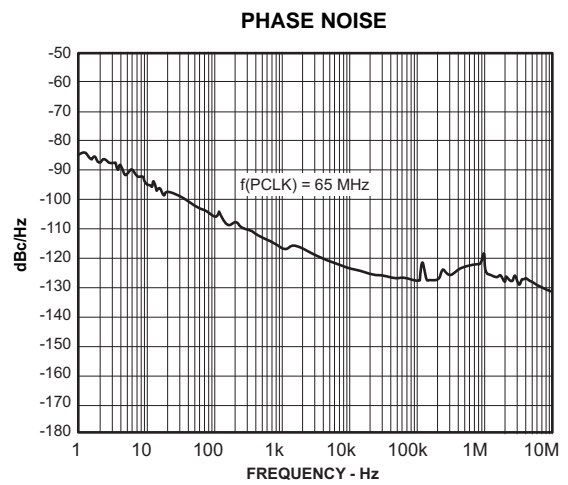

Figure 38.

TYPICAL CHARACTERISTIC CURVES (continued)

GTEM SAE J1752/3 EMI test

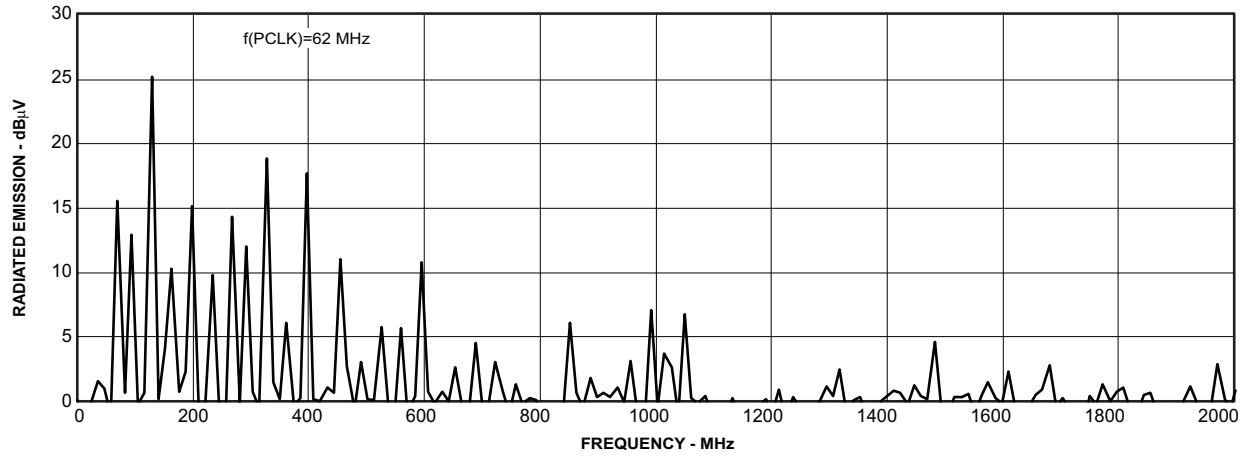

Figure 39.

APPLICATION INFORMATION

Preventing Increased Leakage Currents in Control Inputs

A floating (left open) CMOS input allows leakage currents to flow from V_{DD} to GND. Do not leave any CMOS input unconnected or floating. Every input must be connected to a valid logic level V_{IH} or V_{OL} while power is supplied to V_{DD} . This also minimizes the power consumption of standby and power down mode.

Power Supply Design Recommendation

For a multilayer PCB, it is recommended to keep one common GND layer underneath the device and connect all ground terminals directly to this plane.

SN65LVDS302 DECOUPLING RECOMMENDATION

The SN65LVDS302 was designed to operate reliably in a constricted environment with other digital switching ICs. In cell phone designs, the SN65LVDS302 often shares a power supply with various other ICs. The SN65LVDS302 can operate with power supply noise as specified in Recommend Device Operating Conditions. To minimize the power supply noise floor, provide good decoupling near the SN65LVDS302 power pins. The use of four ceramic capacitors (two 0.01 μF and two 0.1 μF) provides good performance. At the very least, it is recommended to install one 0.1 μF and one 0.01 μF capacitor near the SN65LVDS302. To avoid large current loops and trace inductance, the trace length between decoupling capacitor and IC power inputs pins must be minimized. Placing the capacitor underneath the SN65LVDS302 on the bottom of the PCB is often a good choice.

VGA APPLICATION

Figure 40 shows a possible implementation of a standard 640x480 VGA display. The LVDS301 interfaces to the SN65LVDS302, which is the corresponding receiver device to deserialize the data and drive the display driver. The pixel clock rate of 22 MHz assumes ~10% blanking overhead and 60 Hz display refresh rate. The application assumes 24-bit color resolution. Also shown is how the application processor provides a powerdown (reset) signal for both serializer and the display driver. The signal count over the Flexible Printed Circuit board (FPC) could be further decreased by using the standby option on the SN65LVDS302 and pulling RXEN high with a 30 k Ω resistor to V_{DD} .

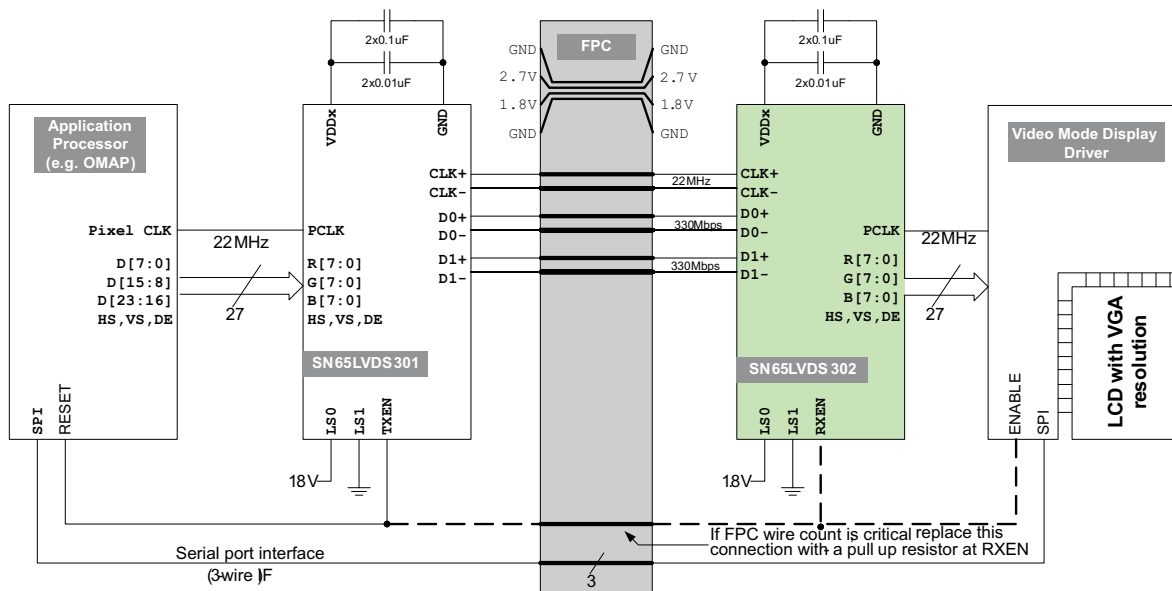

Figure 40. Typical VGA Display Application

APPLICATION INFORMATION (continued)

DUAL LCD-DISPLAY APPLICATION

The example in Figure 41 shows a possible application setup driving two video-mode displays from one application processor. The data rate of 330 Mbps at a pixel clock rate of 5.5 MHz corresponds to a 320x240 QVGA resolution at 60 Hz refresh rate and 10% blanking overhead.

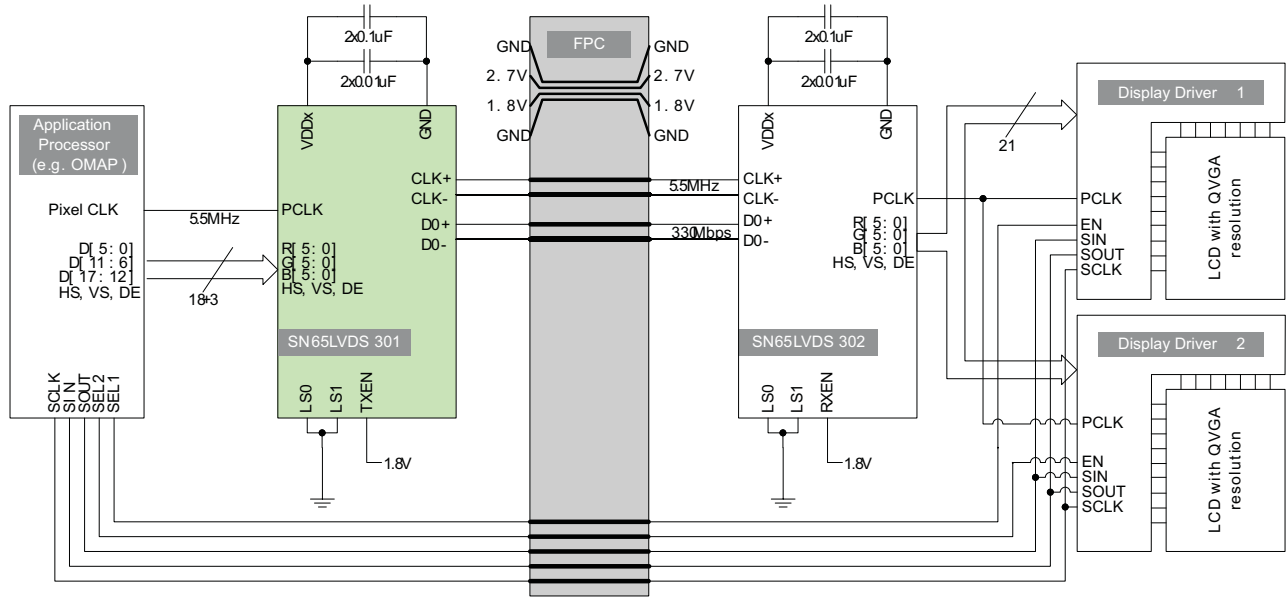

Figure 41. Example Dual-QVGA Display Application

TYPICAL APPLICATION FREQUENCIES

The SN65LVDS302 supports pixel clock frequencies from 4 MHz to 65 MHz over 1, 2, or 3 data lanes. Table 14 provides a few typical display resolution examples and shows the number of data lanes necessary to connect the SN65LVDS302 with the display. The blanking overhead is assumed to be 20%. Often, blanking overhead is smaller, resulting in a lower data rate. Furthermore, the examples in the table assumes a display frame refresh rate of 60-Hz. The actual refresh rate may differ depending on the application-processor clock implementation.

Table 14. Typical Application Data Rates and Serial Lane Usage

Display Screen Resolution	Visible Pixel Count	Blanking Overhead	Display Refresh Rate	Pixel Clock Frequency [MHz]	Serial Data Rate Per Lane		
					1-ChM	2-ChM	3-ChM
176x220 (QCIF+)	38,720	20%	90 Hz	4.2 MHz	125 Mbps		
240x320 (QVGA)	76,800	20%	60 Hz	5.5 MHz	166 Mbps		
640x200	128,000	20%	60 Hz	9.2 MHz	276 Mbps	138 Mbps	
352x416 (CIF+)	146,432	20%	60 Hz	10.5 MHz	316 Mbps	158 Mbps	
352x440	154,880	20%	60 Hz	11.2 MHz	335 Mbps	167 Mbps	
320x480 (HVGA)	153,600	20%	60 Hz	11.1 MHz	332 Mbps	166 Mbps	
800x250	200,000	20%	60 Hz	14.4 MHz	432 Mbps	216 Mbps	
640x320	204,800	20%	60 Hz	14.7 MHz	442 Mbps	221 Mbps	
640x480 (VGA)	307,200	20%	60 Hz	22.1 MHz		332 Mbps	221 Mbps
1024x320	327,680	20%	60 Hz	23.6 MHz		354 Mbps	236 Mbps
854x480 (WVGA)	409,920	20%	60 Hz	29.5 MHz		443 Mbps	295 Mbps
800x600 (SVGA)	480,000	20%	60 Hz	34.6 MHz			346 Mbps
1024x768 (XGA)	786,432	20%	60 Hz	56.6 MHz			566 Mbps

CALCULATION EXAMPLE: HVGA DISPLAY

The following calculation shows an example for a Half-VGA display with the following parameters:

- Display Resolution: 480 x 320
- Frame Refresh Rate: 58.4 Hz
- Horizontal Visible Pixel: 480 columns
- Horizontal Front Porch: 20 columns
- Horizontal Sync: 5 columns
- Horizontal Back Porch: 3 columns
- Vertical Visible Pixel: 320 lines
- Vertical Front Porch: 10 lines
- Vertical Sync: 5 lines
- Vertical Back Porch: 3 lines

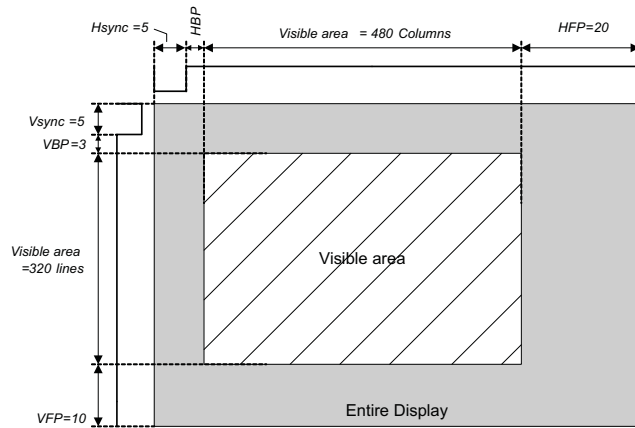

Figure 42. HVGA Display

Calculation of the total number of pixel and blanking overhead:

- Visible Area Pixel Count: $480 \times 320 = 153600$ pixel
- Total Frame Pixel Count: $(480+20+5+3) \times (320+10+5+3) = 171704$ pixel
- Blanking Overhead: $(171704-153600) \div 153600 = 11.8 \%$

The application requires the following serial-link parameters:

- Pixel Clk Frequency: $171704 \times 58.4 \text{ Hz} = 10.0 \text{ MHz}$
- Serial Data Rate:
 - 1-channel mode: $10.0 \text{ MHz} \times 30 \text{ bit/channel} = 300 \text{ Mbps}$
 - 2-channel mode: $10.0 \text{ MHz} \times 15 \text{ bit/channel} = 150 \text{ Mbps}$

How To Determine Interconnect Skew and Jitter Budget

Designing a reliable data link requires examining the interconnect skew and jitter budget. The sum of all transmitter, PCB, connector, FPC, and receiver uncertainties must be smaller than the available serial bit time. The highest pixel clock frequency defines the available serial bit time. The transmitter timing uncertainty is defined by t_{PPOS} in the transmitter data sheet. For a bit-error-rate target of $\leq 10^{-12}$, the measurement duration for t_{PPOS} is ≥ 1012 . The SN65LVDS302 receiver can tolerate a maximum timing uncertainty defined by t_{RSKM} . The interconnect budget is calculated by:

$$t_{interconnect} = t_{RSKM} - t_{PPOS} \tag{1}$$

Example:

$f_{PCLK(max)} = 23 \text{ MHz}$ (VGA display resolution, 60 Hz)

Transmission mode: 2-ChM; $t_{PPOS}(SN65LVDS301) = 330 \text{ ps}$

Target bit error rate: 10^{-12}

$t_{RSKM}(SN65LVDS302) = 1/(2 \cdot 15 \cdot f_{PCLK}) - 480 \text{ ps} = 969 \text{ ps}$

The interconnect budget for cable skew & ISI needs to be smaller than:

$$t_{interconnect} = t_{RSKM} - t_{PPOS} = 639\text{ps} \tag{2}$$

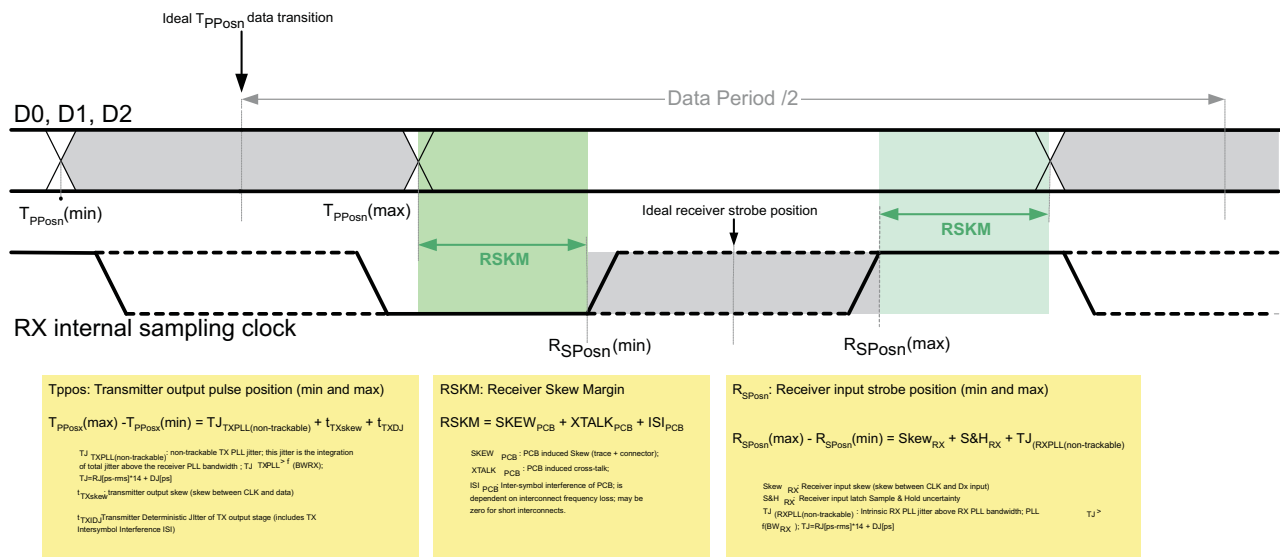

Figure 43. Jitter Budget

F/S-PIN SETTING AND CONNECTING THE SN65LVDS302 TO AN LCD DRIVER

NOTE:

Receiver PLL tracking: To maximize the design margin for the interconnect, good RX PLL tracking of the TX PLL is important. FlatLink3G requires the RX PLL to have a bandwidth higher than the bandwidth of the TX PLL. The SN65LVDS302 PLL design is optimized to track the SN65LVDS0301 PLL particularly well, thus providing a very large receiver skew margin. A FlatLink3G-compliant link must provide at least ± 225 ppm of receiver skew margin for the interconnect.

It is important to understand the tradeoff between power consumption, EMI, and maximum speed when selecting the F/S signal. It is beneficial to choose the slowest rise time possible to minimize EMI and power consumption. Unfortunately a slower rise time also reduces the timing margin left for the LCD driver. Hence it is necessary to calculate the timing margin to select the correct F/S pin setting.

The output rise time depends on the output driver strength and the output load. An LCD driver typical capacitive load is assumed with ~ 10 pF. The higher the capacitive load, the slower will be the rise time. Rise time of the SN65LVDS302 is measured as the time duration it takes the output voltage to rise from 20% of V_{DD} and 80% of V_{DD} and fall time is defined as the time for the output voltage to transition from 80% of V_{DD} down to 20%.

Within one mode of operation and one F/S pin setting, the rise time of the output stage is fixed and does not adjust to the pixel frequency. Due to the short bit time at very fast pixel clock speeds and the real capacitive load of the display driver, the output amplitude might not reach V_{DD} and GND saturation fully. To ensure sufficient signal swing and verify the design margin, it becomes necessary to determine that the output amplitude under any circumstance reaches the display driver's input stage logic threshold (usually 30% and 70% of V_{DD}).

Figure 44 shows a worst-case rise time simulation assuming a LCD driver load of 16 pF at VGA display resolution. PCLK is the fastest switching output. With F/S set to GND (Figure 44-a), the PCLK output voltage amplitude is significantly reduced. The voltage amplitude of the output data RGB[7:0], VS, HS, and DE shows less amplitude attenuation because these outputs carry random data pattern and toggle equal or less than half of the PCLK frequency. It is necessary to determine the timing margin between the LVDS302 output and LCD driver input.

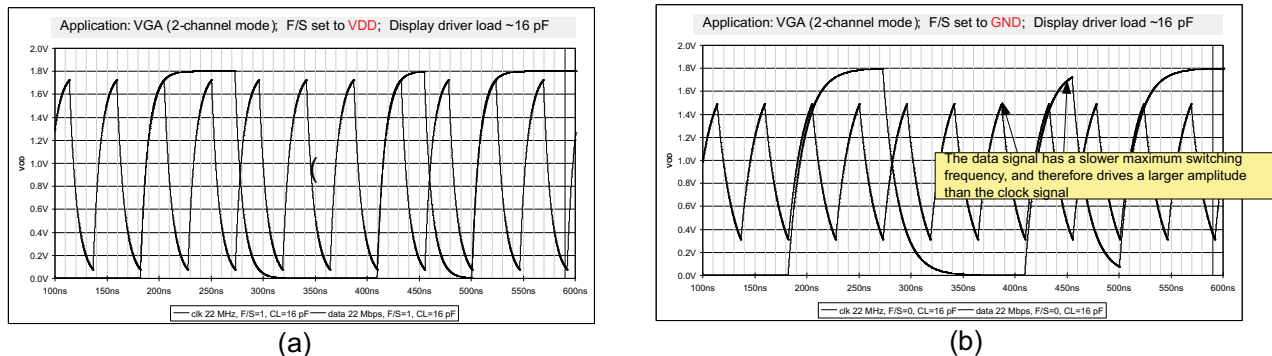

Figure 44. Output Amplitude as a Function of Output Toggling Frequency, Capacitive Load and F/S Setting

HOW TO DETERMINE THE LCD DRIVER TIMING MARGIN

To determine the timing margin, it is necessary to specify the frequency of operation, identify the set-up and hold time of the LCD driver, and specify the output load of the SN65LVDS302 as a combination of the LCD driver input parasitics plus any capacitance caused by the connecting PCB trace. Furthermore, the setting of pin F/S and the SN65LVDS302 output skew impact the margin. The total remaining design margin calculates as following:

$$t_{DM} = \frac{1}{2 \times f_{PCLK}} - t_{DUTP(max_error)} - \frac{t_{rise(max)} \times C_{LOAD}}{10 \text{ pF}} - |t_{OSK}| \quad (3)$$

where:

t_{DM} – Design margin

f_{PCLK} – Pixel clock frequency

$t_{DUTP(max_error)}$ – maximum duty cycle error

$t_{rise(max)}$ – maximum rise or fall time; see $t_{R/F}$ under switching characteristics

C_L – parasitic capacitance (sum of LCD driver input parasitics + connecting PCB trace)

t_{skew} – clock to data output skew SN65LVDS302

Example:

At a pixel clock frequency of 5.5MHz (QVGA), and an assumed LCD driver load of 15 pF, the remaining timing margin is:

$$t_{DUTP(max_error)} = \frac{|t_{DUTP(max)} - 50|}{100\%} \times t_{PCLK} = \frac{5\%}{100\%} \times \frac{1}{5.5\text{MHz}} = 9.1\text{ns}$$

$$t_{DM} = \frac{1}{2 \times 5.5\text{MHz}} - 9\text{ns} - \frac{16\text{ns}_{(F/S=GND)} \times 15\text{pF}}{10\text{pF}} - 500\text{ps} = 57.3\text{ns}$$

As long as the set-up and hold time of the LCD driver are each less than 57 ns, the timing budget is met sufficiently.

PACKAGING INFORMATION

Orderable Device	Status ⁽¹⁾	Package Type	Package Drawing	Pins	Package Qty	Eco Plan ⁽²⁾	Lead/Ball Finish	MSL Peak Temp ⁽³⁾
SN65LVDS302ZQE	ACTIVE	BGA MI CROSTA R JUNI OR	ZQE	80	360	Green (RoHS & no Sb/Br)	SNAGCU	Level-3-260C-168 HR
SN65LVDS302ZQER	ACTIVE	BGA MI CROSTA R JUNI OR	ZQE	80	2500	Green (RoHS & no Sb/Br)	SNAGCU	Level-3-260C-168 HR

⁽¹⁾ The marketing status values are defined as follows:

ACTIVE: Product device recommended for new designs.

LIFEBUY: TI has announced that the device will be discontinued, and a lifetime-buy period is in effect.

NRND: Not recommended for new designs. Device is in production to support existing customers, but TI does not recommend using this part in a new design.

PREVIEW: Device has been announced but is not in production. Samples may or may not be available.

OBSOLETE: TI has discontinued the production of the device.

⁽²⁾ Eco Plan - The planned eco-friendly classification: Pb-Free (RoHS), Pb-Free (RoHS Exempt), or Green (RoHS & no Sb/Br) - please check <http://www.ti.com/productcontent> for the latest availability information and additional product content details.

TBD: The Pb-Free/Green conversion plan has not been defined.

Pb-Free (RoHS): TI's terms "Lead-Free" or "Pb-Free" mean semiconductor products that are compatible with the current RoHS requirements for all 6 substances, including the requirement that lead not exceed 0.1% by weight in homogeneous materials. Where designed to be soldered at high temperatures, TI Pb-Free products are suitable for use in specified lead-free processes.

Pb-Free (RoHS Exempt): This component has a RoHS exemption for either 1) lead-based flip-chip solder bumps used between the die and package, or 2) lead-based die adhesive used between the die and leadframe. The component is otherwise considered Pb-Free (RoHS compatible) as defined above.

Green (RoHS & no Sb/Br): TI defines "Green" to mean Pb-Free (RoHS compatible), and free of Bromine (Br) and Antimony (Sb) based flame retardants (Br or Sb do not exceed 0.1% by weight in homogeneous material)

⁽³⁾ MSL, Peak Temp. -- The Moisture Sensitivity Level rating according to the JEDEC industry standard classifications, and peak solder temperature.

Important Information and Disclaimer:The information provided on this page represents TI's knowledge and belief as of the date that it is provided. TI bases its knowledge and belief on information provided by third parties, and makes no representation or warranty as to the accuracy of such information. Efforts are underway to better integrate information from third parties. TI has taken and continues to take reasonable steps to provide representative and accurate information but may not have conducted destructive testing or chemical analysis on incoming materials and chemicals. TI and TI suppliers consider certain information to be proprietary, and thus CAS numbers and other limited information may not be available for release.

In no event shall TI's liability arising out of such information exceed the total purchase price of the TI part(s) at issue in this document sold by TI to Customer on an annual basis.

TAPE AND REEL INFORMATION



QUADRANT ASSIGNMENTS FOR PIN 1 ORIENTATION IN TAPE



*All dimensions are nominal

Device	Package Type	Package Drawing	Pins	SPQ	Reel Diameter (mm)	Reel Width W1 (mm)	A0 (mm)	B0 (mm)	K0 (mm)	P1 (mm)	W (mm)	Pin1 Quadrant
SN65LVDS302ZQER	BGA MICROSTAR JUNIOR	ZQE	80	2500	330.0	12.4	5.3	5.3	1.5	8.0	12.0	Q1

TAPE AND REEL BOX DIMENSIONS



*All dimensions are nominal

Device	Package Type	Package Drawing	Pins	SPQ	Length (mm)	Width (mm)	Height (mm)
SN65LVDS302ZQER	BGA MICROSTAR JUNIOR	ZQE	80	2500	340.5	333.0	20.6

ZQE (S-PBGA-N80)

PLASTIC BALL GRID ARRAY

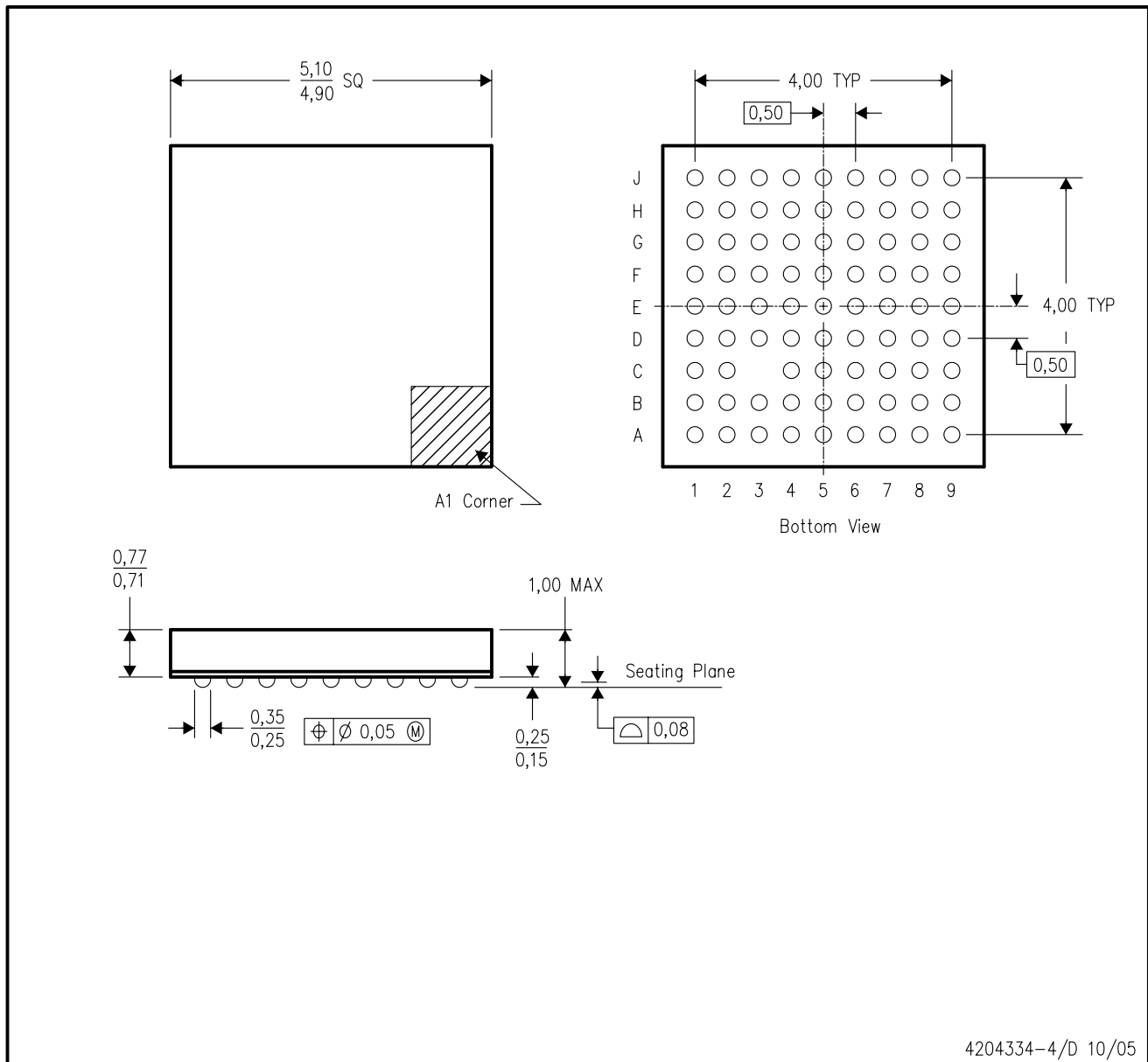

- NOTES:
- A. All linear dimensions are in millimeters.
 - B. This drawing is subject to change without notice.
 - C. Falls within JEDEC MO-225
 - D. This is a lead-free solder ball design.

IMPORTANT NOTICE

Texas Instruments Incorporated and its subsidiaries (TI) reserve the right to make corrections, modifications, enhancements, improvements, and other changes to its products and services at any time and to discontinue any product or service without notice. Customers should obtain the latest relevant information before placing orders and should verify that such information is current and complete. All products are sold subject to TI's terms and conditions of sale supplied at the time of order acknowledgment.

TI warrants performance of its hardware products to the specifications applicable at the time of sale in accordance with TI's standard warranty. Testing and other quality control techniques are used to the extent TI deems necessary to support this warranty. Except where mandated by government requirements, testing of all parameters of each product is not necessarily performed.

TI assumes no liability for applications assistance or customer product design. Customers are responsible for their products and applications using TI components. To minimize the risks associated with customer products and applications, customers should provide adequate design and operating safeguards.

TI does not warrant or represent that any license, either express or implied, is granted under any TI patent right, copyright, mask work right, or other TI intellectual property right relating to any combination, machine, or process in which TI products or services are used. Information published by TI regarding third-party products or services does not constitute a license from TI to use such products or services or a warranty or endorsement thereof. Use of such information may require a license from a third party under the patents or other intellectual property of the third party, or a license from TI under the patents or other intellectual property of TI.

Reproduction of TI information in TI data books or data sheets is permissible only if reproduction is without alteration and is accompanied by all associated warranties, conditions, limitations, and notices. Reproduction of this information with alteration is an unfair and deceptive business practice. TI is not responsible or liable for such altered documentation. Information of third parties may be subject to additional restrictions.

Resale of TI products or services with statements different from or beyond the parameters stated by TI for that product or service voids all express and any implied warranties for the associated TI product or service and is an unfair and deceptive business practice. TI is not responsible or liable for any such statements.

TI products are not authorized for use in safety-critical applications (such as life support) where a failure of the TI product would reasonably be expected to cause severe personal injury or death, unless officers of the parties have executed an agreement specifically governing such use. Buyers represent that they have all necessary expertise in the safety and regulatory ramifications of their applications, and acknowledge and agree that they are solely responsible for all legal, regulatory and safety-related requirements concerning their products and any use of TI products in such safety-critical applications, notwithstanding any applications-related information or support that may be provided by TI. Further, Buyers must fully indemnify TI and its representatives against any damages arising out of the use of TI products in such safety-critical applications.

TI products are neither designed nor intended for use in military/aerospace applications or environments unless the TI products are specifically designated by TI as military-grade or "enhanced plastic." Only products designated by TI as military-grade meet military specifications. Buyers acknowledge and agree that any such use of TI products which TI has not designated as military-grade is solely at the Buyer's risk, and that they are solely responsible for compliance with all legal and regulatory requirements in connection with such use.

TI products are neither designed nor intended for use in automotive applications or environments unless the specific TI products are designated by TI as compliant with ISO/TS 16949 requirements. Buyers acknowledge and agree that, if they use any non-designated products in automotive applications, TI will not be responsible for any failure to meet such requirements.

Following are URLs where you can obtain information on other Texas Instruments products and application solutions:

Products

Amplifiers	amplifier.ti.com
Data Converters	dataconverter.ti.com
DSP	dsp.ti.com
Clocks and Timers	www.ti.com/clocks
Interface	interface.ti.com
Logic	logic.ti.com
Power Mgmt	power.ti.com
Microcontrollers	microcontroller.ti.com
RFID	www.ti-rfid.com
RF/IF and ZigBee® Solutions	www.ti.com/lprf

Applications

Audio	www.ti.com/audio
Automotive	www.ti.com/automotive
Broadband	www.ti.com/broadband
Digital Control	www.ti.com/digitalcontrol
Medical	www.ti.com/medical
Military	www.ti.com/military
Optical Networking	www.ti.com/opticalnetwork
Security	www.ti.com/security
Telephony	www.ti.com/telephony
Video & Imaging	www.ti.com/video
Wireless	www.ti.com/wireless

Mailing Address: Texas Instruments, Post Office Box 655303, Dallas, Texas 75265
Copyright © 2008, Texas Instruments Incorporated