

# SN75LP1185 LOW-POWER MULTIPLE RS-232 DRIVERS AND RECEIVERS

SLLS335A – JANUARY 1999 – REVISED JANUARY 2001

- **Single-Chip TIA/EIA-232-F Interface for IBM™ PC/AT™ Serial Port**
- **Designed to Transmit and Receive 4- $\mu$ s Pulses (Equivalent to 256 kbit/s)**
- **Less Than 21-mW Power Consumption**
- **Wide Supply-Voltage Range . . . 4.75 V to 15 V**
- **Driver Output Slew Rates Are Internally Controlled to 30 V/ $\mu$ s Max**
- **Receiver Input Hysteresis . . . 1000 mV Typical**
- **TIA/EIA-232-F Bus-Pin ESD Protection Exceeds:**
  - 15-kV, Human-Body Model
- **Three Drivers and Five Receivers Meet or Exceed the Requirements of TIA/EIA-232-F and ITU V.28**
- **Complements the SN75LP196**
- **Designed to Replace the Industry-Standard SN75185 and SN75C185 With the Same Flow-Through Pinout**
- **Package Options Include Plastic Small-Outline (DW), Shrink Small-Outline (DB), and Dual-In-Line (N) Packages**

DB, DW, OR N PACKAGE  
(TOP VIEW)

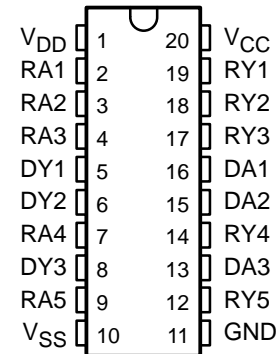

## description

The SN75LP1185 is a low-power bipolar device containing three drivers and five receivers, with 15 kV of ESD protection on the bus pins with respect to each other. Bus pins are defined as those pins that tie directly to the serial-port connector, including GND. The pinout matches the flow-through design of the industry-standard SN75185 and SN75C185. The flow-through pinout of the SN75LP1185 allows easy interconnection of the UART and serial-port connector of the IBM PC/AT and compatibles. The SN75LP1185 provides a rugged, low-cost solution for this function with the combination of the bipolar processing and 15 kV of ESD protection.

The SN75LP1185 has internal slew-rate control to provide a maximum rate of change in the output signal of 30 V/ $\mu$ s. The driver output swing is nominally clamped at  $\pm 6$  V to enable the higher data rates associated with this device and to reduce EMI emissions. Even though the driver outputs are clamped, they can handle voltages up to  $\pm 15$  V without damage. All the logic inputs can accept 3.3-V or 5-V input signals.

The SN75LP1185 complies with the requirements of TIA/EIA-232-F and ITU V.28. These standards are for data interchange between a host computer and peripheral at signaling rates up to 20 kbit/s. The switching speeds of the SN75LP1185 support rates up to 256 kbit/s.

The SN75LP1185 is characterized for operation from 0°C to 70°C.



Please be aware that an important notice concerning availability, standard warranty, and use in critical applications of Texas Instruments semiconductor products and disclaimers thereto appears at the end of this data sheet.

IBM and PC/AT are trademarks of International Business Machines Corporation.

PRODUCTION DATA information is current as of publication date. Products conform to specifications per the terms of Texas Instruments standard warranty. Production processing does not necessarily include testing of all parameters.

 **TEXAS  
INSTRUMENTS**

POST OFFICE BOX 655303 • DALLAS, TEXAS 75265

Copyright © 2001, Texas Instruments Incorporated

# SN75LP1185 LOW-POWER MULTIPLE RS-232 DRIVERS AND RECEIVERS

SLLS335A – JANUARY 1999 – REVISED JANUARY 2001

## AVAILABLE OPTIONS

T <sub>A</sub>	PACKAGED DEVICES		
	PLASTIC SHRINK SMALL-OUTLINE (DB)	PLASTIC SMALL OUTLINE (DW)	PLASTIC DIP (N)
0°C to 70°C	SN75LP1185DBR	SN75LP1185DW	SN75LP1185N

The DB package is only available taped and reeled. The DW package also is available taped and reeled. Add the suffix R to device type (e.g., SN75LP1185DWR).

## Function Tables

### DRIVER

INPUT DA	OUTPUT DY
H	L
L	H
Open	L

### RECEIVER

INPUT RA	OUTPUT RY
H	L
L	H
Open	H

## logic diagram (positive logic)

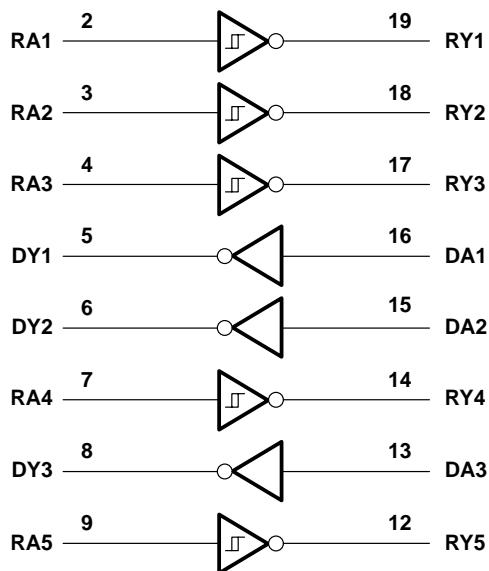

# SN75LP1185

## LOW-POWER MULTIPLE RS-232 DRIVERS AND RECEIVERS

SLLS335A – JANUARY 1999 – REVISED JANUARY 2001

### absolute maximum ratings over operating free-air temperature range (unless otherwise noted)†

Positive supply-voltage range (see Note 1): $V_{CC}$ .....	–0.5 V to 7 V
$V_{DD}$ .....	–0.5 V to 15 V
Negative supply-voltage range, $V_{SS}$ (see Note 1) .....	0.5 V to –15 V
Input-voltage range, $V_I$ : Receiver (RA) .....	–30 V to 30 V
Driver (DA) .....	–0.5 V to $V_{CC} + 0.4$ V
Output-voltage range, $V_O$ : Receiver (RY) .....	–0.5 V to 6 V
Driver (DY) .....	–15 V to 15 V
Electrostatic discharge: Bus pins (human-body model) (see Note 2) .....	Class 3: 15 kV
Bus pins (machine model) .....	500 V
All pins (human-body model) (see Note 2) .....	Class 3: 5 kV
All pins (machine model) .....	400 V
Package thermal impedance, $\theta_{JA}$ (see Note 3): DB package .....	70°C/W
DW package .....	58°C/W
N package .....	69°C/W
Lead temperature 1,6 mm (1/16 inch) from case for 10 seconds .....	260°C
Storage temperature range, $T_{stg}$ .....	65°C to 150°C

† Stresses beyond those listed under “absolute maximum ratings” may cause permanent damage to the device. These are stress ratings only, and functional operation of the device at these or any other conditions beyond those indicated under “recommended operating conditions” is not implied. Exposure to absolute-maximum-rated conditions for extended periods may affect device reliability.

- NOTES: 1. All voltage values are with respect to network ground terminal, unless otherwise noted.  
 2. Per MIL-STD-883, Method 3015.7  
 3. The package thermal impedance is calculated in accordance with JESD 51-7.

### recommended operating conditions

		MIN	NOM	MAX	UNIT
$V_{CC}$	Supply voltage (see Note 4)	4.75	5	5.25	V
$V_{DD}$	Supply voltage (see Note 5)	9	12	15	V
$V_{SS}$	Supply voltage (see Note 5)	–9	–12	–15	V
$V_{IH}$	High-level input voltage		2		V
$V_{IL}$	Low-level input voltage			0.8	V
$V_I$	Receiver input voltage		–25	25	V
$I_{OH}$	High-level output current			–1	mA
$I_{OL}$	Low-level output current			2	mA
$T_A$	Operating free-air temperature		0	70	°C

- NOTES: 4.  $V_{CC}$  cannot be greater than  $V_{DD}$ .  
 5. The device operates down to  $V_{DD} = V_{CC}$  and  $|V_{SS}| = V_{CC}$ , but supply currents increase and other parameters may vary slightly from the data sheet limits.



# SN75LP1185

## LOW-POWER MULTIPLE RS-232 DRIVERS AND RECEIVERS

SLLS335A – JANUARY 1999 – REVISED JANUARY 2001

### supply currents over the recommended operating conditions (unless otherwise noted)

PARAMETER	TEST CONDITIONS	MIN	TYP	MAX	UNIT
Supply current for $V_{CC}$ , $I_{CC}$	$V_{DD} = 9\text{ V}$ , $V_{SS} = -9\text{ V}$			1000	$\mu\text{A}$
	$V_{DD} = 12\text{ V}$ , $V_{SS} = -12\text{ V}$			1000	
Supply current for $V_{DD}$ , $I_{DD}$	$V_{DD} = 9\text{ V}$ , $V_{SS} = -9\text{ V}$			800	
	$V_{DD} = 12\text{ V}$ , $V_{SS} = -12\text{ V}$			800	
Supply current for $V_{SS}$ , $I_{SS}$	$V_{DD} = 9\text{ V}$ , $V_{SS} = -9\text{ V}$			-625	
	$V_{DD} = 12\text{ V}$ , $V_{SS} = -12\text{ V}$			-625	

No load,  
All inputs at minimum  $V_{OH}$  or  
maximum  $V_{OL}$

### driver electrical characteristics over the recommended operating conditions (unless otherwise noted)

PARAMETER	TEST CONDITIONS	MIN	TYP	MAX	UNIT	
$V_{OH}$ High-level output voltage	$V_{IL} = 0.8\text{ V}$ , $R_L = 3\text{ k}\Omega$ , See Figure 1	$V_{DD} = 9\text{ V}$ , $V_{SS} = -9\text{ V}$	5	5.8	6.6	V
		$V_{DD} = 12\text{ V}$ , $V_{SS} = -12\text{ V}$ , See Note 6	5	5.8	6.6	
$V_{OL}$ Low-level output voltage	$V_{IH} = 2\text{ V}$ , $R_L = 3\text{ k}\Omega$ , See Figure 1	$V_{DD} = 9\text{ V}$ , $V_{SS} = -9\text{ V}$	-5	-5.8	-6.9	V
		$V_{DD} = 12\text{ V}$ , $V_{SS} = -12\text{ V}$ , See Note 6	-5	-5.9	-6.9	
$I_{IH}$ High-level input current	$V_I$ at $V_{CC}$			1	$\mu\text{A}$	
$I_{IL}$ Low-level input current	$V_I$ at GND			-1	$\mu\text{A}$	
$I_{OS(H)}$ Short-circuit high-level output current	$V_O = \text{GND}$ or $V_{SS}$ . See Figure 2 and Note 7		-30	-55	mA	
$I_{OS(L)}$ Short-circuit low-level output current	$V_O = \text{GND}$ or $V_{DD}$ . See Figure 2 and Note 7		30	55	mA	
$r_o$ Output resistance	$V_{DD} = V_{SS} = V_{CC} = 0$ , $V_O = 2\text{ V}$	300			$\Omega$	

- NOTES: 6. Maximum output swing is clamped nominally at  $\pm 6\text{ V}$  to enable the higher data rates associated with this device and to reduce EMI emissions. The driver outputs may slightly exceed the maximum output voltage over the full  $V_{CC}$  and temperature ranges.
7. Not more than one output should be shorted at one time.



# SN75LP1185

## LOW-POWER MULTIPLE RS-232 DRIVERS AND RECEIVERS

SLLS335A – JANUARY 1999 – REVISED JANUARY 2001

### driver switching characteristics over recommended operating free-air temperature range (unless otherwise noted)

PARAMETER		TEST CONDITIONS	MIN	TYP	MAX	UNIT		
$t_{PHL}$	Propagation delay time, high- to low-level output	$R_L = 3\text{ k}\Omega$ to $7\text{ k}\Omega$ , $C_L = 15\text{ pF}$ , See Figure 1	300	800	1600	ns		
$t_{PLH}$	Propagation delay time, low- to high-level output	$R_L = 3\text{ k}\Omega$ to $7\text{ k}\Omega$ , $C_L = 15\text{ pF}$ , See Figure 1	300	800	1600	ns		
$t_{TLH}$	Transition time, low- to high-level output	$V_{CC} = 5\text{ V}$ , $V_{DD} = 12\text{ V}$ , $V_{SS} = -12\text{ V}$ , $R_L = 3\text{ k}\Omega$ to $7\text{ k}\Omega$ , See Figure 1 and Note 9	Using $V_{TR} = 10\%$ -to-90% transition region, Driver speed = 250 kbit/s, $C_L = 15\text{ pF}$ , See Note 8		375	2240	ns	
			Using $V_{TR} = \pm 3\text{ V}$ transition region, Driver speed = 250 kbit/s, $C_L = 15\text{ pF}$		200	1500		
			Using $V_{TR} = \pm 2\text{ V}$ transition region, Driver speed = 250 kbit/s, $C_L = 15\text{ pF}$		133	1000		
			Using $V_{TR} = \pm 3\text{ V}$ transition region, Driver speed = 125 kbit/s, $C_L = 2500\text{ pF}$			2750		
$t_{THL}$	Transition time, high- to low-level output	$V_{CC} = 5\text{ V}$ , $V_{DD} = 12\text{ V}$ , $V_{SS} = -12\text{ V}$ , $R_L = 3\text{ k}\Omega$ to $7\text{ k}\Omega$ , See Figure 1 and Note 9	Using $V_{TR} = 10\%$ -to-90% transition region, Driver speed = 250 kbit/s, $C_L = 15\text{ pF}$ , See Note 8		375	2240	ns	
			Using $V_{TR} = \pm 3\text{ V}$ transition region, Driver speed = 250 kbit/s, $C_L = 15\text{ pF}$		200	1500		
			Using $V_{TR} = \pm 2\text{ V}$ transition region, Driver speed = 250 kbit/s, $C_L = 15\text{ pF}$		133	1000		
			Using $V_{TR} = \pm 3\text{ V}$ transition region, Driver speed = 125 kbit/s, $C_L = 2500\text{ pF}$			2750		
SR	Output slew rate	$V_{CC} = 5\text{ V}$ , $V_{DD} = 12\text{ V}$ , $V_{SS} = -12\text{ V}$	Using $V_{TR} = \pm 3\text{ V}$ transition region, Driver speed = 0 to 250 kbit/s, $C_L = 15\text{ pF}$		4	20	30	V/ $\mu$ s

NOTES: 8. Equivalent to the SN75C185. The SN75LP1185 output-voltage swing is clamped to about 70% of the typical SN75C185 output-voltage swing, and the specified limits reflect the reduced output swing.

9. Maximum output swing is limited to  $\pm 6\text{ V}$  to enable the higher data rates associated with this device and to reduce EMI emissions.

### receiver electrical characteristics over recommended operating free-air temperature range (unless otherwise noted)

PARAMETER		TEST CONDITIONS	MIN	TYP	MAX	UNIT
$V_{IT+}$	Positive-going input threshold voltage	See Figure 3	1.6	2	2.55	V
$V_{IT-}$	Negative-going input threshold voltage	See Figure 3	0.6	1	1.45	V
$V_{HYS}$	Input hysteresis, $V_{IT+} - V_{IT-}$	See Figure 3	600	1000		mV
$V_{OH}$	High-level output voltage	$I_{OH} = -1\text{ mA}$	2.5	3.9		V
$V_{OL}$	Low-level output voltage	$I_{OL} = 2\text{ mA}$		0.33	0.5	V
$I_{IH}$	High-level input current	$V_I = 3\text{ V}$	0.43	0.6	1	mA
		$V_I = 25\text{ V}$	3.6	5.1	8.3	
$I_{IL}$	Low-level input current	$V_I = -3\text{ V}$	-0.43	-0.6	-1	mA
		$V_I = -25\text{ V}$	-3.6	-5.1	-8.3	
$I_{OS(H)}$	Short-circuit high-level output current	$V_O = 0$ , See Figure 5 and Note 7			-20	mA
$I_{OS(L)}$	Short-circuit low-level output current	$V_O = V_{CC}$ , See Figure 5 and Note 7			20	mA
$R_{IN}$	Input resistance	$V_I = \pm 3\text{ V}$ to $\pm 25\text{ V}$	3	5	7	k $\Omega$

NOTE 7: Not more than one output should be shorted at one time.



# SN75LP1185 LOW-POWER MULTIPLE RS-232 DRIVERS AND RECEIVERS

SLLS335A – JANUARY 1999 – REVISED JANUARY 2001

receiver switching characteristics over recommended operating free-air temperature range,  $C_L = 50$  pF (unless otherwise noted) (see Figure 4)

PARAMETER		MIN	TYP	MAX	UNIT
$t_{PHL}$	Propagation delay time, high- to low-level output		400	900	ns
$t_{PLH}$	Propagation delay time, low- to high-level output		400	900	ns
$t_{TLH}$	Transition time, low- to high-level output		200	500	ns
$t_{THL}$	Transition time, high- to low-level output		200	400	ns
$t_{SK(p)}$	Pulse skew $ t_{PLH} - t_{PHL} $		200	425	ns

## PARAMETER MEASUREMENT INFORMATION

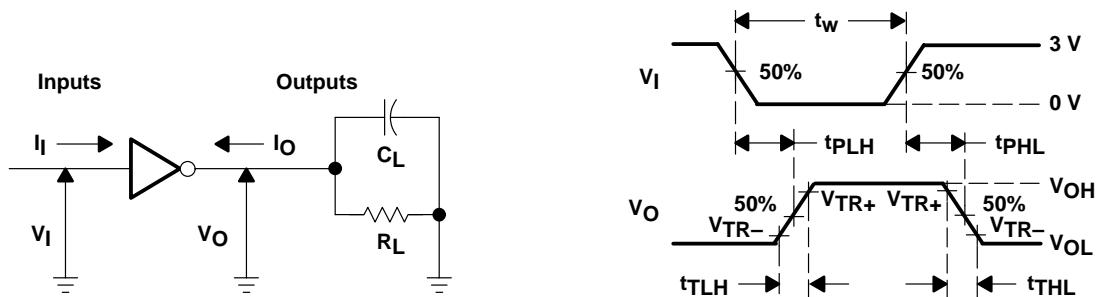

- NOTES: A. The pulse generator has the following characteristics:  
 For  $C_L < 1000$  pF:  $t_w = 4$   $\mu$ s, PRR = 250 kbit/s,  $Z_O = 50$   $\Omega$ ,  $t_r$  and  $t_f < 50$  ns.  
 For  $C_L = 2500$  pF:  $t_w = 8$   $\mu$ s, PRR = 125 kbit/s,  $Z_O = 50$   $\Omega$ ,  $t_r$  and  $t_f < 50$  ns.  
 B.  $C_L$  includes probe and jig capacitance.

Figure 1. Driver Parameter Test Circuit and Waveform

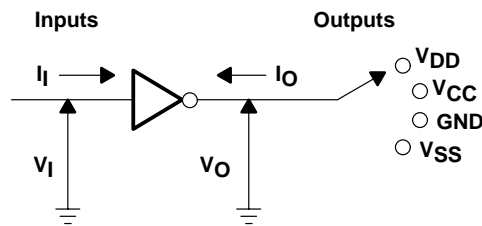

Figure 2. Driver  $I_{OS}$  Test

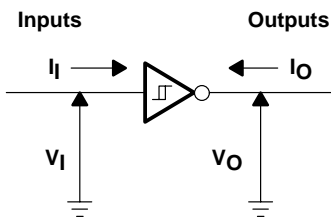
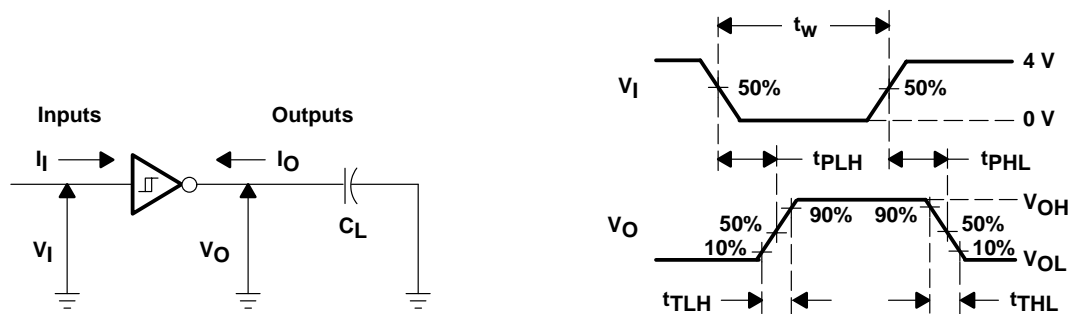

Figure 3. Receiver  $V_{IT}$  Test

**PARAMETER MEASUREMENT INFORMATION**



NOTES: A. The pulse generator has the following characteristics:  $t_w = 4 \mu s$ , PRR = 250 kbit/s,  $Z_O = 50 \Omega$ ,  $t_r$  and  $t_f < 50 ns$ .  
B.  $C_L$  includes probe and jig capacitance.

**Figure 4. Receiver Parameter Test Circuit and Waveform**

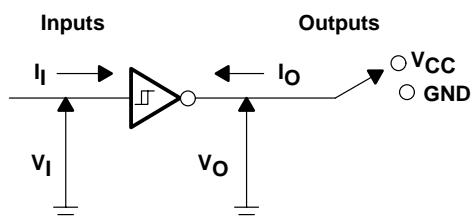

**Figure 5. Receiver  $I_{OS}$  Test**

**APPLICATION INFORMATION**

Diodes placed in series with the  $V_{DD}$  and  $V_{SS}$  leads protect the SN75LP1185 in the fault condition when the device outputs are shorted to  $\pm 15 V$  and the power supplies are at low voltage and provide low-impedance paths to ground (see Figure 6).

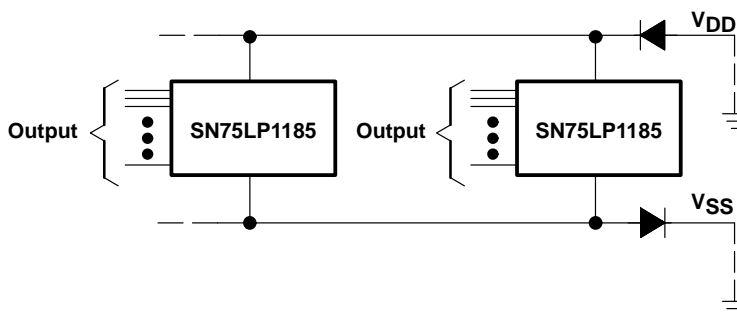

**Figure 6. Power-Supply Protection to Meet Power-Off Fault Conditions of TIA/EIA-232-F**

**PACKAGING INFORMATION**

Orderable Device	Status <sup>(1)</sup>	Package Type	Package Drawing	Pins	Package Qty	Eco Plan <sup>(2)</sup>	Lead/Ball Finish	MSL Peak Temp <sup>(3)</sup>
SN75LP1185DBR	ACTIVE	SSOP	DB	20	2000	Green (RoHS & no Sb/Br)	CU NIPDAU	Level-1-260C-UNLIM
SN75LP1185DBRE4	ACTIVE	SSOP	DB	20	2000	Green (RoHS & no Sb/Br)	CU NIPDAU	Level-1-260C-UNLIM
SN75LP1185DBRG4	ACTIVE	SSOP	DB	20	2000	Green (RoHS & no Sb/Br)	CU NIPDAU	Level-1-260C-UNLIM
SN75LP1185DW	ACTIVE	SOIC	DW	20	25	Green (RoHS & no Sb/Br)	CU NIPDAU	Level-1-260C-UNLIM
SN75LP1185DWE4	ACTIVE	SOIC	DW	20	25	Green (RoHS & no Sb/Br)	CU NIPDAU	Level-1-260C-UNLIM
SN75LP1185DWG4	ACTIVE	SOIC	DW	20	25	Green (RoHS & no Sb/Br)	CU NIPDAU	Level-1-260C-UNLIM
SN75LP1185DWR	ACTIVE	SOIC	DW	20	2000	Green (RoHS & no Sb/Br)	CU NIPDAU	Level-1-260C-UNLIM
SN75LP1185DWRE4	ACTIVE	SOIC	DW	20	2000	Green (RoHS & no Sb/Br)	CU NIPDAU	Level-1-260C-UNLIM
SN75LP1185DWRG4	ACTIVE	SOIC	DW	20	2000	Green (RoHS & no Sb/Br)	CU NIPDAU	Level-1-260C-UNLIM
SN75LP1185N	ACTIVE	PDIP	N	20	20	Pb-Free (RoHS)	CU NIPDAU	N / A for Pkg Type
SN75LP1185NE4	ACTIVE	PDIP	N	20	20	Pb-Free (RoHS)	CU NIPDAU	N / A for Pkg Type
SN75LP1185PWR	OBSOLETE	TSSOP	PW	20		Green (RoHS & no Sb/Br)	CU NIPDAU	Level-1-260C-UNLIM

<sup>(1)</sup> The marketing status values are defined as follows:

**ACTIVE:** Product device recommended for new designs.

**LIFEBUY:** TI has announced that the device will be discontinued, and a lifetime-buy period is in effect.

**NRND:** Not recommended for new designs. Device is in production to support existing customers, but TI does not recommend using this part in a new design.

**PREVIEW:** Device has been announced but is not in production. Samples may or may not be available.

**OBSOLETE:** TI has discontinued the production of the device.

<sup>(2)</sup> Eco Plan - The planned eco-friendly classification: Pb-Free (RoHS), Pb-Free (RoHS Exempt), or Green (RoHS & no Sb/Br) - please check <http://www.ti.com/productcontent> for the latest availability information and additional product content details.

**TBD:** The Pb-Free/Green conversion plan has not been defined.

**Pb-Free (RoHS):** TI's terms "Lead-Free" or "Pb-Free" mean semiconductor products that are compatible with the current RoHS requirements for all 6 substances, including the requirement that lead not exceed 0.1% by weight in homogeneous materials. Where designed to be soldered at high temperatures, TI Pb-Free products are suitable for use in specified lead-free processes.

**Pb-Free (RoHS Exempt):** This component has a RoHS exemption for either 1) lead-based flip-chip solder bumps used between the die and package, or 2) lead-based die adhesive used between the die and leadframe. The component is otherwise considered Pb-Free (RoHS compatible) as defined above.

**Green (RoHS & no Sb/Br):** TI defines "Green" to mean Pb-Free (RoHS compatible), and free of Bromine (Br) and Antimony (Sb) based flame retardants (Br or Sb do not exceed 0.1% by weight in homogeneous material)

<sup>(3)</sup> MSL, Peak Temp. -- The Moisture Sensitivity Level rating according to the JEDEC industry standard classifications, and peak solder temperature.

**Important Information and Disclaimer:** The information provided on this page represents TI's knowledge and belief as of the date that it is provided. TI bases its knowledge and belief on information provided by third parties, and makes no representation or warranty as to the accuracy of such information. Efforts are underway to better integrate information from third parties. TI has taken and continues to take reasonable steps to provide representative and accurate information but may not have conducted destructive testing or chemical analysis on incoming materials and chemicals. TI and TI suppliers consider certain information to be proprietary, and thus CAS numbers and other limited information may not be available for release.



In no event shall TI's liability arising out of such information exceed the total purchase price of the TI part(s) at issue in this document sold by TI to Customer on an annual basis.

**TAPE AND REEL INFORMATION**



**QUADRANT ASSIGNMENTS FOR PIN 1 ORIENTATION IN TAPE**



\*All dimensions are nominal

Device	Package Type	Package Drawing	Pins	SPQ	Reel Diameter (mm)	Reel Width W1 (mm)	A0 (mm)	B0 (mm)	K0 (mm)	P1 (mm)	W (mm)	Pin1 Quadrant
SN75LP1185DBR	SSOP	DB	20	2000	330.0	16.4	8.2	7.5	2.5	12.0	16.0	Q1
SN75LP1185DWR	SOIC	DW	20	2000	330.0	24.4	10.8	13.0	2.7	12.0	24.0	Q1
SN75LP1185PWR	TSSOP	PW	20	0	330.0	16.4	6.95	7.1	1.6	8.0	16.0	Q1

**TAPE AND REEL BOX DIMENSIONS**



\*All dimensions are nominal

Device	Package Type	Package Drawing	Pins	SPQ	Length (mm)	Width (mm)	Height (mm)
SN75LP1185DBR	SSOP	DB	20	2000	346.0	346.0	33.0
SN75LP1185DWR	SOIC	DW	20	2000	346.0	346.0	41.0
SN75LP1185PWR	TSSOP	PW	20	0	346.0	346.0	33.0

DB (R-PDSO-G\*\*)

PLASTIC SMALL-OUTLINE

28 PINS SHOWN



- NOTES: A. All linear dimensions are in millimeters.  
 B. This drawing is subject to change without notice.  
 C. Body dimensions do not include mold flash or protrusion not to exceed 0,15.  
 D. Falls within JEDEC MO-150

PW (R-PDSO-G\*\*)

PLASTIC SMALL-OUTLINE PACKAGE

14 PINS SHOWN



4040064/F 01/97

- NOTES: A. All linear dimensions are in millimeters.  
 B. This drawing is subject to change without notice.  
 C. Body dimensions do not include mold flash or protrusion not to exceed 0,15.  
 D. Falls within JEDEC MO-153

DW (R-PDSO-G20)

PLASTIC SMALL-OUTLINE PACKAGE



- NOTES:
- A. All linear dimensions are in inches (millimeters).
  - B. This drawing is subject to change without notice.
  - C. Body dimensions do not include mold flash or protrusion not to exceed 0.006 (0,15).
  - D. Falls within JEDEC MS-013 variation AC.

N (R-PDIP-T\*\*)

PLASTIC DUAL-IN-LINE PACKAGE

16 PINS SHOWN



- NOTES:
- A. All linear dimensions are in inches (millimeters).
  - B. This drawing is subject to change without notice.
  - Falls within JEDEC MS-001, except 18 and 20 pin minimum body length (Dim A).
  - The 20 pin end lead shoulder width is a vendor option, either half or full width.

## IMPORTANT NOTICE

Texas Instruments Incorporated and its subsidiaries (TI) reserve the right to make corrections, modifications, enhancements, improvements, and other changes to its products and services at any time and to discontinue any product or service without notice. Customers should obtain the latest relevant information before placing orders and should verify that such information is current and complete. All products are sold subject to TI's terms and conditions of sale supplied at the time of order acknowledgment.

TI warrants performance of its hardware products to the specifications applicable at the time of sale in accordance with TI's standard warranty. Testing and other quality control techniques are used to the extent TI deems necessary to support this warranty. Except where mandated by government requirements, testing of all parameters of each product is not necessarily performed.

TI assumes no liability for applications assistance or customer product design. Customers are responsible for their products and applications using TI components. To minimize the risks associated with customer products and applications, customers should provide adequate design and operating safeguards.

TI does not warrant or represent that any license, either express or implied, is granted under any TI patent right, copyright, mask work right, or other TI intellectual property right relating to any combination, machine, or process in which TI products or services are used. Information published by TI regarding third-party products or services does not constitute a license from TI to use such products or services or a warranty or endorsement thereof. Use of such information may require a license from a third party under the patents or other intellectual property of the third party, or a license from TI under the patents or other intellectual property of TI.

Reproduction of TI information in TI data books or data sheets is permissible only if reproduction is without alteration and is accompanied by all associated warranties, conditions, limitations, and notices. Reproduction of this information with alteration is an unfair and deceptive business practice. TI is not responsible or liable for such altered documentation. Information of third parties may be subject to additional restrictions.

Resale of TI products or services with statements different from or beyond the parameters stated by TI for that product or service voids all express and any implied warranties for the associated TI product or service and is an unfair and deceptive business practice. TI is not responsible or liable for any such statements.

TI products are not authorized for use in safety-critical applications (such as life support) where a failure of the TI product would reasonably be expected to cause severe personal injury or death, unless officers of the parties have executed an agreement specifically governing such use. Buyers represent that they have all necessary expertise in the safety and regulatory ramifications of their applications, and acknowledge and agree that they are solely responsible for all legal, regulatory and safety-related requirements concerning their products and any use of TI products in such safety-critical applications, notwithstanding any applications-related information or support that may be provided by TI. Further, Buyers must fully indemnify TI and its representatives against any damages arising out of the use of TI products in such safety-critical applications.

TI products are neither designed nor intended for use in military/aerospace applications or environments unless the TI products are specifically designated by TI as military-grade or "enhanced plastic." Only products designated by TI as military-grade meet military specifications. Buyers acknowledge and agree that any such use of TI products which TI has not designated as military-grade is solely at the Buyer's risk, and that they are solely responsible for compliance with all legal and regulatory requirements in connection with such use.

TI products are neither designed nor intended for use in automotive applications or environments unless the specific TI products are designated by TI as compliant with ISO/TS 16949 requirements. Buyers acknowledge and agree that, if they use any non-designated products in automotive applications, TI will not be responsible for any failure to meet such requirements.

Following are URLs where you can obtain information on other Texas Instruments products and application solutions:

### Products

Amplifiers	<a href="http://amplifier.ti.com">amplifier.ti.com</a>
Data Converters	<a href="http://dataconverter.ti.com">dataconverter.ti.com</a>
DSP	<a href="http://dsp.ti.com">dsp.ti.com</a>
Clocks and Timers	<a href="http://www.ti.com/clocks">www.ti.com/clocks</a>
Interface	<a href="http://interface.ti.com">interface.ti.com</a>
Logic	<a href="http://logic.ti.com">logic.ti.com</a>
Power Mgmt	<a href="http://power.ti.com">power.ti.com</a>
Microcontrollers	<a href="http://microcontroller.ti.com">microcontroller.ti.com</a>
RFID	<a href="http://www.ti-rfid.com">www.ti-rfid.com</a>
RF/IF and ZigBee® Solutions	<a href="http://www.ti.com/lprf">www.ti.com/lprf</a>

### Applications

Audio	<a href="http://www.ti.com/audio">www.ti.com/audio</a>
Automotive	<a href="http://www.ti.com/automotive">www.ti.com/automotive</a>
Broadband	<a href="http://www.ti.com/broadband">www.ti.com/broadband</a>
Digital Control	<a href="http://www.ti.com/digitalcontrol">www.ti.com/digitalcontrol</a>
Medical	<a href="http://www.ti.com/medical">www.ti.com/medical</a>
Military	<a href="http://www.ti.com/military">www.ti.com/military</a>
Optical Networking	<a href="http://www.ti.com/opticalnetwork">www.ti.com/opticalnetwork</a>
Security	<a href="http://www.ti.com/security">www.ti.com/security</a>
Telephony	<a href="http://www.ti.com/telephony">www.ti.com/telephony</a>
Video & Imaging	<a href="http://www.ti.com/video">www.ti.com/video</a>
Wireless	<a href="http://www.ti.com/wireless">www.ti.com/wireless</a>

Mailing Address: Texas Instruments, Post Office Box 655303, Dallas, Texas 75265  
Copyright © 2008, Texas Instruments Incorporated