

## IEEE STD 1149.1 (JTAG) TAP MASTERS WITH 16-BIT GENERIC HOST INTERFACES

SCAS190E – JUNE 1990 – REVISED JANUARY 1997

- **Members of the Texas Instruments SCOPE™ Family of Testability Products**
- **Compatible With the IEEE Standard 1149.1-1990 (JTAG) Test Access Port and Boundary-Scan Architecture**
- **Control Operation of Up to Six Parallel Target Scan Paths**
- **Accommodate Pipeline Delay to Target of Up to 31 Clock Cycles**
- **Scan Data Up to 2<sup>32</sup> Clock Cycles**
- **Execute Instructions for Up to 2<sup>32</sup> Clock Cycles**
- **Each Device Includes Four Bidirectional Event Pins for Additional Test Capability**
- **Inputs Are TTL-Voltage Compatible**
- **EPIC™ (Enhanced-Performance Implanted CMOS) 1-μm Process**
- **Packaged in 44-Pin Plastic Leaded Chip Carrier (FN), 68-Pin Ceramic Pin Grid Array (GB), and 68-Pin Ceramic Quad Flat Packages (HV)**

### description

The 'ACT8990 test-bus controllers (TBC) are members of the Texas Instruments SCOPE™ testability integrated-circuit family. This family of components supports IEEE Standard 1149.1-1990 (JTAG) boundary scan to facilitate testing of complex circuit-board assemblies. The 'ACT8990 differ from other SCOPE™ integrated circuits. Their function is to control the JTAG serial-test bus rather than being target boundary-scannable devices.

The required signals of the JTAG serial-test bus – test clock (TCK), test mode select (TMS), test data input (TDI), and test data output (TDO) can be connected from the TBC to a target device without additional logic. This is done as a chain of IEEE Standard 1149.1-1990 boundary-scannable components that share the same serial-test bus. The TBC generates TMS and TDI signals for its target(s), receives TDO signals from its target(s), and buffers its test clock input (TCKI) to a test clock output (TCKO) for distribution to its target(s). The TMS, TDI, and TDO signals can be connected to a target directly or via a pipeline, with a retiming delay of up to 31 bits. Since the TBC can be configured to generate up to six separate TMS signals [TMS (5–0)], it can be used to control up to six target scan paths that are connected in parallel (i.e., sharing common TCK, TDI, and TDO signals).

While most operations of the TBC are synchronous to TCKI, a test-off ( $\overline{\text{TOFF}}$ ) input is provided for output control of the target interface, and a test-reset ( $\overline{\text{TRST}}$ ) input is provided for hardware/software reset of the TBC. In addition, four event [EVENT (3–0)] I/Os are provided for asynchronous communication to target device(s). Each event has its own event generation/detection logic, and detected events can be counted by two 16-bit counters.

The TBC operates under the control of a host microprocessor/microcontroller via the 5-bit address bus [ADRS (4–0)] and the 16-bit read/write data bus [DATA (15–0)]. Read ( $\overline{\text{RD}}$ ) and write ( $\overline{\text{WR}}$ ) strobes are implemented such that the critical host-interface timing is independent of the TCKI period. Any one of 24 registers can be addressed for read and/or write operations. In addition to control and status registers, the TBC contains two command registers, a read buffer, and a write buffer. Status of the TBC is transmitted to the host via ready ( $\overline{\text{RDY}}$ ) and interrupt ( $\overline{\text{INT}}$ ) outputs.

Major commands can be issued by the host to cause the TBC to generate the TMS sequences necessary to move the target(s) from any stable test-access-port (TAP) controller state to any other stable TAP state, to execute instructions in the Run-Test/Idle TAP state, or to scan instruction or test data through the target(s). A 32-bit counter can be preset to allow a predetermined number of execution or scan operations.

Serial data that appears at the selected TDI input (TDI1 or TDI0) is transferred into the read buffer, which can be read by the host to obtain up to 16 bits of the serial-data stream. Serial data that is transmitted from the TDO output is written by the host to the write buffer.

Please be aware that an important notice concerning availability, standard warranty, and use in critical applications of Texas Instruments semiconductor products and disclaimers thereto appears at the end of this data sheet.

SCOPE and EPIC are trademarks of Texas Instruments Incorporated.

PRODUCTION DATA information is current as of publication date. Products conform to specifications per the terms of Texas Instruments standard warranty. Production processing does not necessarily include testing of all parameters.



Copyright © 1997, Texas Instruments Incorporated  
On products compliant to MIL-PRF-38535, all parameters are tested unless otherwise noted. On all other products, production processing does not necessarily include testing of all parameters.

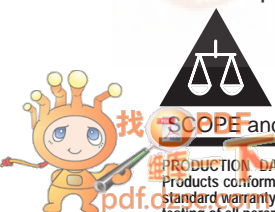

**SN54ACT8990, SN74ACT8990**  
**TEST-BUS CONTROLLERS**  
**IEEE STD 1149.1 (JTAG) TAP MASTERS WITH 16-BIT GENERIC HOST INTERFACES**  
SCAS190E – JUNE 1990 – REVISED JANUARY 1997

**description (continued)**

The SN54ACT8990 is characterized for operation over the full military temperature range of  $-55^{\circ}\text{C}$  to  $125^{\circ}\text{C}$ .  
 The SN74ACT8990 is characterized for operation from  $0^{\circ}\text{C}$  to  $70^{\circ}\text{C}$ .

**SN54ACT8990 . . . HV PACKAGE**  
**(TOP VIEW)**

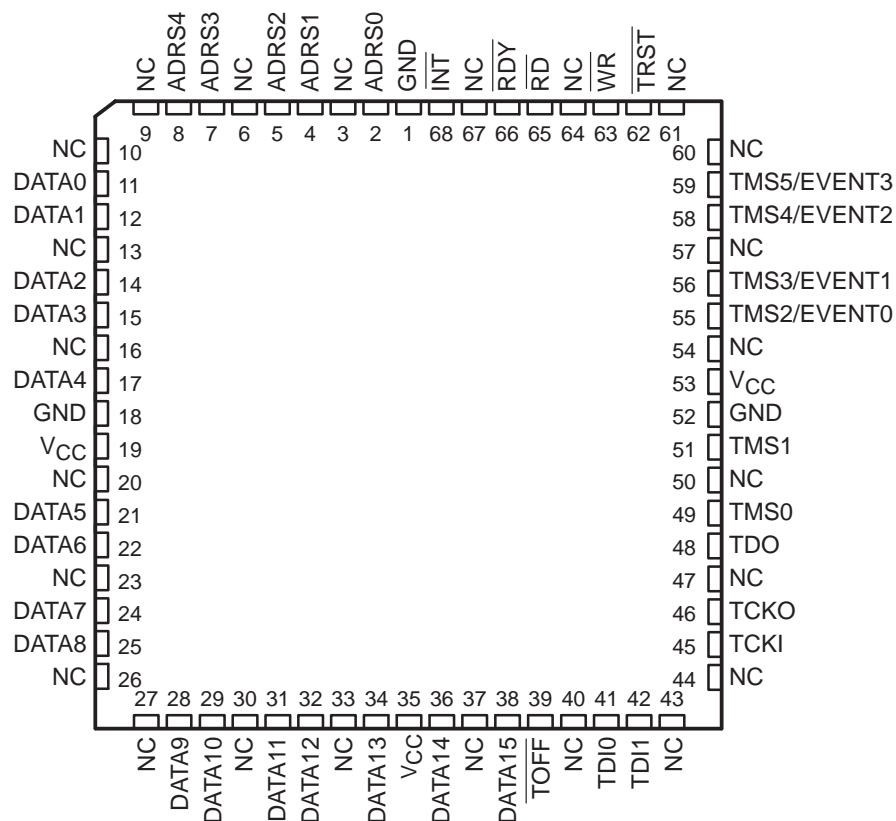

NC – No internal connection

**SN54ACT8990, SN74ACT8990**  
**TEST-BUS CONTROLLERS**  
**IEEE STD 1149.1 (JTAG) TAP MASTERS WITH 16-BIT GENERIC HOST INTERFACES**  
SCAS190E – JUNE 1990 – REVISED JANUARY 1997

**SN74ACT8990 . . . FN PACKAGE**  
**(TOP VIEW)**

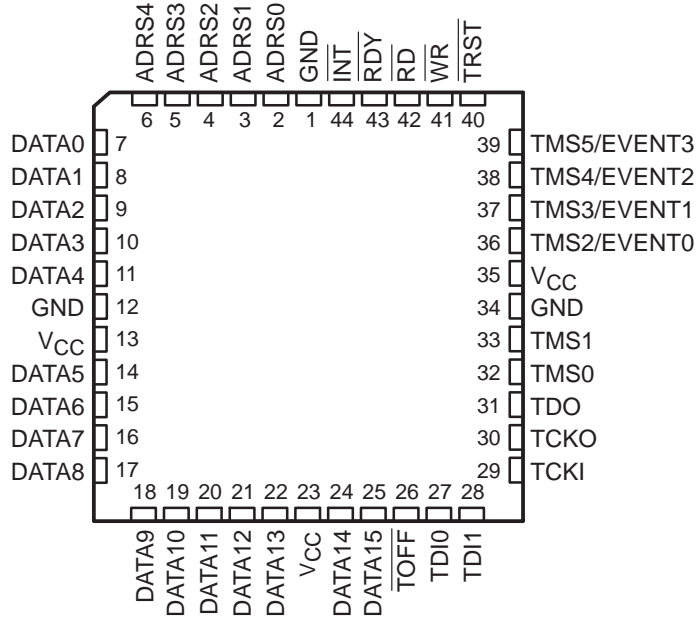

**SN54ACT8990 . . . GB PACKAGE**  
**(TOP VIEW)**

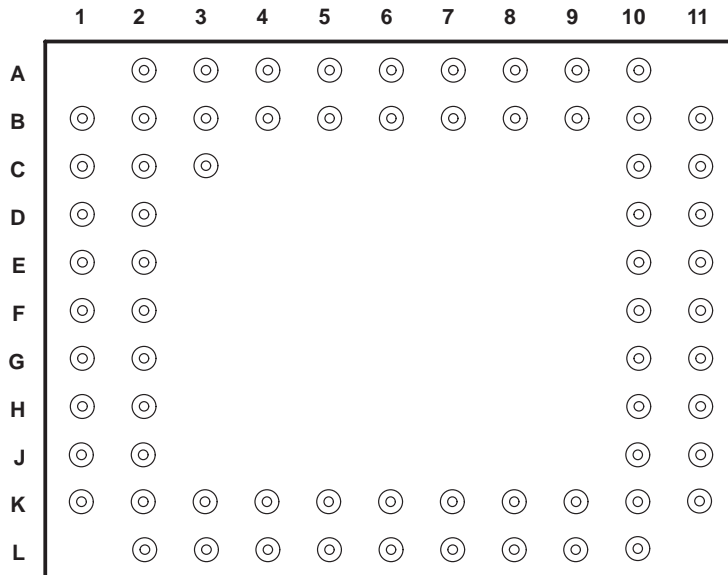

**SN54ACT8990, SN74ACT8990**  
**TEST-BUS CONTROLLERS**  
**IEEE STD 1149.1 (JTAG) TAP MASTERS WITH 16-BIT GENERIC HOST INTERFACES**  
 SCAS190E – JUNE 1990 – REVISED JANUARY 1997

**Table 1. Terminal Assignments**

TERMINAL		TERMINAL		TERMINAL		TERMINAL	
NO.	NAME	NO.	NAME	NO.	NAME	NO.	NAME
A2	NC	B10	NC	F11	NC	K6	NC
A3	ADRS4	B11	NC	G1	DATA5	K7	V <sub>CC</sub>
A4	NC	C1	DATA2	G2	NC	K8	DATA15
A5	ADRS1	C2	DATA1	G10	NC	K9	TDI0
A6	ADRS0	C3	NC	G11	TMS1	K10	NC
A7	NC	C10	TMS4/EVENT2	H1	NC	K11	TCKI
A8	$\overline{\text{INT}}$	C11	TMS5/EVENT3	H2	DATA6	L2	DATA9
A9	$\overline{\text{RD}}$	D1	DATA4	H10	TDO	L3	NC
A10	$\overline{\text{TRST}}$	D2	DATA3	H11	TMS0	L4	DATA12
B1	DATA0	D10	TMS3/EVENT1	J1	DATA8	L5	DATA13
B2	NC	D11	NC	J2	DATA7	L6	NC
B3	ADRS3	E1	NC	J10	TCKO	L7	DATA14
B4	ADRS2	E2	GND	J11	NC	L8	$\overline{\text{TOFF}}$
B5	NC	E10	V <sub>CC</sub>	K1	NC	L9	TDI1
B6	NC	E11	TMS2/EVENT0	K2	NC	L10	NC
B7	GND	F1	V <sub>CC</sub>	K3	DATA10		
B8	$\overline{\text{RDY}}$	F2	NC	K4	DATA11		
B9	$\overline{\text{WR}}$	F10	GND	K5	NC		

NC – No internal connection

**functional block diagram**

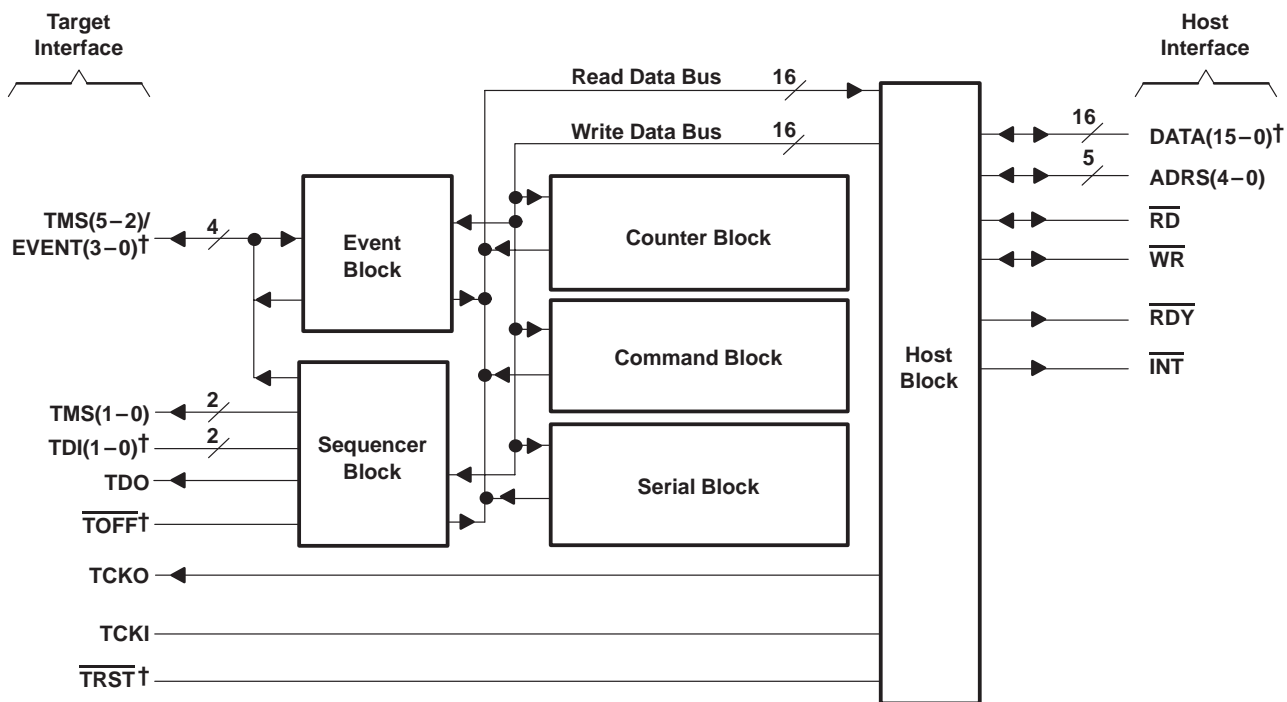

† Inputs have internal pullup resistors.

Terminal Functions

TERMINAL NAME	I/O	DESCRIPTION
ADRS4 – ADRS0	I	Address inputs. ADRS4 – ADRS0 form the 5-bit address bus that interfaces the TBC to its host. These inputs specify the TBC register to be read from or written to.
DATA15 – DATA0	I/O	Data inputs and outputs. DATA15 – DATA0 form the 16-bit bidirectional data bus that interfaces the TBC to its host. Data is read from or written to the TBC register using this data bus.
GND		Ground
$\overline{\text{INT}}$	O	Interrupt. $\overline{\text{INT}}$ transmits an interrupt signal to the host. When the TBC requires service from the host, $\overline{\text{INT}}$ is asserted (low). $\overline{\text{INT}}$ will remain asserted (low) until the host has completed the required service.
NC		No connection
$\overline{\text{RD}}$	I	Read strobe. $\overline{\text{RD}}$ is the active low output enable for the data bus. $\overline{\text{RD}}$ is used as the strobe for reading data from the selected TBC register.
$\overline{\text{RDY}}$	O	Ready. $\overline{\text{RDY}}$ transmits a status signal to the host. When the TBC is ready to accept a read or write operation from the host, $\overline{\text{RDY}}$ is asserted (low). $\overline{\text{RDY}}$ is not asserted (high) when the TBC is in recovery from a read, write, command, or reset operation.
TCKI	I	Test clock input. TCKI is the clock input for the TBC. Most operations of the TBC are synchronous to TCKI. When enabled, all target interface outputs change on the falling edge of TCKI. Sampling of target interface inputs are configured to occur on either the rising edge or falling edge of TCKI.
TCKO	O	Test clock output. TCKO distributes TCK to the target(s). The TCKO is configured to be disabled, constant zero, constant one, or to follow TCKI. When TCKO follows TCKI, it is delayed to match the delay of generating the TDO and TMS signals.
TDI1 – TDI0	I	Test data inputs. The TDI1 – TDI0 serial inputs are used for shifting test data from the target(s). The TDI inputs can be directly connected to the TDO pin(s) of the target(s).
TDO	O	Test data output. TDO is used for shifting test data into the target(s). TDO can be directly connected to the TDI terminal(s) of the target(s).
TMS1 – TMS0	O	Test mode select outputs. These parallel outputs transmit TMS signals to the target(s), which direct them through their TAP controller states. TMS1 – TMS0 can be directly connected to the TMS terminals of the target(s).
TMS5 – TMS2/ EVENT3 – EVENT0	I/O	Test mode select outputs or event inputs/outputs. These I/Os can be configured for use as either TMS outputs or event inputs/outputs. As TMS outputs, they function similarly to TMS1 – TMS0 above. As event I/Os, they can be used to receive/transmit interrupt signals to/from the target(s).
$\overline{\text{TOFF}}$	I	Test-off input. $\overline{\text{TOFF}}$ is the active low output disable for all outputs and I/Os of the target interface (TCKO, TDO, TMS, TMS/EVENT).
$\overline{\text{TRST}}$	I	Test-reset input. $\overline{\text{TRST}}$ is used to initiate hardware and software reset operations of the TBC. Hardware reset begins when $\overline{\text{TRST}}$ is asserted (low). Software reset begins when $\overline{\text{TRST}}$ is released (high) and proceeds synchronously to TCKI to completion in a predetermined number of cycles.
$\overline{\text{WR}}$	I	Write input. $\overline{\text{WR}}$ is the strobe for writing data to a TBC data register. Signals present at the data and address buses are captured on the rising edge of $\overline{\text{WR}}$ .
VCC		Supply voltage

**SN54ACT8990, SN74ACT8990**  
**TEST-BUS CONTROLLERS**  
**IEEE STD 1149.1 (JTAG) TAP MASTERS WITH 16-BIT GENERIC HOST INTERFACES**  
 SCAS190E – JUNE 1990 – REVISED JANUARY 1997

**absolute maximum ratings over operating free-air temperature range (unless otherwise noted)†**

Supply voltage range, $V_{CC}$	–0.5 V to 7 V
Input voltage range, $V_I$ (see Note 1)	–0.5 V to $V_{CC}$
Output voltage range, $V_O$ (see Note 1)	–0.5 V to $V_{CC}$
Input clamp current, $I_{IK}$ ( $V_I < 0$ or $V_I > V_{CC}$ )	±20 mA
Output clamp current, $I_{OK}$ ( $V_O < 0$ or $V_O > V_{CC}$ )	±20 mA
Continuous output current, $I_O$ ( $V_O = 0$ to $V_{CC}$ )	±25 mA
Maximum power dissipation at $T_A = 55^\circ\text{C}$ (in still air) (see Note 2): FN package	1.5W
Storage temperature range, $T_{stg}$	–65°C to 150°C

† Stresses beyond those listed under “absolute maximum ratings” may cause permanent damage to the device. These are stress ratings only, and functional operation of the device at these or any other conditions beyond those indicated under “recommended operating conditions” is not implied. Exposure to absolute-maximum-rated conditions for extended periods may affect device reliability.

- NOTES: 1. The input and output voltage ratings may be exceeded if the input and output clamp-current ratings are observed.  
 2. The maximum package power dissipation is calculated using a junction temperature of 150°C and a board trace length of 75 mils. For more information, refer to the *Package Thermal Considerations* application note in the *ABT Advanced BiCMOS Technology Data Book*, literature number SCBD002.

**recommended operating conditions**

	SN54ACT8990		SN74ACT8990		UNIT
	MIN	MAX	MIN	MAX	
$V_{CC}$ Supply voltage	4.5	5.5	4.5	5.5	V
$V_{IH}$ High-level input voltage	2		2		V
$V_{IL}$ Low-level input voltage		0.8		0.8	V
$V_I$ Input voltage	0	$V_{CC}$	0	$V_{CC}$	V
$V_O$ Output voltage	0	$V_{CC}$	0	$V_{CC}$	V
$I_{OH}$ High-level output current		–8		–8	mA
$I_{OL}$ Low-level output current		8		8	mA
$T_A$ Operating free-air temperature	–55	125	0	70	°C

SN54ACT8990, SN74ACT8990  
TEST-BUS CONTROLLERS

IEEE STD 1149.1 (JTAG) TAP MASTERS WITH 16-BIT GENERIC HOST INTERFACES

SCAS190E – JUNE 1990 – REVISED JANUARY 1997

electrical characteristics over recommended operating free-air temperature range (unless otherwise noted)

PARAMETER	TEST CONDITIONS	T <sub>A</sub> = 25°C			SN54ACT8990		SN74ACT8990		UNIT
		MIN	TYP†	MAX	MIN	MAX	MIN	MAX	
V <sub>OH</sub>	V <sub>CC</sub> = 4.5 V	I <sub>OH</sub> = -20 μA	4.4			4.4		4.4	V
		I <sub>OH</sub> = -8 mA	3.7			3.7		3.7	
	V <sub>CC</sub> = 5.5 V	I <sub>OH</sub> = -20 μA	5.4			5.4		5.4	
		I <sub>OH</sub> = -8 mA	4.7			4.7		4.7	
V <sub>OL</sub>	V <sub>CC</sub> = 4.5 V to 5.5 V	I <sub>OL</sub> = 20 μA				0.1		0.1	V
		I <sub>OL</sub> = 8 mA				0.5		0.5	
I <sub>I</sub>	ADRS, $\overline{\text{RD}}$ , WR, TCKI	V <sub>CC</sub> = 5.5 V, V <sub>I</sub> = V <sub>CC</sub> or GND				±1		±1	μA
	TDI, $\overline{\text{TOFF}}$ , TRST	V <sub>CC</sub> = 5.5 V	V <sub>I</sub> = V <sub>CC</sub>			±1		±1	
I <sub>OZ</sub> ‡	INT, RDY, TCKO, TDO, TMS	V <sub>CC</sub> = 5.5 V, V <sub>O</sub> = V <sub>CC</sub> or GND				±10		±10	μA
	DATA, TMS/EVENT	V <sub>CC</sub> = 5.5 V	V <sub>O</sub> = V <sub>CC</sub>			±10		±10	
I <sub>CC</sub>	V <sub>CC</sub> = 5.5 V, I <sub>O</sub> = 0, V <sub>I</sub> = V <sub>CC</sub> or GND					450*		450	μA
		V <sub>CC</sub> = 5.5 V, C <sub>L</sub> = 50 pF f <sub>clock</sub> = 30 MHz				100			mA
C <sub>i</sub>	V <sub>I</sub> = V <sub>CC</sub> or GND					5*			pF
C <sub>io</sub>	V <sub>I</sub> = V <sub>CC</sub> or GND					9*			pF
C <sub>o</sub>	V <sub>I</sub> = V <sub>CC</sub> or GND					8*			pF

\* On products compliant to MIL-PRF-38535, this parameter does not apply.

† Typical values are at V<sub>CC</sub> = 5 V.

‡ For I/O ports, the parameter I<sub>OZ</sub> includes the input leakage.

**SN54ACT8990, SN74ACT8990**  
**TEST-BUS CONTROLLERS**  
**IEEE STD 1149.1 (JTAG) TAP MASTERS WITH 16-BIT GENERIC HOST INTERFACES**  
 SCAS190E – JUNE 1990 – REVISED JANUARY 1997

**timing requirements over recommended ranges of supply voltage and operating free-air temperature (see Figure 1)**

		SN54ACT8990		SN74ACT8990		UNIT
		MIN	MAX	MIN	MAX	
$f_{\text{clock}}$	Clock frequency	0	30	0	30	MHz
$t_w$	Pulse duration	$\overline{\text{RD}}$ low†		5.5		ns
		$\overline{\text{WR}}$ low	5.5	5.5		ns
		EVENT high or low	8	8		
		TCKI high or low	10.5	10.5		
		$\overline{\text{TRST}}$ low	6	6		
$t_{\text{su}}$	Setup time	ADRS† before $\overline{\text{RD}}$ ↑		6.5		ns
		ADRS before $\overline{\text{WR}}$ ↑	6.5	6.5		ns
		DATA before $\overline{\text{WR}}$ ↑	6	6		
		EVENT before TCKI↑	6	5.5		
		EVENT before TCKI↓	5	5		
		TDI before TCKI↑	2	2		
		TDI before TCKI↓	2	2		
$t_h$	Hold time	ADRS† after $\overline{\text{RD}}$ ↑		5		ns
		ADRS after $\overline{\text{WR}}$ ↑	5.5	5		ns
		DATA after $\overline{\text{WR}}$ ↑	5.5	5.5		
		EVENT after TCKI↑	5.5	5		
		EVENT after TCKI↓	5	5		
		TDI after TCKI↑	4	2.5		
		TDI after TCKI↓	4	2.5		

† Applies only in the case where ADRS (4-0) = 10110 (read buffer).



SN54ACT8990, SN74ACT8990  
TEST-BUS CONTROLLERS

IEEE STD 1149.1 (JTAG) TAP MASTERS WITH 16-BIT GENERIC HOST INTERFACES

SCAS190E – JUNE 1990 – REVISED JANUARY 1997

switching characteristics over recommended ranges of supply voltage and operating free-air temperature (see Figure 1)

PARAMETER	FROM (INPUT)	TO (OUTPUT)	SN54ACT8990		SN74ACT8990		UNIT
			MIN	MAX	MIN	MAX	
f <sub>max</sub>			30		30		MHz
t <sub>PLH</sub>	ADRS	DATA	8	43	19.5	39.3	ns
t <sub>PHL</sub>			8	43	19.5	39.3	
t <sub>PLH</sub>	$\overline{RD}\uparrow$	$\overline{RDY}$	5.3	17	5.3	13.8	ns
	$\overline{WR}\uparrow$		2.5	16	2.5	13	
t <sub>PLH</sub>	TCKI $\uparrow$	$\overline{INT}$	3.7	16	3.7	12.9	ns
t <sub>PHL</sub>			5.5	15	5.5	13.1	
t <sub>PHL</sub>	TCKI $\uparrow$	$\overline{RDY}$	4.4	15	4.4	13.4	ns
t <sub>PLH</sub>	TCKI $\uparrow$	TCKO	3.3	17	3.3	14.1	ns
t <sub>PLH</sub>	TCKI $\downarrow$	TCKO	2.3	19	2.3	15.9	ns
t <sub>PHL</sub>			3.6	17	3.6	15.6	
t <sub>PLH</sub>	TCKI $\downarrow$	TDO	2.9	19	2.9	17.5	ns
t <sub>PHL</sub>			5.2	20	5.2	17.9	
t <sub>PLH</sub>	TCKI $\downarrow$	TMS	3.1	19	3.1	17.5	ns
t <sub>PHL</sub>			5.1	19	5.1	18.2	
t <sub>PLH</sub>	TCKI $\downarrow$	TMS/EVENT	1.5	19	1.5	17.5	ns
t <sub>PHL</sub>			3.5	20	3.5	18.9	
t <sub>PZH</sub>	$\overline{RD}\downarrow$	DATA	3.8	21	3.8	17.6	ns
t <sub>PZL</sub>			6.8	28	6.8	22.6	
t <sub>PZH</sub>	TCKI $\uparrow$	$\overline{INT}$	4.9	19	4.9	15.3	ns
		$\overline{RDY}$	3.6	19	3.6	15.3	
t <sub>PZH</sub>	TCKI $\downarrow$	TCKO	4.1	23	4.1	19.2	ns
t <sub>PZL</sub>			4.8	20	4.8	17.4	
t <sub>PZH</sub>	TCKI $\downarrow$	TDO	4.3	22	4.3	19.5	ns
t <sub>PZL</sub>			5	20	5	17.7	
t <sub>PZH</sub>	TCKI $\downarrow$	TMS	4.6	23	4.6	19.9	ns
t <sub>PZL</sub>			5.1	20	5.1	18.5	
t <sub>PZH</sub>	TCKI $\downarrow$	TMS/EVENT	2	21	2	18.8	ns
t <sub>PZL</sub>			3.2	20	3.2	18.7	
t <sub>PZH</sub>	$\overline{TOFF}\uparrow$	TCKO	4.6	16	4.6	12.2	ns
t <sub>PZL</sub>			3.1	14	3.1	10.3	
t <sub>PZH</sub>	$\overline{TOFF}\uparrow$	TDO	4.4	15	4.4	12.2	ns
t <sub>PZL</sub>			3.5	14	3.5	10.8	
t <sub>PZH</sub>	$\overline{TOFF}\uparrow$	TMS	3.1	16.2	3.1	14.7	ns
t <sub>PZL</sub>			1.9	16.7	1.9	13.6	

**SN54ACT8990, SN74ACT8990**  
**TEST-BUS CONTROLLERS**  
**IEEE STD 1149.1 (JTAG) TAP MASTERS WITH 16-BIT GENERIC HOST INTERFACES**  
SCAS190E – JUNE 1990 – REVISED JANUARY 1997

**switching characteristics over recommended ranges of supply voltage and operating free-air temperature (continued) (see Figure 1)**

PARAMETER	FROM (INPUT)	TO (OUTPUT)	SN54ACT8990		SN74ACT8990		UNIT
			MIN	MAX	MIN	MAX	
t <sub>PZH</sub>	$\overline{\text{TOFF}}\uparrow$	TMS/EVENT	2.3	15.3	2.3	13.8	ns
t <sub>PZL</sub>			2.7	16.4	2.7	13.9	
t <sub>PHZ</sub>	$\overline{\text{RD}}\uparrow$	DATA	3.8	18.4	3.8	15.4	ns
t <sub>PLZ</sub>			4.1	17.1	4.1	14.8	
t <sub>PHZ</sub>	TCKI $\downarrow$	TCKO	6.7	20.4	6.7	19.8	ns
t <sub>PLZ</sub>			4.8	21.1	4.8	20.4	
t <sub>PHZ</sub>	TCKI $\downarrow$	TDO	5.1	21.7	5.1	21.3	ns
t <sub>PLZ</sub>			5	20.7	5	20.3	
t <sub>PHZ</sub>	TCKI $\downarrow$	TMS	6.9	22.4	6.9	21.9	ns
t <sub>PLZ</sub>			4.6	20.6	4.6	20.1	
t <sub>PHZ</sub>	TCKI $\downarrow$	TMS/EVENT	4.7	22.5	4.7	22.1	ns
t <sub>PLZ</sub>			2.8	20.5	2.8	20.1	
t <sub>PHZ</sub>	$\overline{\text{TOFF}}\downarrow$	TCKO	5	15.6	5	15.4	ns
t <sub>PLZ</sub>			4.4	15.5	4.4	15.3	
t <sub>PHZ</sub>	$\overline{\text{TOFF}}\downarrow$	TDO	5.6	16.6	5.6	16.5	ns
t <sub>PLZ</sub>			4.6	15.4	4.6	15.4	
t <sub>PHZ</sub>	$\overline{\text{TOFF}}\downarrow$	TMS	4.8	19.1	4.8	17.1	ns
t <sub>PLZ</sub>			4.4	17	4.4	15.8	
t <sub>PHZ</sub>	$\overline{\text{TOFF}}\downarrow$	TMS/EVENT	4.5	18.8	4.5	17.3	ns
t <sub>PLZ</sub>			2.4	17.1	2.4	16.2	
t <sub>PHZ</sub>	$\overline{\text{TRST}}\downarrow$	DATA	5.7	23	5.7	20.8	ns
t <sub>PLZ</sub>			4.2	20.3	4.2	20	
t <sub>PHZ</sub>	$\overline{\text{TRST}}\downarrow$	$\overline{\text{INT}}$	6	19.6	8	19.5	ns
t <sub>PLZ</sub>			6.1	18	6.1	17.8	
t <sub>PHZ</sub>	$\overline{\text{TRST}}\downarrow$	$\overline{\text{RDY}}$	6.5	18.8	6.5	18.7	ns
t <sub>PLZ</sub>			4.8	17.8	4.8	17.8	
t <sub>PHZ</sub>	$\overline{\text{TRST}}\downarrow$	TMS/EVENT	6	21.1	6	21.1	ns
t <sub>PLZ</sub>			4.2	20	4.2	19.9	

PARAMETER MEASUREMENT INFORMATION

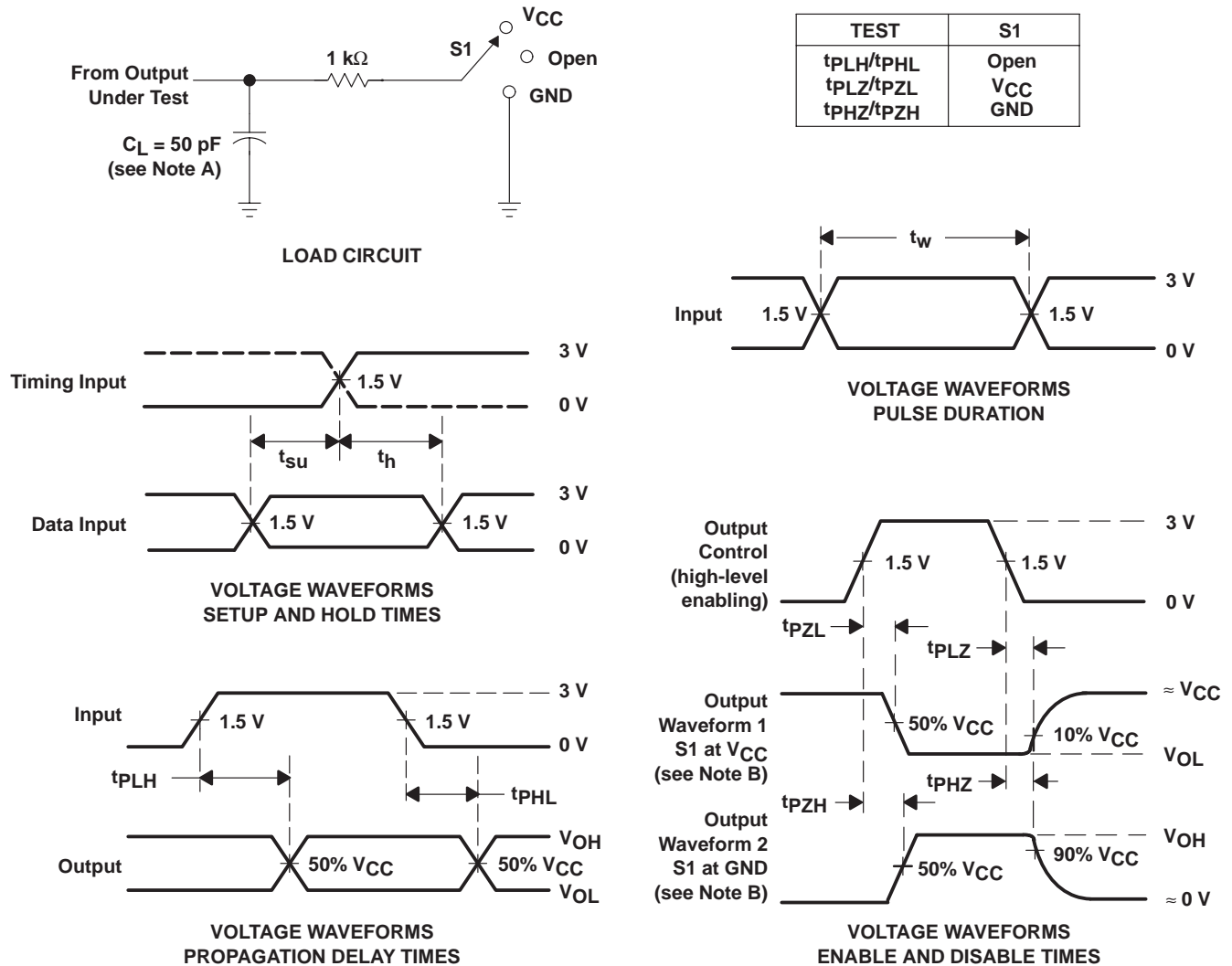

- NOTES:
- A.  $C_L$  includes probe and jig capacitance.
  - B. Waveform 1 is for an output with internal conditions such that the output is low except when disabled by the output control. Waveform 2 is for an output with internal conditions such that the output is high except when disabled by the output control.
  - C. All input pulses are supplied by generators having the following characteristics:  $PRR \leq 10 \text{ MHz}$ ,  $Z_O = 50 \Omega$ ,  $t_r \leq 3 \text{ ns}$ ,  $t_f \leq 3 \text{ ns}$ . For testing pulse duration:  $t_r = t_f = 1 \text{ to } 3 \text{ ns}$ . Pulse polarity can be either high-to-low-to-high or low-to-high-to-low.
  - D. The outputs are measured one at a time with one transition per measurement.

Figure 1. Load Circuit and Voltage Waveforms

**PACKAGING INFORMATION**

Orderable Device	Status <sup>(1)</sup>	Package Type	Package Drawing	Pins	Package Qty	Eco Plan <sup>(2)</sup>	Lead/Ball Finish	MSL Peak Temp <sup>(3)</sup>
5962-9322801MXA	ACTIVE	CFP	HV	68	1	TBD	Call TI	Level-NC-NC-NC
5962-9322801MYA	ACTIVE	CPGA	GB	68	1	TBD	Call TI	Level-NC-NC-NC
SN74ACT8990FN	ACTIVE	PLCC	FN	44	26	TBD	Call TI	Level-3-220C-168 HR
SN74ACT8990FNR	ACTIVE	PLCC	FN	44	500	TBD	Call TI	Level-3-220C-168 HR
SNJ54ACT8990GB	ACTIVE	CPGA	GB	68	1	TBD	Call TI	Level-NC-NC-NC
SNJ54ACT8990HV	ACTIVE	CFP	HV	68	1	TBD	Call TI	Level-NC-NC-NC

<sup>(1)</sup> The marketing status values are defined as follows:

**ACTIVE:** Product device recommended for new designs.

**LIFEBUY:** TI has announced that the device will be discontinued, and a lifetime-buy period is in effect.

**NRND:** Not recommended for new designs. Device is in production to support existing customers, but TI does not recommend using this part in a new design.

**PREVIEW:** Device has been announced but is not in production. Samples may or may not be available.

**OBSOLETE:** TI has discontinued the production of the device.

<sup>(2)</sup> Eco Plan - The planned eco-friendly classification: Pb-Free (RoHS) or Green (RoHS & no Sb/Br) - please check <http://www.ti.com/productcontent> for the latest availability information and additional product content details.

**TBD:** The Pb-Free/Green conversion plan has not been defined.

**Pb-Free (RoHS):** TI's terms "Lead-Free" or "Pb-Free" mean semiconductor products that are compatible with the current RoHS requirements for all 6 substances, including the requirement that lead not exceed 0.1% by weight in homogeneous materials. Where designed to be soldered at high temperatures, TI Pb-Free products are suitable for use in specified lead-free processes.

**Green (RoHS & no Sb/Br):** TI defines "Green" to mean Pb-Free (RoHS compatible), and free of Bromine (Br) and Antimony (Sb) based flame retardants (Br or Sb do not exceed 0.1% by weight in homogeneous material)

<sup>(3)</sup> MSL, Peak Temp. -- The Moisture Sensitivity Level rating according to the JEDEC industry standard classifications, and peak solder temperature.

**Important Information and Disclaimer:**The information provided on this page represents TI's knowledge and belief as of the date that it is provided. TI bases its knowledge and belief on information provided by third parties, and makes no representation or warranty as to the accuracy of such information. Efforts are underway to better integrate information from third parties. TI has taken and continues to take reasonable steps to provide representative and accurate information but may not have conducted destructive testing or chemical analysis on incoming materials and chemicals. TI and TI suppliers consider certain information to be proprietary, and thus CAS numbers and other limited information may not be available for release.

In no event shall TI's liability arising out of such information exceed the total purchase price of the TI part(s) at issue in this document sold by TI to Customer on an annual basis.

# MECHANICAL DATA

HV (S-GQFP-F68)

CERAMIC QUAD FLATPACK

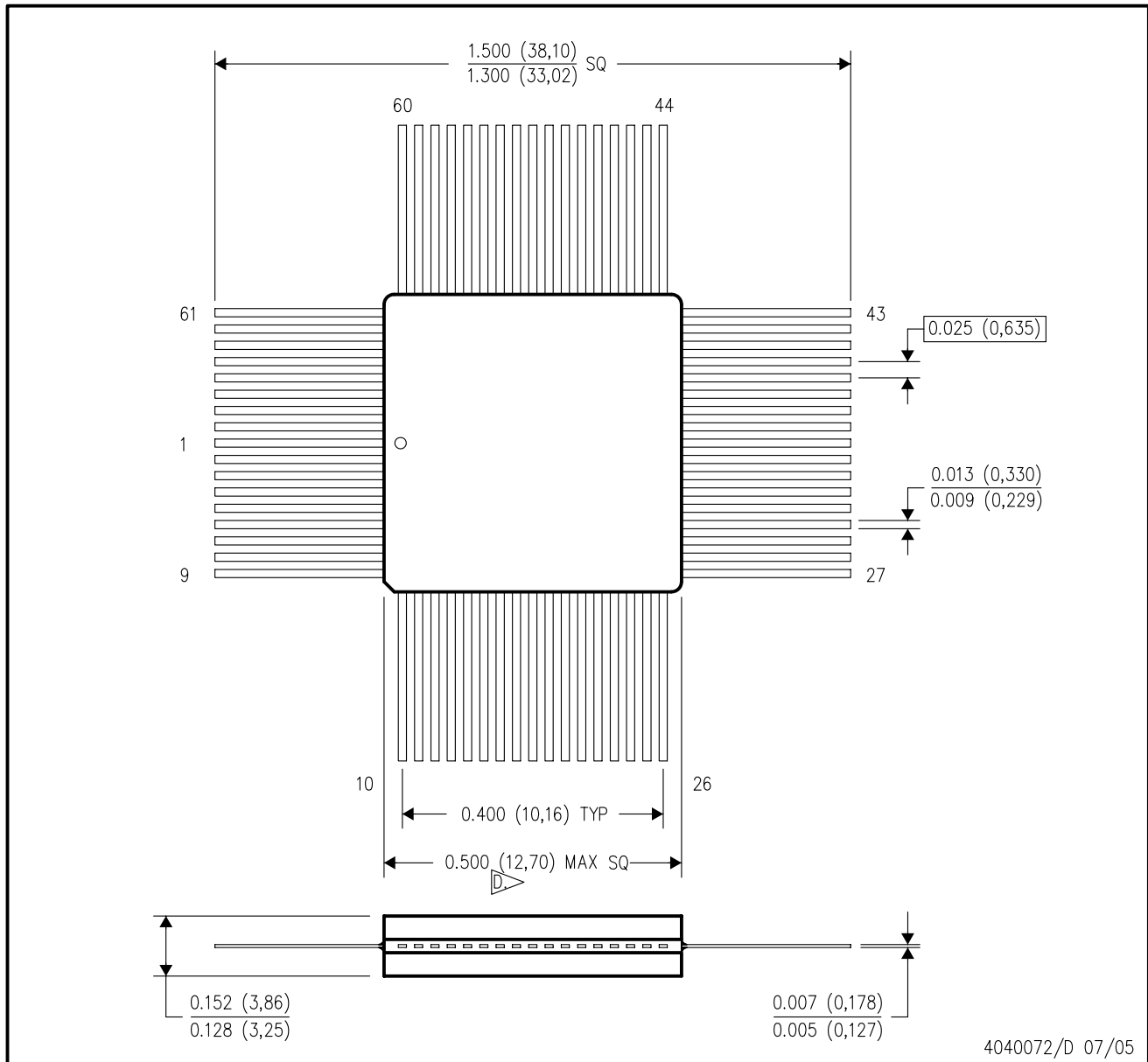

# MECHANICAL DATA

MPLC004A – OCTOBER 1994

FN (S-PQCC-J\*\*)

PLASTIC J-LEADED CHIP CARRIER

20 PIN SHOWN

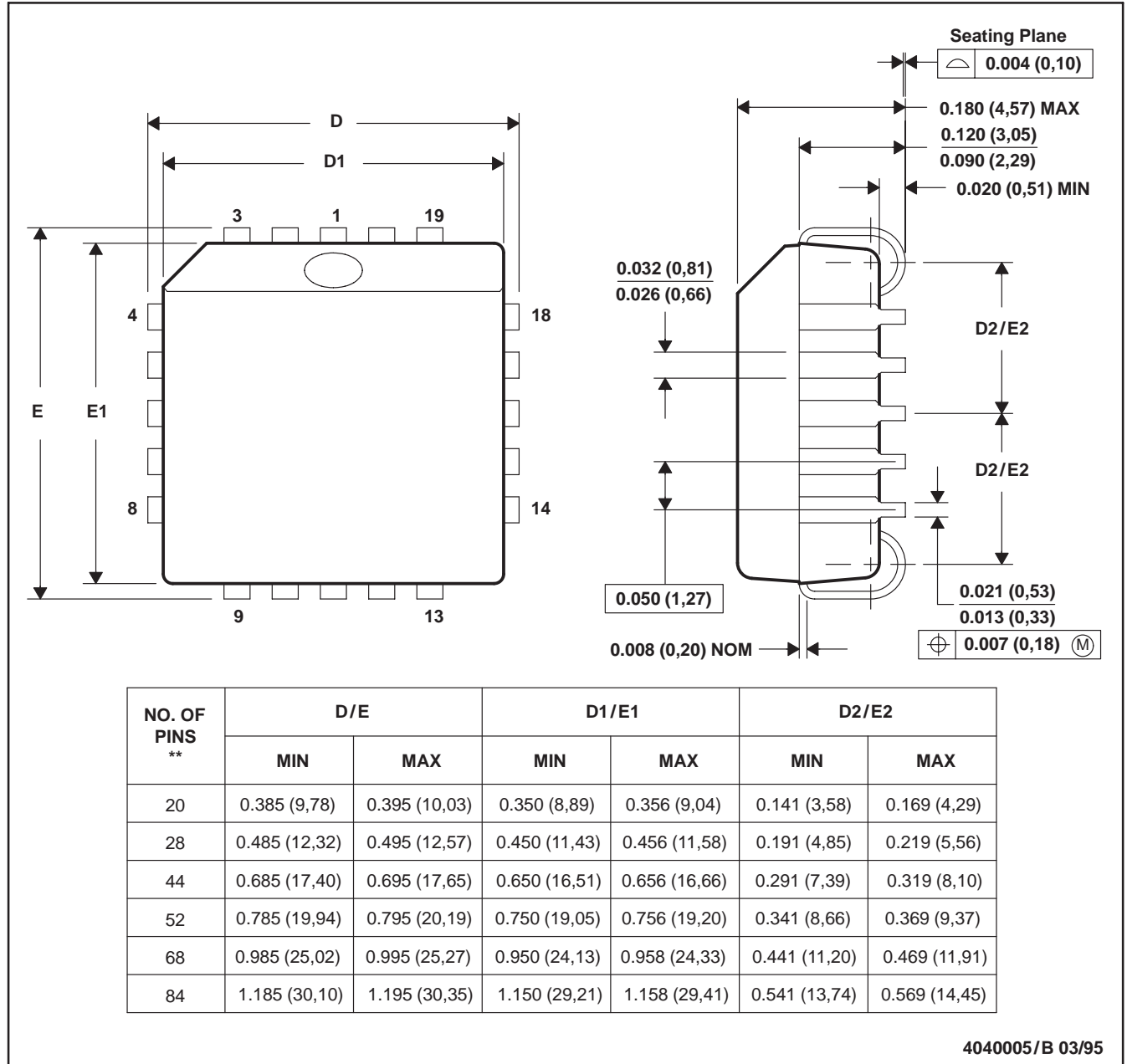

- NOTES: A. All linear dimensions are in inches (millimeters).  
 B. This drawing is subject to change without notice.  
 C. Falls within JEDEC MS-018

## IMPORTANT NOTICE

Texas Instruments Incorporated and its subsidiaries (TI) reserve the right to make corrections, modifications, enhancements, improvements, and other changes to its products and services at any time and to discontinue any product or service without notice. Customers should obtain the latest relevant information before placing orders and should verify that such information is current and complete. All products are sold subject to TI's terms and conditions of sale supplied at the time of order acknowledgment.

TI warrants performance of its hardware products to the specifications applicable at the time of sale in accordance with TI's standard warranty. Testing and other quality control techniques are used to the extent TI deems necessary to support this warranty. Except where mandated by government requirements, testing of all parameters of each product is not necessarily performed.

TI assumes no liability for applications assistance or customer product design. Customers are responsible for their products and applications using TI components. To minimize the risks associated with customer products and applications, customers should provide adequate design and operating safeguards.

TI does not warrant or represent that any license, either express or implied, is granted under any TI patent right, copyright, mask work right, or other TI intellectual property right relating to any combination, machine, or process in which TI products or services are used. Information published by TI regarding third-party products or services does not constitute a license from TI to use such products or services or a warranty or endorsement thereof. Use of such information may require a license from a third party under the patents or other intellectual property of the third party, or a license from TI under the patents or other intellectual property of TI.

Reproduction of information in TI data books or data sheets is permissible only if reproduction is without alteration and is accompanied by all associated warranties, conditions, limitations, and notices. Reproduction of this information with alteration is an unfair and deceptive business practice. TI is not responsible or liable for such altered documentation.

Resale of TI products or services with statements different from or beyond the parameters stated by TI for that product or service voids all express and any implied warranties for the associated TI product or service and is an unfair and deceptive business practice. TI is not responsible or liable for any such statements.

Following are URLs where you can obtain information on other Texas Instruments products and application solutions:

<b>Products</b>		<b>Applications</b>	
Amplifiers	<a href="http://amplifier.ti.com">amplifier.ti.com</a>	Audio	<a href="http://www.ti.com/audio">www.ti.com/audio</a>
Data Converters	<a href="http://dataconverter.ti.com">dataconverter.ti.com</a>	Automotive	<a href="http://www.ti.com/automotive">www.ti.com/automotive</a>
DSP	<a href="http://dsp.ti.com">dsp.ti.com</a>	Broadband	<a href="http://www.ti.com/broadband">www.ti.com/broadband</a>
Interface	<a href="http://interface.ti.com">interface.ti.com</a>	Digital Control	<a href="http://www.ti.com/digitalcontrol">www.ti.com/digitalcontrol</a>
Logic	<a href="http://logic.ti.com">logic.ti.com</a>	Military	<a href="http://www.ti.com/military">www.ti.com/military</a>
Power Mgmt	<a href="http://power.ti.com">power.ti.com</a>	Optical Networking	<a href="http://www.ti.com/opticalnetwork">www.ti.com/opticalnetwork</a>
Microcontrollers	<a href="http://microcontroller.ti.com">microcontroller.ti.com</a>	Security	<a href="http://www.ti.com/security">www.ti.com/security</a>
		Telephony	<a href="http://www.ti.com/telephony">www.ti.com/telephony</a>
		Video & Imaging	<a href="http://www.ti.com/video">www.ti.com/video</a>
		Wireless	<a href="http://www.ti.com/wireless">www.ti.com/wireless</a>

Mailing Address: Texas Instruments  
Post Office Box 655303 Dallas, Texas 75265