

Silicon Protection Circuits

TVS Rail Clamp Diode Array with an Avalanche Diode

SP0506CA, SP0518CAA

NEW

This family of rail clamp or “diode steering” arrays are designed for very low capacitance ESD protection and is offered in small surface mount packages. An Avalanche diode has been added between VP and VN to suppress transients on the supply rails. The multi-channel devices are used to help protect high speed sensitive digital or analog input circuits on data, signal, or control lines with unipolar voltage levels up to 5VDC. The state-of-the-art structure is designed to suppress ESD and other transient over-voltage events to meet the International Electrotechnical Compatibility (IEC) transient immunity standards IEC 61000-4-2 for Electrostatic Discharge Requirements.

The monolithic silicon devices are comprised of specially designed low capacitance structures for transient voltage suppression (TVS). The size and shape of these structures have been tailored for transient protection. The very low capacitance and clamp voltage are ideal for ultra high speed signal line protection.

Ordering Information

Part Number	CH	Package Type	Quantity Per Reel
SP0506CAAT	6	MSOP8	4000
SP0506CABT	6	SOIC8	2500
SP0518CAAT	18	QSOP24	2500

Schematic

SP0506CAAT
and
SP0506CABT

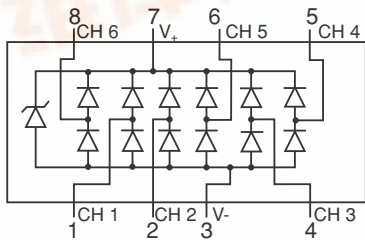

SP0518CAAT

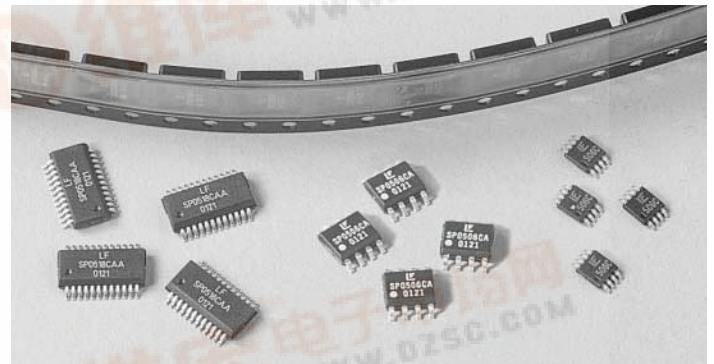
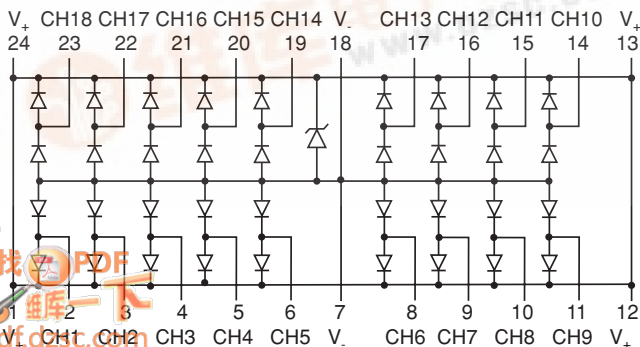

Features

- A low capacitance 2, 6 and 18 channel array of rail clamp current steering diodes in small surface mount packages
- ESD Protection Capability (SP0506CA)
 - IEC 61000-4-2, Direct Discharge 8kV (Level 4)
 - MIL STD 3015.7 15kV
- ESD Protection Capability (SP0518CA)
 - IEC 61000-4-2, Direct Discharge 15kV (Level 4)
 - MIL STD 3015.7 15kV
- Input Protection for Applications Up to 5VDC
- Low Input Capacitance 3 - 7pF Typical
- Low Clamp Voltage $V_{rail} + 13V$ Max
- Low Input Leakage 100nA Typ
- Operating Temperature Range 20°C to 85°C

Applications

- Computer ports
- Personal Digital Assistants (PDA)
- Portable handheld equipment (Laptop, Palmtop computers)
- Computer port, keyboard (USB1.1)

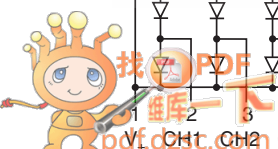

Silicon Protection Circuits

TVS Rail Clamp Diode Array with an Avalanche Diode

SP0506CA, SP0518CAA

Electrical Specifications $T_A = 25^\circ\text{C}$ Unless Otherwise Specified

PARAMETER	TEST CONDITIONS	MIN	TYPICAL	MAX	UNITS
Operating Supply Voltage	$V_p - V_n$	-	-	5.5	V
Supply Current	$V_p - V_n = 5.5\text{V}$			10	μA
Channel Leakage Current			0.1	0.1	μA
Signal Clamp Voltage	15kV ESD HBM				
Positive				$V_p + 13$	V
Negative				$V_N - 13$	V
Diode Forward Voltage		0.65		0.95	V
Maximum Forward current					
SP0506x				20	mA
SP0518				40	mA
Maximum DC Input voltage		$V_N - 0.5$		$V_p + 0.5$	V
ESD Test Level (SP0506x)					
IEC-61000-4-2, Contact discharge		8			kV
MIL-STD-883 Method 3015 (HBM)		15			kV
ESD Test Level (SP0518)					
IEC-61000-4-2, Contact discharge		15			kV
MIL-STD-883 Method 3015 (HBM)		15			kV
Capacitance					
SP0506x	2.5VDC @ 1Mhz		3	6	pF
SP0518	2.5VDC @ 1Mhz		7	12	pF
Turn on/off Time			<1		ns
Temperature Range					
Operating		- 20		+85	$^\circ\text{C}$
Storage		- 65		+150	$^\circ\text{C}$

Typical Capacitance

SP0506x

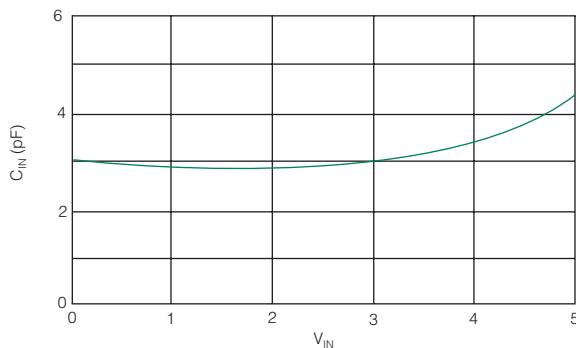

Typical Variation of C_{IN} with V_{IN}
 $(V_p=5\text{V}, V_N=0\text{V}, 0.1\mu\text{F}$ chip capacitor between V_p & V_N)

SP0518

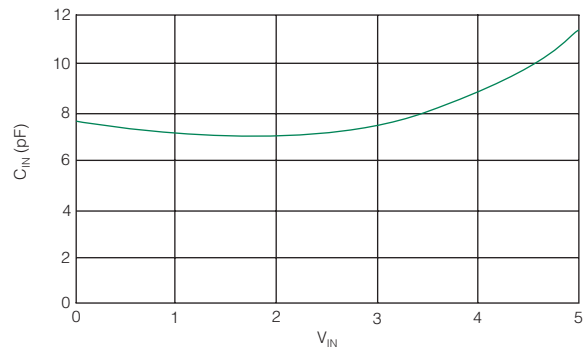

Typical Variation of C_{IN} with V_{IN}
 $(V_p=5\text{V}, V_N=0\text{V}, 0.1\mu\text{F}$ chip capacitor between V_p & V_N)

SP0506CA, SP0518CAA

Outline Drawings

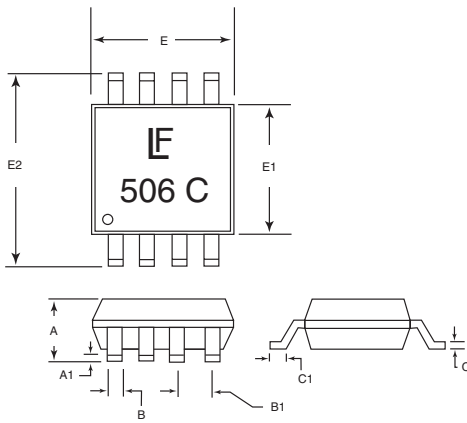

SP0506CAA - MSOP 8

Recommended Pad Layout

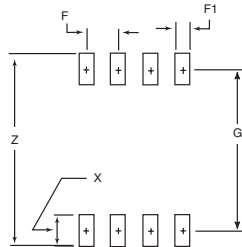

Package	MSOP 8			
	mm		inches	
	min	max	min	max
E	2.90	3.10	.114	.122
E1	2.90	3.10	.114	.122
E2	4.78	4.98	.188	.196
A	0.87	1.17	.034	.046
A1	0.05	0.25	.002	.010
B	-	0.30TYP	-	.012TYP
B1	-	0.65TYP	-	.25TYP
C	-	0.18TYP	-	.007TYP
C1	0.52	0.54	.017	.025
F	-	0.65	-	.0256
F1	-	0.38	-	.015
Z	-	5.28	-	.208
X	-	1.04	-	.041
G	-	4.24	-	.167

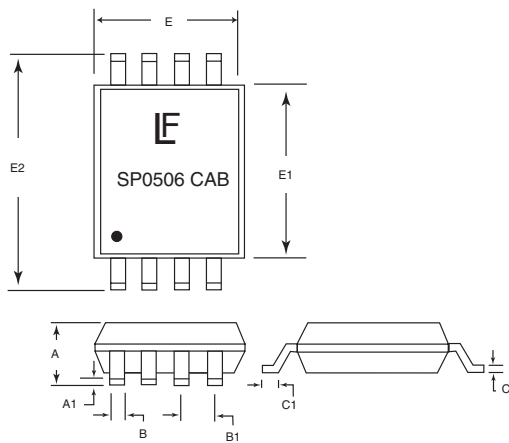

SP0506CAB - SOIC 8

Recommended Pad Layout

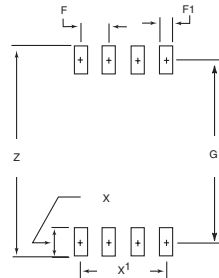

Package	SOIC 8			
	mm		inches	
	min	max	min	max
E	4.80	5.00	.189	.197
E1	3.80	4.19	.150	.165
E2	5.80	6.20	.228	.244
A	1.35	1.75	.053	.069
A1	0.10	0.25	.004	.010
B	0.33	0.51TYP	.013	.020TYP
B1	-	1.27TYP	-	0.050TYP
C	0.19	0.25	.007	.010
C1	0.40	1.27	.016	.050
F	-	1.27	-	.05
F1	0.60	0.80	.02	.03
Z	7.20	7.40	-	.29
X	-	2.40	-	.09
X'	-	3.81REF	-	.15REF
G	-	5.00REF	-	.19REF

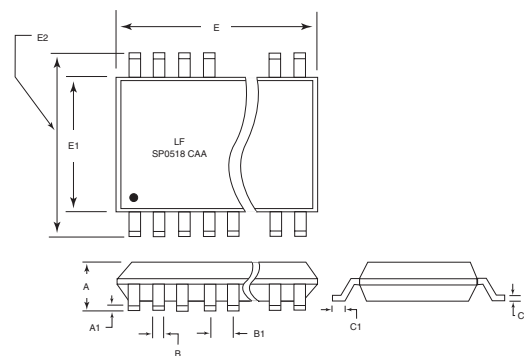

SP0518CAA - QSOP 24

Package	QSOP 24			
	mm		inches	
	min	max	min	max
E	8.56	8.73	.337	.344
E1	3.81	3.98	.150	.157
E2	5.79	6.19	.228	.244
A	1.35	1.75	.053	.069
A1	0.10	0.25	.004	.010
B	0.20TYP	0.30TYP	.008TYP	.012TYP
B1	-	0.64TYP	-	.025TYP
C	0.18	0.25	.007	.010
C1	0.40	1.27	.016	.050