

Electroluminescent Lamp Driver Low Power Applications

- 2.2V-5.0V Battery Operation
- 50nA Maximum Standby Current
- High Voltage Output 160 V_{pp} typical
- Internal Oscillator

APPLICATIONS

- PDAs
- Cellular Phones
- Remote Controls
- Hand Held Computers



DESCRIPTION

The **SP4423** is a high voltage output DC-AC converter that can operate from a 2.2V-6.0V power supply. The **SP4423** is capable of supplying up to 200 V_{pp} signals, making it ideal for driving electroluminescent lamps. The device features 10nA (typical) standby current, for use in low power portable products. An inductor is used to generate the high voltage, and an external capacitor is used to select the oscillator frequency. The **SP4423** is offered in an 8-pin narrow SOIC and 8-pin μ SOIC packages. For delivery in die form, please consult the factory.

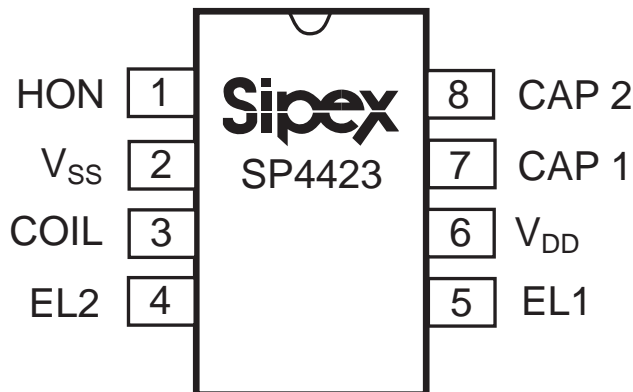

Block Diagram

ABSOLUTE MAXIMUM RATINGS

These are stress ratings only and functional operation of the device at these ratings or any other above those indicated in the operation sections of the specifications below is not implied. Exposure to absolute maximum rating conditions for extended periods of time may affect reliability.

V _{DD}	7.0V
Input Voltages/Currents	
HON (pin1).....	-0.5V to (V _{DD} +0.5V)
COIL (pin3).....	60mA
Lamp Outputs.....	230V _{pp}
Storage Temperature.....	-65°C to +150°C

SPECIFICATIONS

(T = 25°C; V_{DD} = 3.0V; Lamp Capacitance = 6000pF; Coil = 20 mH (R_s = 70Ω); C_{OSC} = 150pF unless otherwise noted)

PARAMETER	MIN.	TYP.	MAX.	UNITS	CONDITIONS
Supply Voltage, V _{DD}	2.2	3.0	6.0	V	
Supply Current, I _{COIL} +I _{DD}		5 12	12 40	mA	V _{DD} =3.0V, V _{HON} =3.0V V _{DD} =6.0V, V _{HON} =6.0V
Coil Voltage, V _{COIL}	V _{DD}		6.0	V	
HON Input Voltage, V _{HON} LOW: EL off HIGH: EL on	-0.25 V _{DD} -0.25	0 V _{DD}	0.25V V _{DD} +0.25	V	
HON Current, EL on		25 50	60 120	μA	V _{HON} =V _{DD} =3.0V V _{HON} =V _{DD} =6.0V
Shutdown Current, I _{SD} =I _{COIL} +I _{DD}		10 0.3	200 1	nA μA	V _{DD} =3.0V, V _{HON} =0V V _{DD} =6.0V, V _{HON} =0V
INDUCTOR DRIVE					
Coil Frequency, f _{COIL} =f _{LAMP} x32		9.6		kHz	
Coil Duty Cycle		75		%	
Peak Coil Current, I _{PK-COIL}			60	mA	Guaranteed by design.
EL LAMP OUTPUT					
EL Lamp Frequency, f _{LAMP}	200 225	300 300	400 450	Hz	V _{DD} =3.0V V _{DD} =6.0V
Peak to Peak Output Voltage	110	150		V _{pp}	

This data sheet specifies environmental parameters, final test conditions and limits as well suggested operating conditions. For applications which require performance beyond the specified conditions and or limits please consult the factory.

Bonding Diagram:

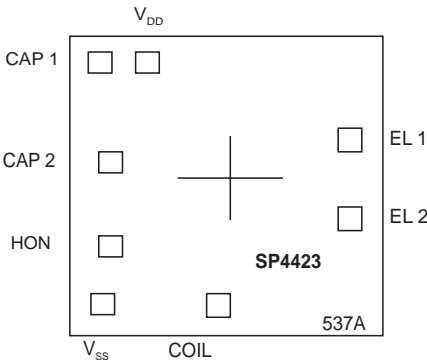

Power Dissipation Per Package

8-pin NSOIC (derate 6.14mW/°C above +70°C).....	500mW
8-pin μSOIC (derate 4.85mW/°C above +70°C).....	390mW

The information furnished herein by Sipex has been carefully reviewed for accuracy and reliability. Its application or use, however, is solely the responsibility of the user. No responsibility for the use of this information is assumed by Sipex, and this information shall not explicitly or implicitly become part of the terms and conditions of any subsequent sales agreement with Sipex. Specifications are subject to change without prior notice. By the sale or transfer of this information, Sipex assumes no responsibility for any infringement of patents or other rights of third parties which may result from its use. No license or other proprietary rights are granted by implication or otherwise under any patent or patent rights of Sipex Corporation.

PAD	X	Y
EL1	556.5	179.0
EL2	556.2	-151.0
COIL	-19.5	-517.0
V _{SS}	-568.0	-517.0
HON	-549.0	-256.5
CAP2	-549.0	93.5
CAP1	-568.0	-516.5
V _{DD}	-349.0	517.0

NOTES:

1. Dimensions are in Microns unless otherwise noted.
2. Bonding pads are 125x125 typical
3. Outside dimensions are maximum, including scribe area.
4. Die thickness is 10 mils +/- 1.
5. Pad center coordinates are relative to die center.
6. Die size 1447 x 1346 (57 x 53 mils).

PIN DESCRIPTION

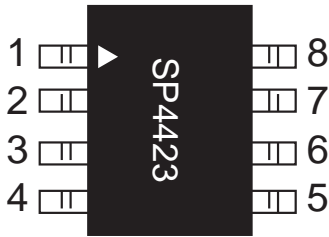

Pin 1 – HON- Enable for driver operation, high = active; low = inactive.

Pin 2 – V_{SS} - Power supply common, connect to ground.

Pin 3 – Coil- Coil input, connect coil from V_{DD} to pin 3.

Pin 4 – Lamp- Lamp driver output2, connect to EL lamp.

Pin 5 – Lamp- Lamp driver output1, connect to EL lamp.

Pin 6 – V_{DD} - Power supply for driver, connect to system V_{DD} .

Pin 7 – Cap1- Capacitor input 1, connect to C_{OSC} .

Pin 8 – Cap2- Capacitor input 2, connect to C_{OSC} .

THEORY OF OPERATION

The **SP4423** is made up of three basic circuit elements, an oscillator, coil, and switched H-bridge network. The oscillator provides the device with an on-chip clock source used to control the charge and discharge phases for the coil and lamp. An external capacitor connected between pins 7 and 8 allows the user to vary the oscillator frequency from 32kHz to 400kHz. The graphs on page 6 show the relationship between C_{OSC} and lamp output voltage. In general, increasing the C_{OSC} capacitor will increase the lamp output voltage and decrease the lamp frequency.

The suggested oscillator frequency is 64kHz ($C_{OSC}=150\text{pF}$). The oscillator output is internally divided to create two internal control signals, f_{COIL} and f_{LAMP} . The oscillator output is internally divided down by 8 flip flops; a 64kHz signal will be divided into 8 frequencies; 32, 16, 8, 4, 2, 1, 0.5, and 0.25 Hz. The 3rd flip flop output (8kHz) is used to drive the coil (see **Figure 2** on **page 9**) and the 8th flip flop output (250Hz) is used to drive the lamp. Although the oscillator frequency can be varied to optimize the lamp output, the ratio of f_{COIL}/f_{LAMP} will always equal 32.

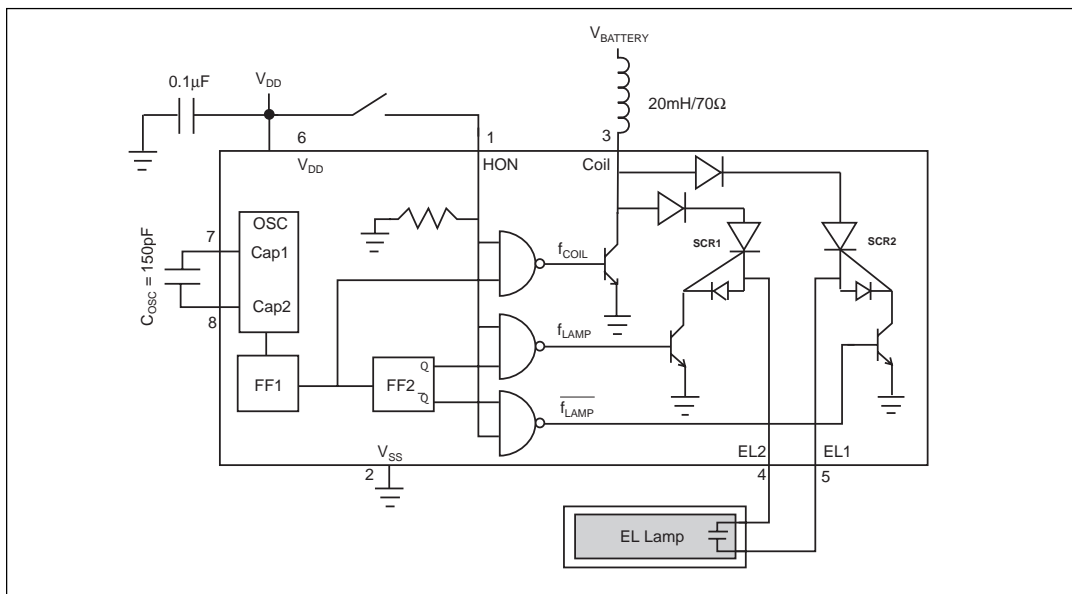

SP4423 Schematic

The on-chip oscillator of the **SP4423** can be overdriven with an external clock source by removing the C_{OSC} capacitor and connecting a clock source to pin 8 (Cap 2). The clock should have a 50% duty cycle and range from $V_{DD} - 1V$ to ground. An external clock signal may be desirable in order to synchronize any parasitic switching noise with the system clock. The maximum external clock frequencies that can be supplied is 400kHz.

The coil is an external component connected from $V_{BATTERY}$ to pin 3 of the **SP4423**. Energy is stored in the coil according to the equation $E_L = 1/2LI^2$, where I is the peak current flowing in the inductor. The current in the inductor is time dependent and is set by the "ON" time of the coil switch: $I = (V_L/L)t_{ON}$, where V_L is the voltage across the inductor. At the moment the switch closes, the current in the inductor is zero and the entire supply voltage (minus the V_{SAT} of the switch) is across the inductor. The current in the inductor will then ramp up at a linear rate. As the current in the inductor builds up, the voltage across the inductor will decrease due to the resistance of the coil and the "ON" resistance of the switch: $V_L = V_{BATTERY} - I R_L - V_{SAT}$. Since the voltage across the inductor is decreasing, the current ramp-rate also decreases which reduces the current in the coil at the end of t_{ON} , the energy stored in the inductor per coil cycle and therefore the light output. The other important issue is that maximum current (saturation current) in the coil is set by the design and manufacturer of the coil. If the parameters of the application such as $V_{BATTERY}$, L , RL or t_{ON} cause the current in the coil to increase beyond its rated I_{SAT} , excessive heat will be generated and the power efficiency will decrease with no additional light output. The **Sipex SP4423** is final tested using a 20mH/70Ω coil from CTC. For suggested coil sources see *page 10*.

The supply V_{DD} can range from 2.2 to 6.0V. It is not necessary that $V_{DD} = V_{BATTERY}$. $V_{BATTERY}$ should not exceed max coil current specification. The majority of the current goes through the coil and is typically much greater than I_{DD} .

The f_{COIL} signal controls a switch that connects the end of the coil at pin 3 to ground or to open circuit. The f_{COIL} signal is a 75% duty cycle signal, switching at 1/8 the oscillator frequency. For a 64kHz oscillator f_{COIL} is 8kHz. During the time when the f_{COIL} signal is high, the coil is

connected from $V_{BATTERY}$ to ground and a charged magnetic field is created in the coil. During the low part of f_{COIL} , the ground connection is switched open, the field collapses and the energy in the inductor is forced to flow toward the high voltage H-bridge switches. f_{COIL} will send 16 of these charge pulses to the lamp, each pulse increases the voltage drop across the lamp in discrete steps. As the voltage potential approaches its maximum, the steps become shorter (see *Figure 1* on *page 9*).

The H-bridge consists of two SCR structures that act as high voltage switches. These two switches control the polarity of how the lamp is charged. The SCR switches are controlled by the f_{LAMP} signal which is the oscillator frequency divided by 256. For a 64kHz oscillator, $f_{LAMP} = 250Hz$.

When the energy from the coil is released, a high voltage spike is created triggering the SCR switches. The direction of current flow is determined by which SCR is enabled. One full cycle of the H-bridge will create 16 voltage steps from ground to 80V (typical) on pins 4 and 5 which are 180 degrees out of phase with each other (see *Figure 3* on *page 9*). A differential representation of the outputs is shown in *Figure 4* on *page 9*. To minimize AC interference it is advisable to use a decoupling filter capacitor between V_{DD} and ground.

Electroluminescent Technology

What is electroluminescence?

An EL lamp is basically a strip of plastic that is coated with a phosphorous material which emits light (fluoresces) when a high voltage (>40V) which was first applied across it, is removed or reversed. Long periods of DC voltages applied to the material tend to breakdown the material and reduce its lifetime. With these considerations in mind, the ideal signal to drive an EL lamp is a high voltage sine wave. Traditional approaches to achieving this type of waveform included discrete circuits incorporating a transformer, transistors, and several resistors and capacitors. This approach is large and bulky, and cannot be implemented in most hand held equipment. **Sipex** now offers low power single chip driver circuits specifically designed to drive small to medium sized electroluminescent panels. All that is required is one external inductor and capacitor.

Electroluminescent backlighting is ideal when used with LCD displays, keypads, or other backlit readouts. Its main use is to illuminate displays in dim to dark conditions for momentary periods of time. EL lamps typically consume less than LEDs or incandescent bulbs making them ideal for battery powered products. Also, EL lamps are able to evenly light an area without creating "hot spots" in the display.

The amount of light emitted is a function of the voltage applied to the lamp, the frequency at which it is applied, the lamp material used and its size. There are many variables which can be optimized for specific applications. **Sipex** supplies characterization charts to aid the designer in selecting the optimum circuit configuration (see *page 6*).

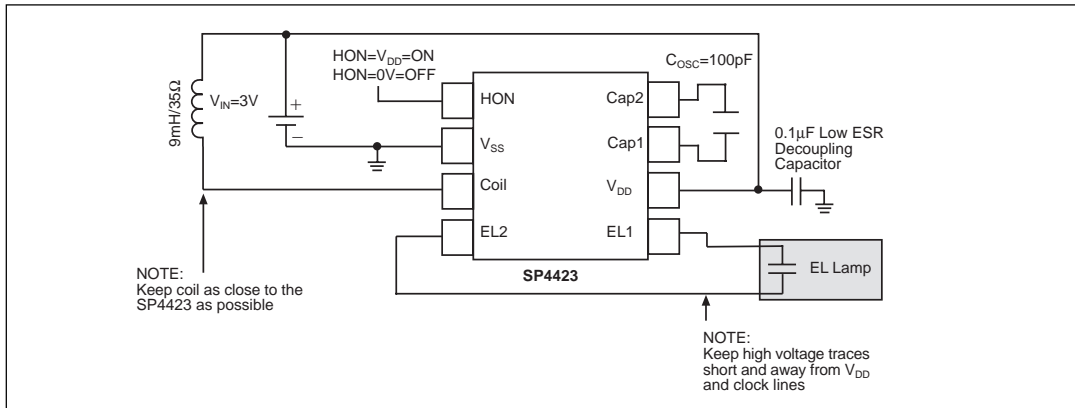

Typical SP4423 Application Circuit

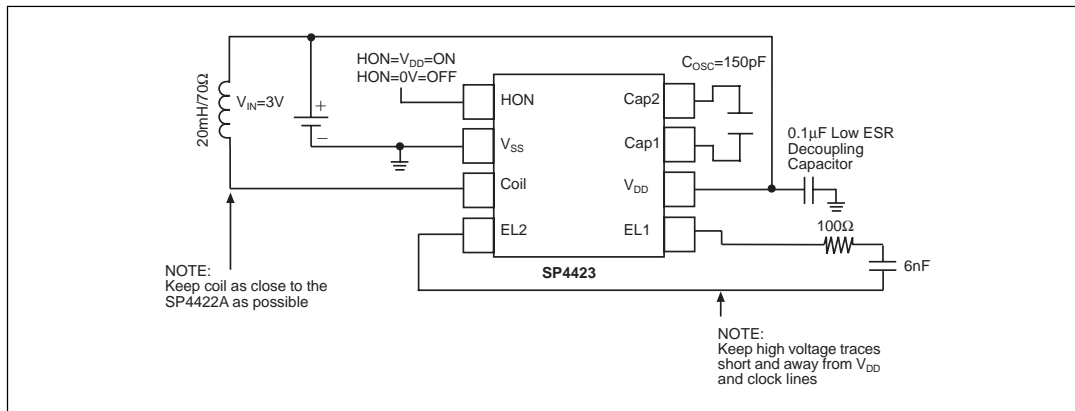

Typical SP4423 Test Circuit

The following performance curves are intended to give the designer a relative scale from which to optimize specific applications. Absolute measurements may vary depending upon the brand of components chosen.

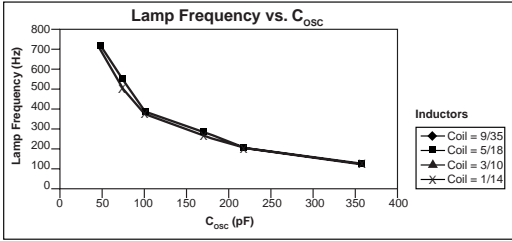

Lamp = 1sq. in., V_{DD} = 3.0V

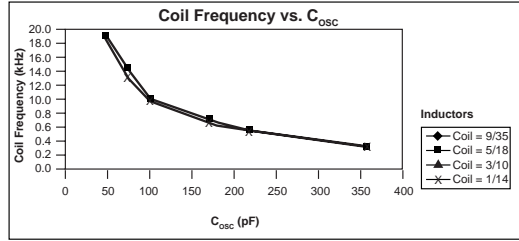

Lamp = 1sq. in., V_{DD} = 3.0V

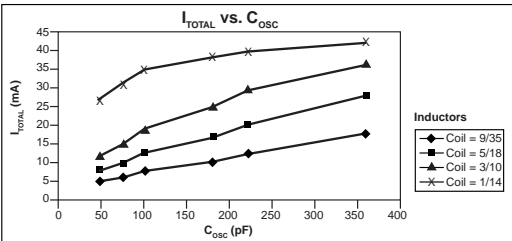

Lamp = 1sq. in., V_{DD} = 3.0V

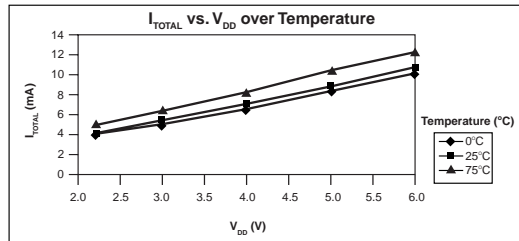

Coil = 20mH/70 ohms, C_{OSC} = 150pF

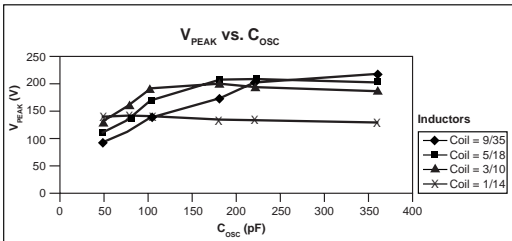

Lamp = 1sq. in., V_{DD} = 3.0V

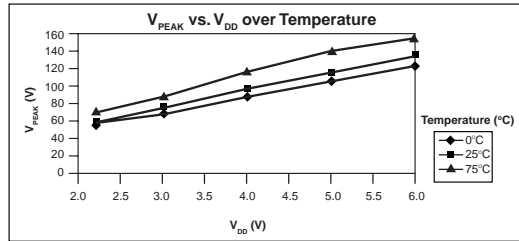

Coil = 20mH/70 ohms, C_{OSC} = 150pF

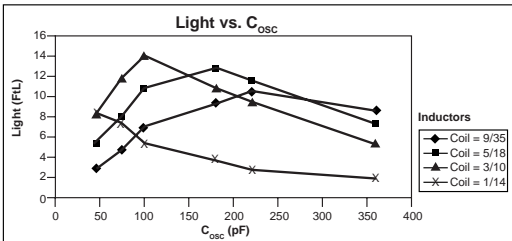

Lamp = 1sq. in., V_{DD} = 3.0V

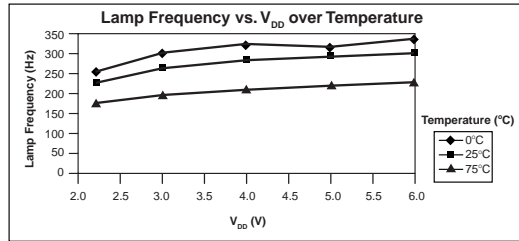

Coil = 20mH/70 ohms, C_{OSC} = 150pF

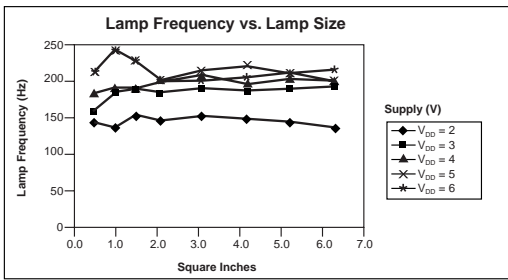

C_{OSC} = 220pF, Coil = 9mH/35 ohms

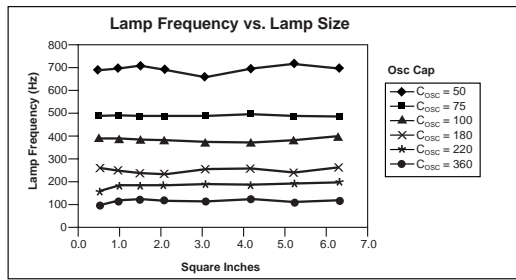

V_{DD} = 3.0V, Coil = 9mH/35 ohms

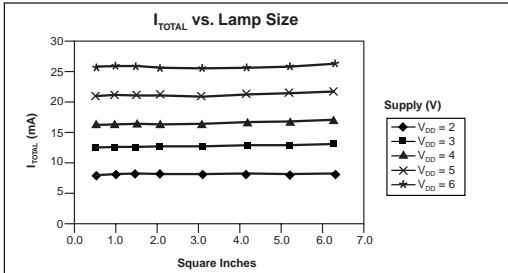

C_{OSC} = 220pF, Coil = 9mH/35 ohms

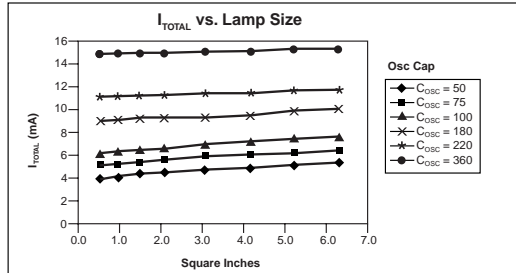

V_{DD} = 3.0V, Coil = 9mH/35 ohms

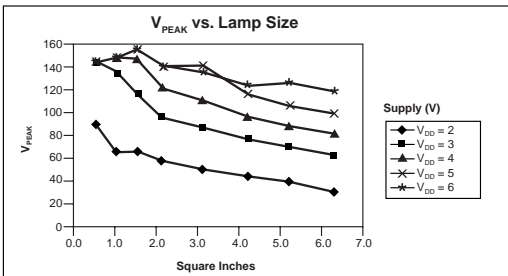

C_{OSC} = 220pF, Coil = 9mH/35 ohms

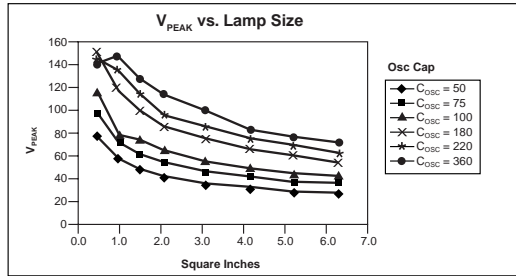

V_{DD} = 3.0V, Coil = 9mH/35 ohms

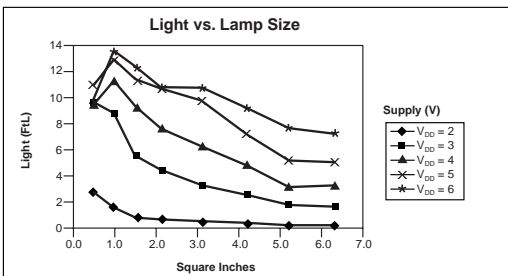

C_{OSC} = 220pF, Coil = 9mH/35 ohms

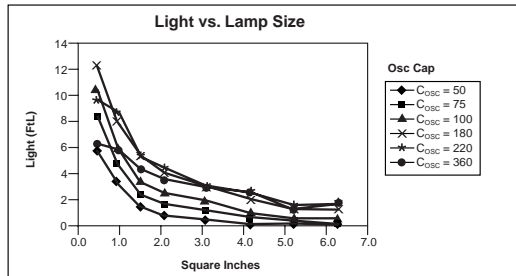

V_{DD} = 3.0V, Coil = 9mH/35 ohms

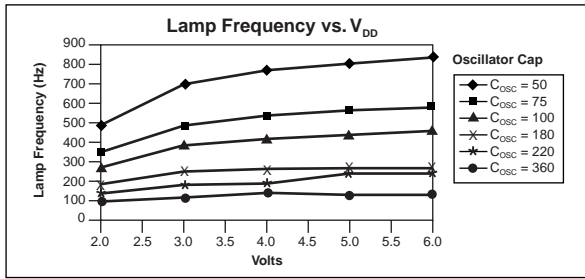

Lamp = 1sq. in., Coil = 9mH/35 ohms

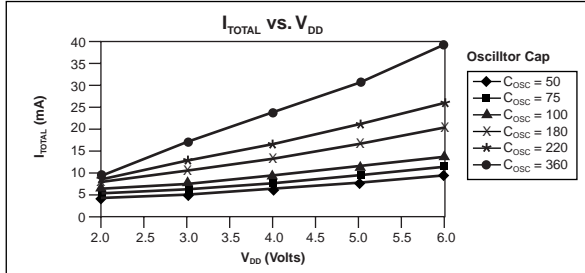

Lamp = 1sq. in., Coil = 9mH/35 ohms

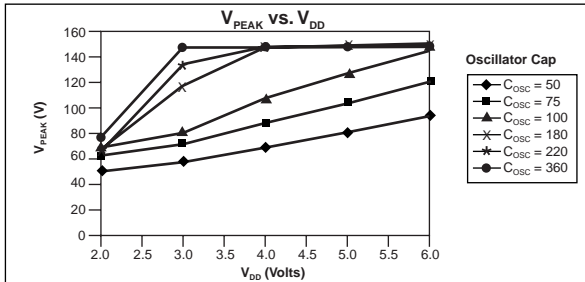

Lamp = 1sq. in., Coil = 9mH/35 ohms

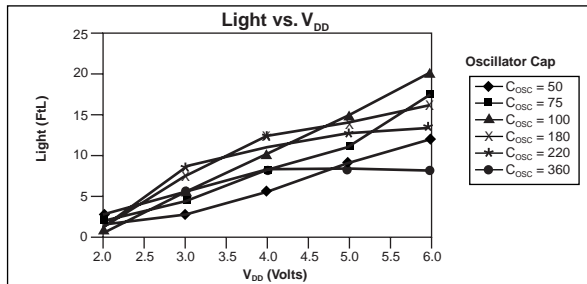

Lamp = 1sq. in., Coil = 9mH/35 ohms

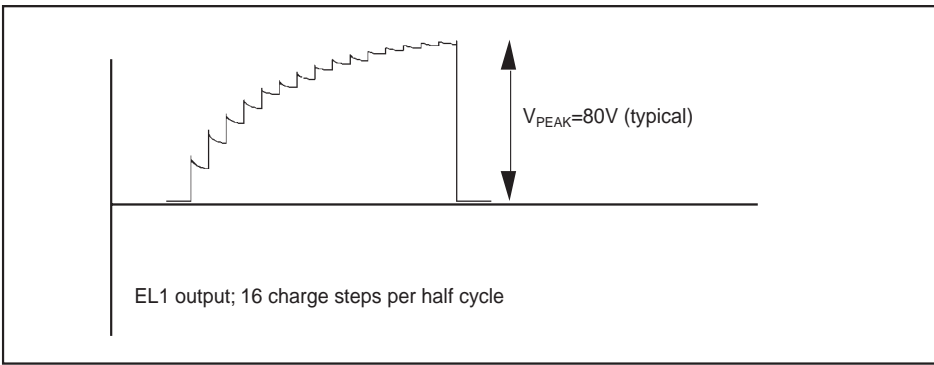

Figure 1. EL output voltage in discrete steps at EL1 output

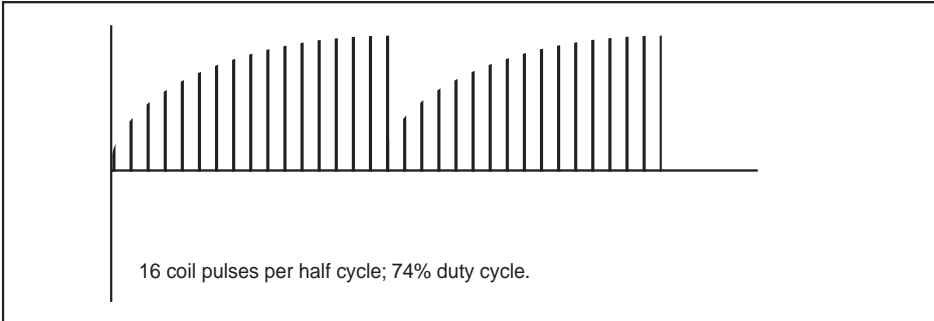

Figure 2. Voltage pulses released from the coil to the EL driver circuitry

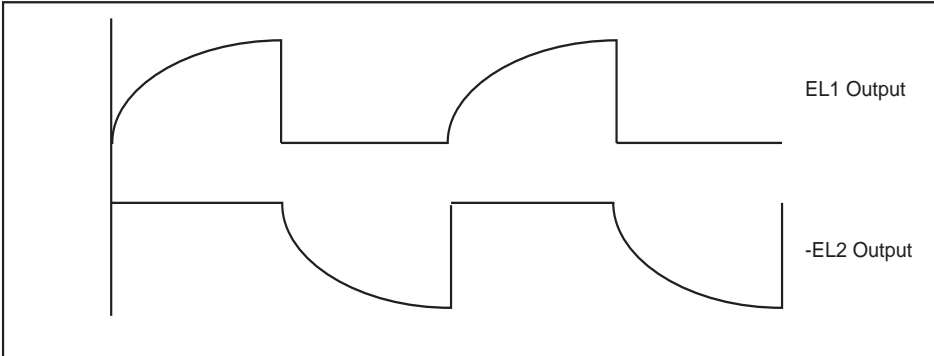

Figure 3. EL voltage waveforms from the EL1 and EL2 outputs

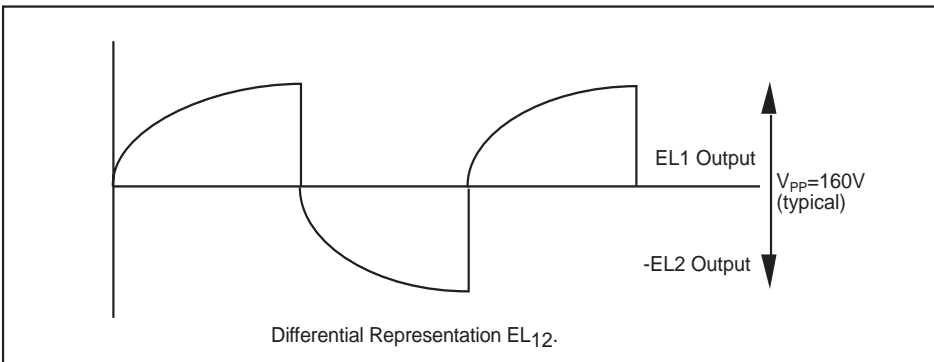

Figure 4. EL differential output waveform of the EL1 and EL2 outputs

The coil part numbers presented in this data sheet have been qualified as being suitable for the SP4422A product. Contact Sipex for applications assistance in choosing coil values not listed in this data sheet.

CTC Coils LTD Hong Kong

Ph: 85-2695-4889
 Fax: 85-2695-1842

Mark Technologies:
 North American Stocking
 distributor for Sankyo and CTC
 Ph: 905-891-0165
 Fax: 905-891-8534

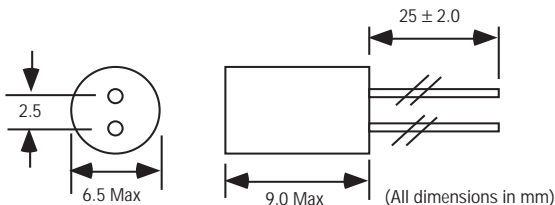

Model Numbers: CH5070AS-203K-006 (20mH, 65Ω)
 Sipex Number: S51208-M-1021-Sipex

HITACHI METALS Ltd. Japan
 Ph: 3-3284-4936
 Fax: 3-3287-1945

HITACHI METALS Hong Kong
 Ph: 852-2724-4183
 Fax: 852-2311-2093

HITACHI METALS Singapore
 Ph: 65-222-3077
 Fax: 65-222-5232

HITACHI METALS Chicago, IL
 Ph: 847-364-7200
 Fax: 847-364-7279

Part Numbers:
 MD735L902B (9mH + 20% 41Ω)
 MD735L502A (5mH ± 20% 19.8Ω)

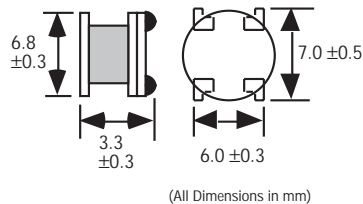

Toko Inc. Japan
 Ph: 03-3727-1161
 Fax: 03-3727-1176

Toko Inc. Singapore
 Ph: 255-4000
 Fax: 250-8134

Toko Korea
 Ph: 0551-50-5500
 Fax: 0551-93-1110

Toko America Inc. USA
 Ph: 847-297-0070
 Fax: 847-699-7864

Toko Germany
 Ph: 49-7156-96-060
 Fax: 49-7156-96-06-26

Toko France
 Ph: 01-4557-4465
 Fax: 01-4554-2837

Part Numbers:
 667MA-472N (4.7mH, 13Ω)

Toko U.K.
 Ph: 1753-854057-9
 Fax: 1753-8503-23

Toko Hong Kong
 Ph: 2342-8131
 Fax: 2341-9570

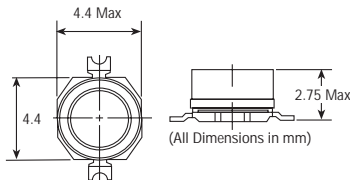

muRata USA
 Ph: 770-436-1300
 Fax: 770-436-3030

muRata Taiwan
 Ph: 88-6429-1415-1
 Fax: 88-6442-5292-9

muRata Hong Kong
 Ph: 85-2237-6389-8
 Fax: 85-2237-5556-55

muRata Europe
 Ph: 49-9116-6870
 Fax: 49-1166-8722-5

muRata Singapore
 Ph: 65-758-4233
 Fax: 65-753-6181

Part Numbers:
 LQN6C472M04 (4.7mH, 35Ω)
 LQN6C103M04 (10mH, 80Ω)

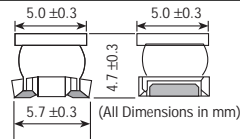

Coilcraft USA
 Ph: 847-639-6400
 Fax: 847-639-1469

Coilcraft Taiwan
 Ph: 886-2-264-3646
 Fax: 886-2-270-0294

Coilcraft Hong Kong
 Ph: 852-770-9428
 Fax: 852-770-0729

Coilcraft Europe
 Ph: 44-01236-730595
 Fax: 44-01236-730627

Coilcraft Singapore
 Ph: 65-296-6933
 Fax: 465-296-4463 #382

Part Numbers:
 DS1608C-106 (10mH, 32Ω)

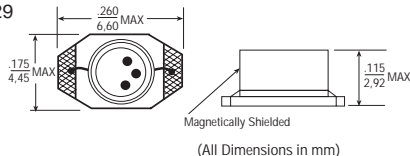

EL polarizers/transflector manufacturers

Nitto Denko
San Jose, CA
Phone: (510) 445-5400

Astra Products
Baldwin, NJ
Phone: (516) 223-7500
Fax: (516) 868-2371

EL Lamp manufacturers

Metro Mark/Leading Edge
Minnetonka, MN
Phone: (800) 680-5556
Phone: (612) 912-1700

Midori Mark Ltd.
1-5 Komagata 2-Chome
Taita-Ku 111-0043 Japan
Phone: 81-03-3848-2011

Luminescent Systems Inc. (LSI)
Lebanon, NH
Phone: (603) 643-7766
Fax: (603) 643-5947

NEC Corporation
Tokyo, Japan
Phone: (03) 3798-9572
Fax: (03) 3798-6134

Seiko Precision
Tokyo, Japan
Phone: (03) 5610-7089
Fax: .) 5610-7177

Gunze Electronics
2113 Wells Branch Parkway
Austin, TX 78728
Phone: (512) 752-1299
Fax: (512) 252-1181

All package dimensions in inches

8-pin NSOIC

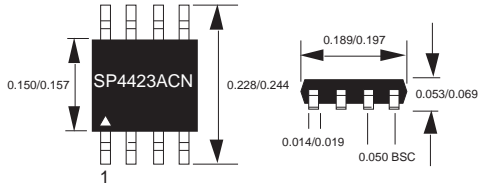

8-pin μ SOIC

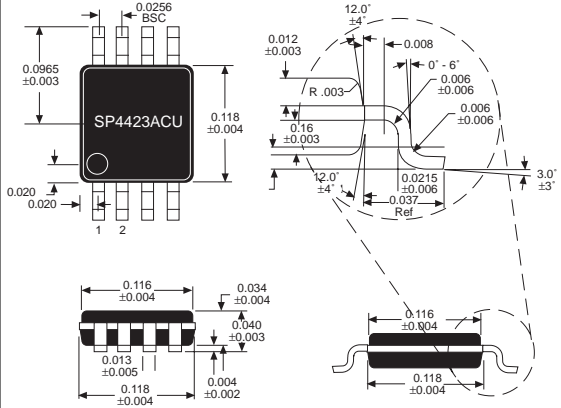

95 SP4423ACN per tube, no minimum quantity



50 SP4423ACU per tube

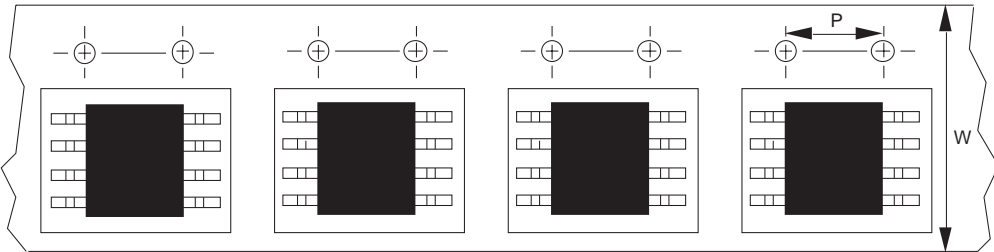

NSOIC-8 13" reels: P=8mm, W=12mm
 μ SOIC-8 13" reels: P=8mm, W=12mm

Pkg.	Minimum qty per reel	Standard qty per reel	Maximum qty per reel
ACN	500	2500	3000
ACU	500	2500	3000

ORDERING INFORMATION

Model	Temperature Range	Package Type
SP4423CN	0°C to +70°C	8-Pin NSOIC
SP4423CU	0°C to +70°C	8-Pin μ SOIC
SP4423CX	0°C to +70°C	Die
SP4423NEB		NSOIC Evaluation Board
SP4423UEB		μ SOIC Evaluation Board

Please consult the factory for pricing and availability on a Tape-On-Reel option.



SIGNAL PROCESSING EXCELLENCE

Sipex Corporation

Headquarters and Sales Office

22 Linnell Circle
Billerica, MA 01821
TEL: (978) 667-8700
FAX: (978) 670-9001
e-mail: sales@sipex.com

Sales Office

233 South Hillview Drive
Milpitas, CA 95035
TEL: (408) 934-7500
FAX: (408) 935-7600

Sipex Corporation reserves the right to make changes to any products described herein. Sipex does not assume any liability arising out of the application or use of any product or circuit described hereing; neither does it convey any license under its patent rights nor the rights of others.

Copyright © Each Manufacturing Company.

All Datasheets cannot be modified without permission.

This datasheet has been download from :

www.AllDataSheet.com

100% Free DataSheet Search Site.

Free Download.

No Register.

Fast Search System.

www.AllDataSheet.com