

Ultra-Fast-Recovery Rectifier Diodes (Power Surface Mount)

Parameter Type No.	Absolute Maximum Ratings					Electrical Characteristics (Ta=25°C)							Others		
	VRM (V)	IF(AV) (A)	IFSM (A) 50Hz Half-cycle Sinewave Single Shot	TJ (°C)	Tstg (°C)	VF (V)		IR (μA) VR=VRM max per element	IR (H) (mA) VR=VRM, Ta=100°C max per element	trr(1) (ns)		trr(2) (ns)		Rth (j-c) (°C/W)	Mass (g)
						max per element	IF (A)			IF/IRP (mA)	IF/IRP (mA)				
SPX-G32S	200	3.0	50	-40 to +150	0.98	3.0	50	10	30	100/100	25	100/200	5.0	0.41	Ⓐ
SPX-62S		6.0	80												

SPX-G32S

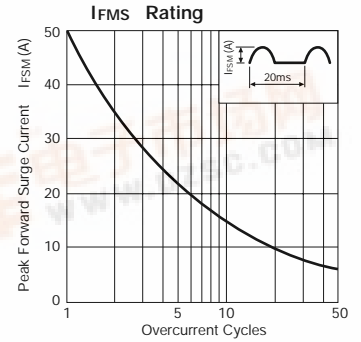
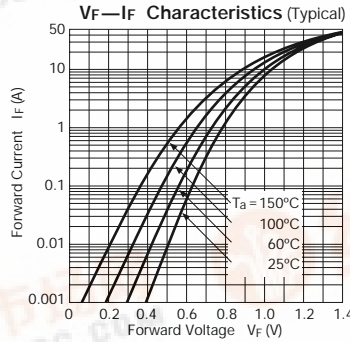
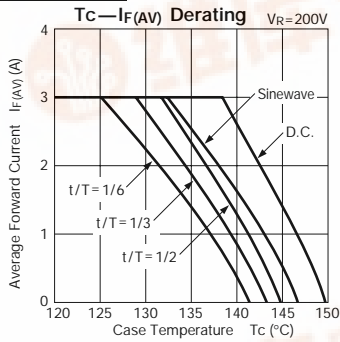

SPX-62S

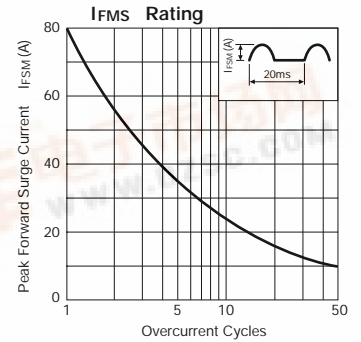
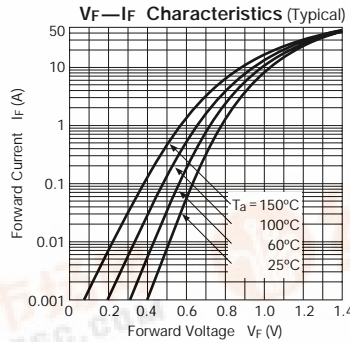
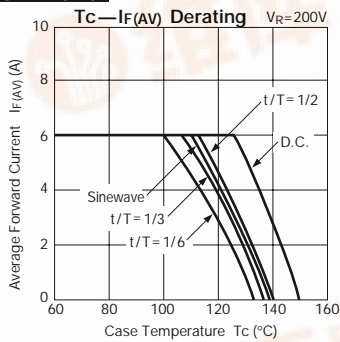

External Dimensions (Unit: mm)

Flammability:
UL94V-0 or Equivalent

Fig. (A)

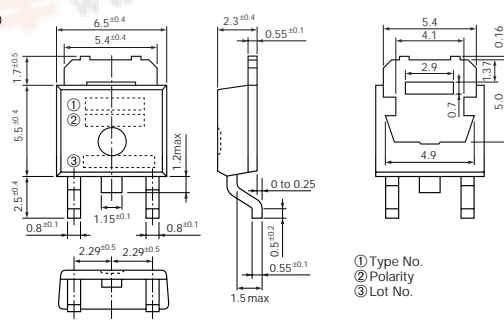

- ① Type No.
- ② Polarity
- ③ Lot No.

	1	2 (Common to backside of case)	3
SPX-G32S	N.C	Cathode	Anode
SPX-62S	Anode	Cathode (Common)	Anode

