



Micro Commercial Components  
21201 Itasca Street Chatsworth  
CA 91311  
Phone: (818) 701-4933  
Fax: (818) 701-4939

# SS22 THRU SS210

## Features

- Schottky Barrier Rectifier
- Guard Ring Protection
- Low Forward Voltage
- Reverse Energy Tested
- High Current Capability
- Extremely Low Thermal Resistance

## 2 Amp Schottky Rectifier 20 to 100 Volts

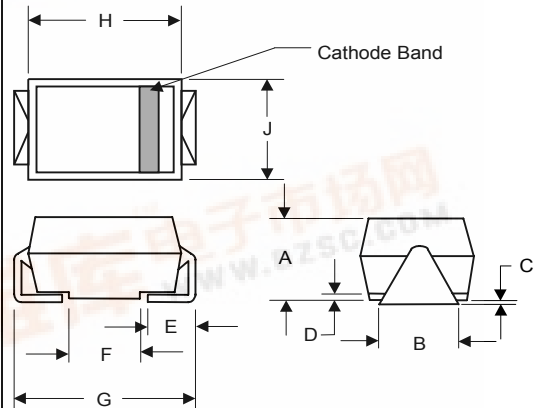
## Maximum Ratings

- Operating Temperature: -55°C to +125°C
- Storage Temperature: -55°C to +150°C
- Maximum Thermal Resistance; 15°C/W Junction To Lead

## DO-214AC

### (SMAJ) (High Profile)

MCC Catalog Number	Device Marking	Maximum Recurrent Peak Reverse Voltage	Maximum RMS Voltage	Maximum DC Blocking Voltage
SS22	SS22	20V	14V	20V
SS23	SS23	30V	21V	30V
SS24	SS24	40V	28V	40V
SS25	SS25	50V	35V	50V
SS26	SS26	60V	42V	60V
SS28	SS28	80V	56V	80V
SS210	SS210	100V	70V	100V

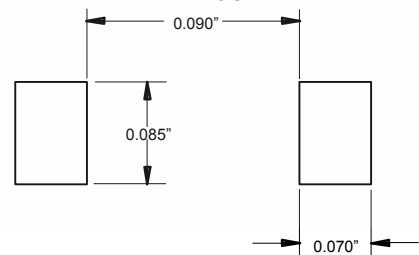


## Electrical Characteristics @ 25°C Unless Otherwise Specified

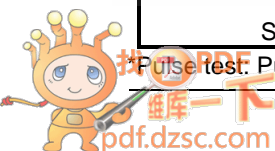
DIM	INCHES		MM		NOTE
	MIN	MAX	MIN	MAX	
A	.078	.116	1.98	2.95	
B	.067	.089	1.70	2.25	
C	.002	.008	.05	.20	
D	---	.02	---	.51	
E	.035	.055	.89	1.40	
F	.065	.096	1.65	2.45	
G	.205	.224	5.21	5.69	
H	.160	.180	4.06	4.57	
J	.100	.112	2.57	2.84	

Average Forward Current	$I_{F(AV)}$	2.0A	$T_J = 100^\circ\text{C}$
Peak Forward Surge Current	$I_{FSM}$	50A	8.3ms, half sine
Maximum Instantaneous Forward Voltage SS22-SS24 SS25-SS26 SS28-SS210	$V_F$	.55V .70V .85V	$I_{FM} = 2.0\text{A};$ $T_J = 25^\circ\text{C}^*$
Maximum DC Reverse Current At Rated DC Blocking Voltage	$I_R$	0.5mA	$T_J = 25^\circ\text{C}$
Typical Junction Capacitance SS22 SS23-SS210	$C_J$	230pF 50pF	Measured at 1.0MHz, $V_R=4.0\text{V}$

### SUGGESTED SOLDER PAD LAYOUT



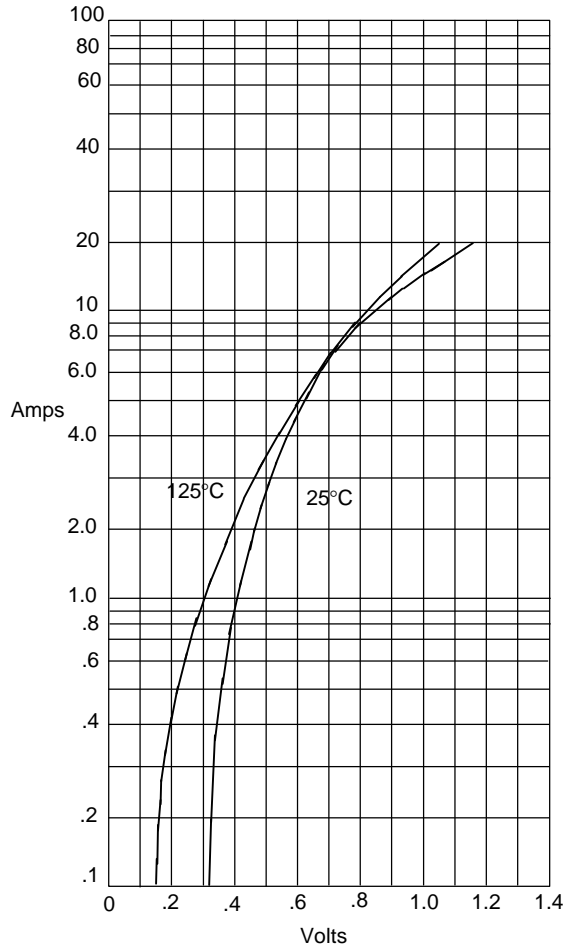
\*Pulse test. Pulse width 300 μsec, Duty cycle 2%



# SS22

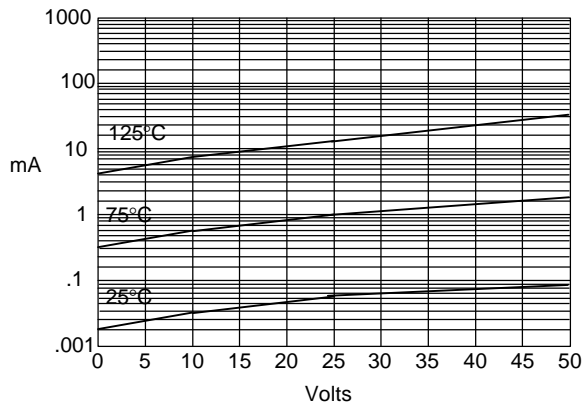


Figure 1  
Typical Forward Characteristics



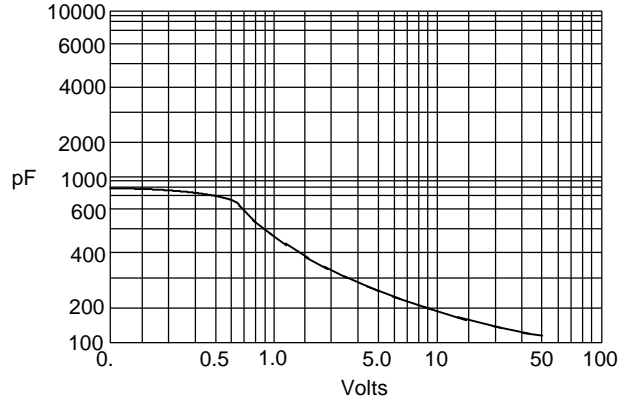
Instantaneous Forward Current - Amperes versus  
Instantaneous Forward Voltage - Volts

Figure 2  
Typical Reverse Characteristics



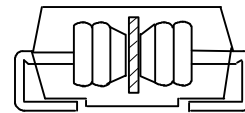
Typical Reverse Current - mA versus  
Reverse Voltage - Volts

Figure 3  
Typical Junction Capacitance



Junction Capacitance - pF versus  
Reverse Voltage - Volts

Figure 4  
New SMA Assembly

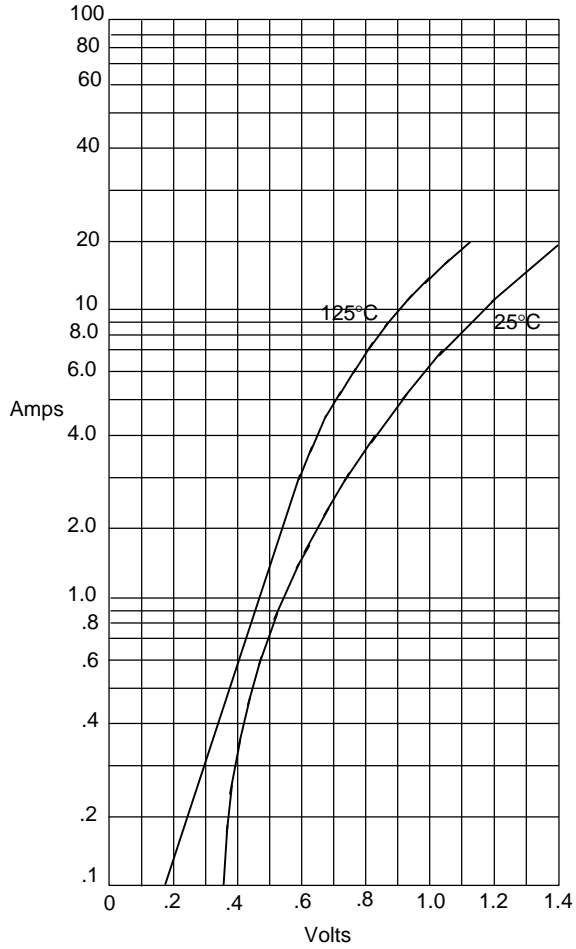


Round Lead  
Process

# SS23 thru SS210

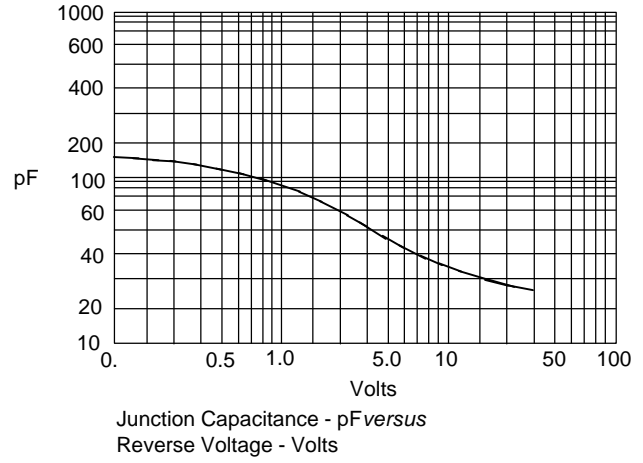


Figure 1  
Typical Forward Characteristics



Instantaneous Forward Current - Amperes versus  
Instantaneous Forward Voltage - Volts

Figure 3  
Typical Junction Capacitance



Junction Capacitance - pF versus  
Reverse Voltage - Volts

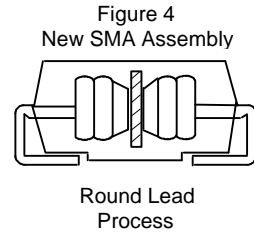
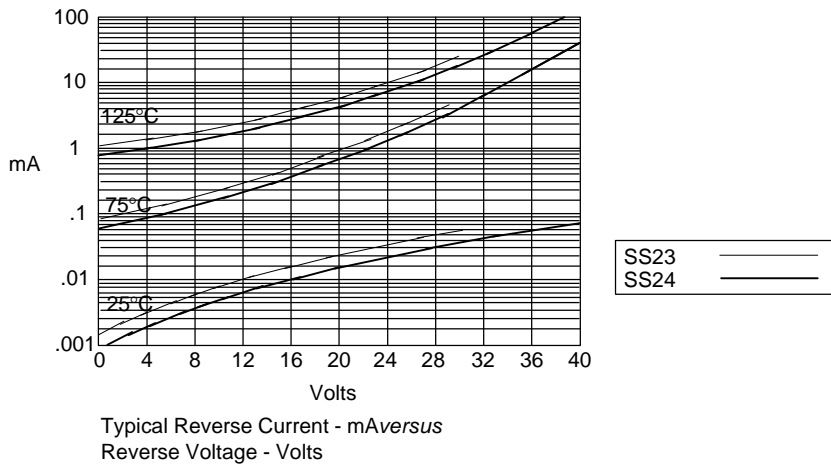


Figure 2  
Typical Reverse Characteristics



Typical Reverse Current - mA versus  
Reverse Voltage - Volts