

Bulletin I25202 rev. A 01/00

International IOR Rectifier

ST1000C..K SERIES

PHASE CONTROL THYRISTORS

Hockey Puk Version

Features

- Center amplifying gate
- Metal case with ceramic insulator
- International standard case A-24 (K-PUK)
- High profile hockey-puk

Typical Applications

- DC motor controls
- Controlled DC power supplies
- AC controllers

1473A

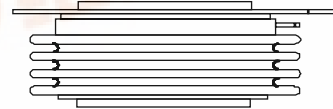

case style A-24 (K-PUK)

Major Ratings and Characteristics

Parameters	ST1000C..K	Units
$I_{T(AV)}$	1473	A
	@ T_{hs} 55	°C
$I_{T(RMS)}$	2913	A
	@ T_{hs} 25	°C
I_{TSM}	@ 50Hz 20.0	KA
	@ 60Hz 21.2	KA
I^2t	@ 50Hz 2000	KA ² s
	@ 60Hz 1865	KA ² s
$I^2\sqrt{t}$	20000	KA ² √s
V_{DRM}/V_{RRM} range	1200 to 2600	V
t_q typical	300	μs
T_J range	-40 to 125	°C

ST1000C..K Series

Bulletin I25202 rev. A 01/00

International
IRF Rectifier

ELECTRICAL SPECIFICATIONS

Voltage Ratings

Type number	Voltage Code	V_{RRM} , maximum repetitive peak reverse voltage V	V_{RSM} , maximum non-repetitive peak rev. voltage V	I_{RRM} max. @ $T_J = 125^\circ\text{C}$ mA
ST1000C..K	12	1200	1300	100
	16	1600	1700	
	20	2000	2100	
	22	2200	2300	
	24	2400	2500	
	26	2600	2700	

On-state Conduction

Parameter	ST1000C..K	Units	Conditions
$I_{T(AV)}$ Maximum average on-state current @ Heatsink temperature	1473 (630)	A	180° conduction, half sine wave
	55 (85)	°C	Double side (single side) cooled
$I_{T(RMS)}$ Maximum RMS on-state current	6540	A	DC @ 25°C heatsink temp. double side cooled
I_{TSM} Maximum peak, one-cycle, non-repetitive surge current	20.0	KA	t = 10ms No voltage
	21.2		t = 8.3ms reapplied
	17.0		t = 10ms 100% V_{RRM}
	18.1		t = 8.3ms reapplied
I^2t Maximum I^2t for fusing	2000	KA ² s	t = 10ms No voltage
	1865		t = 8.3ms reapplied
	1445		t = 10ms 100% V_{RRM}
	1360		t = 8.3ms reapplied
$I^2\sqrt{t}$ Maximum $I^2\sqrt{t}$ for fusing	20000	KA ² √s	t = 0.1 to 10ms, no voltage reapplied
$V_{T(TO)1}$ Low level value of threshold voltage	0.950	V	$(16.7\% \times \pi \times I_{T(AV)} < I < \pi \times I_{T(AV)})$, $T_J = T_J$ max.
$V_{T(TO)2}$ High level value of threshold voltage	1.024		$(I > \pi \times I_{T(AV)})$, $T_J = T_J$ max.
r_{t1} Low level value of on-state slope resistance	0.283	mΩ	$(16.7\% \times \pi \times I_{T(AV)} < I < \pi \times I_{T(AV)})$, $T_J = T_J$ max.
r_{t2} High level value of on-state slope resistance	0.265		$(I > \pi \times I_{T(AV)})$, $T_J = T_J$ max.
V_{TM} Maximum on-state voltage drop	1.80	V	$I_{pk} = 3000\text{A}$, $T_J = 125^\circ\text{C}$, $t_p = 10\text{ms}$ sine pulse
I_H Maximum holding current	600	mA	$T_J = 25^\circ\text{C}$, anode supply 12V resistive load
I_L Typical latching current	1000		

Switching

Parameter	ST1000C..K	Units	Conditions
di/dt Maximum non repetitive rate of rise of turned-on current	1000	A/μs	Gate drive 20V, 20Ω, $t_r \leq 1\mu s$ $T_J = T_J \text{ max.}$, anode voltage $\leq 80\% V_{DRM}$
t_d Typical delay time	1.9	μs	Gate current 1A, $di_g/dt = 1A/\mu s$ $V_d = 0.67\% V_{DRM}$, $T_J = 25^\circ C$
t_q Typical turn-off time	300	A/μs	$I_{TM} = 550A$, $T_J = T_J \text{ max.}$, $di/dt = 40A/\mu s$, $V_R = 50V$ $dv/dt = 20V/\mu s$, Gate 0V 100Ω, $t_p \leq 500\mu s$

Blocking

Parameter	ST1000C..K	Units	Conditions
dv/dt Maximum critical rate of rise of off-state voltage	500	V/μs	$T_J = T_J \text{ max.}$, linear to 80% rated V_{DRM}
I_{RRM} I_{DRM} Maximum peak reverse and off-state leakage current	100	μs	$T_J = T_J \text{ max.}$, rated V_{DRM}/V_{RRM} applied

Triggering

Parameter	ST1000C..K		Units	Conditions
P_{GM} Maximum peak gate power	16		W	$T_J = T_J \text{ max.}$, $t_p \leq 5ms$
$P_{G(AV)}$ Maximum peak average gate power	3		W	$T_J = T_J \text{ max.}$, $f = 50Hz$, $d\% = 50$
I_{GM} Maximum peak positive gate current	3.0		A	$T_J = T_J \text{ max.}$, $t_p \leq 5ms$
+ V_{GM} Maximum peak positive gate voltage	20		V	
- V_{GM} Maximum peak negative gate voltage	5.0		V	
I_{GT} DC gate current required to trigger	TYP.	MAX.	mA	
	200	-		
	100	200		
	50	-		
V_{GT} DC gate voltage required to trigger	1.4	-	V	$T_J = -40^\circ C$ $T_J = 25^\circ C$ $T_J = 125^\circ C$
	1.1	3.0		
	0.9	-		
I_{GD} DC gate current not to trigger	10		mA	$T_J = T_J \text{ max.}$ Max. gate current / voltage not to trigger is the max. value which will not trigger any units with rated V_{DRM} anode-to-cathode applied
V_{GD} DC gate voltage not to trigger	0.25		V	

ST1000C..K Series

Bulletin I25202 rev. A 01/00

International
IOR Rectifier

Thermal and Mechanical Specifications

Parameter	ST1000C..K	Units	Conditions
T _J Max. junction operating temperature range	-40 to 125	°C	
T _{stg} Max. storage temperature range	-40 to 150		
R _{thJ-hs} Max. thermal resistance, junction to heatsink	0.042	K/W	DC operation single side cooled
	0.021		DC operation double side cooled
R _{thC-hs} Max. thermal resistance, case to heatsink	0.006	K/W	DC operation single side cooled
	0.003		DC operation double side cooled
F Mounting force, ± 10%	24500 (2500)	N (Kg)	
wt Approximate weight	425	g	
Case style	A-24 (K-PUK)		See outline table

ΔR_{thJC} Conduction

(The following table shows the increment of thermal resistance R_{thJC} when devices operate at different conduction angles than DC)

Conduction angle	Sinusoidal conduction		Rectangular conduction		Units	Conditions
	Single Side	Double Side	Single Side	Double Side		
180°	0.003	0.003	0.002	0.002	K/W	T _J = T _J max.
120°	0.004	0.004	0.004	0.004		
90°	0.005	0.005	0.005	0.005		
60°	0.007	0.007	0.007	0.007		
30°	0.012	0.012	0.012	0.012		

Ordering Information Table

Device Code							
ST	100	0	C	26	K	1	
①	②	③	④	⑤	⑥	⑦	⑧
1	- Thyristor						
2	- Essential part number						
3	- 0 = Converter grade						
4	- C = Ceramic Puk						
5	- Voltage code: Code x 100 = V _{RRM} (See Voltage Ratings Table)						
6	- K = Puk Case A-24 (K-PUK)						
7	- 0 = Eyelet terminals (Gate and Auxiliary Cathode Unsoldered Leads)						
	1 = Fast-on terminals (Gate and Auxiliary Cathode Unsoldered Leads)						
	2 = Eyelet terminals (Gate and Auxiliary Cathode Soldered Leads)						
	3 = Fast-on terminals (Gate and Auxiliary Cathode Soldered Leads)						
8	- Critical dv/dt: None = 500V/μsec (Standard selection)						
	L = 1000V/μsec (Special selection)						

Outline Table

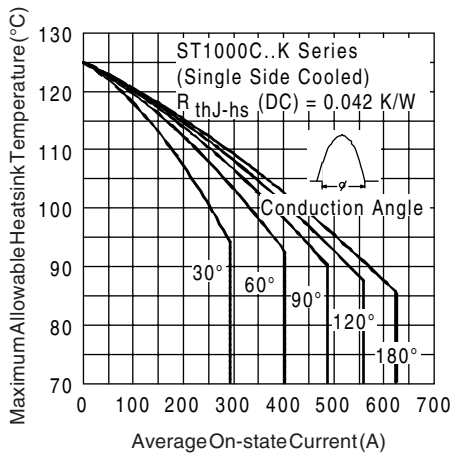
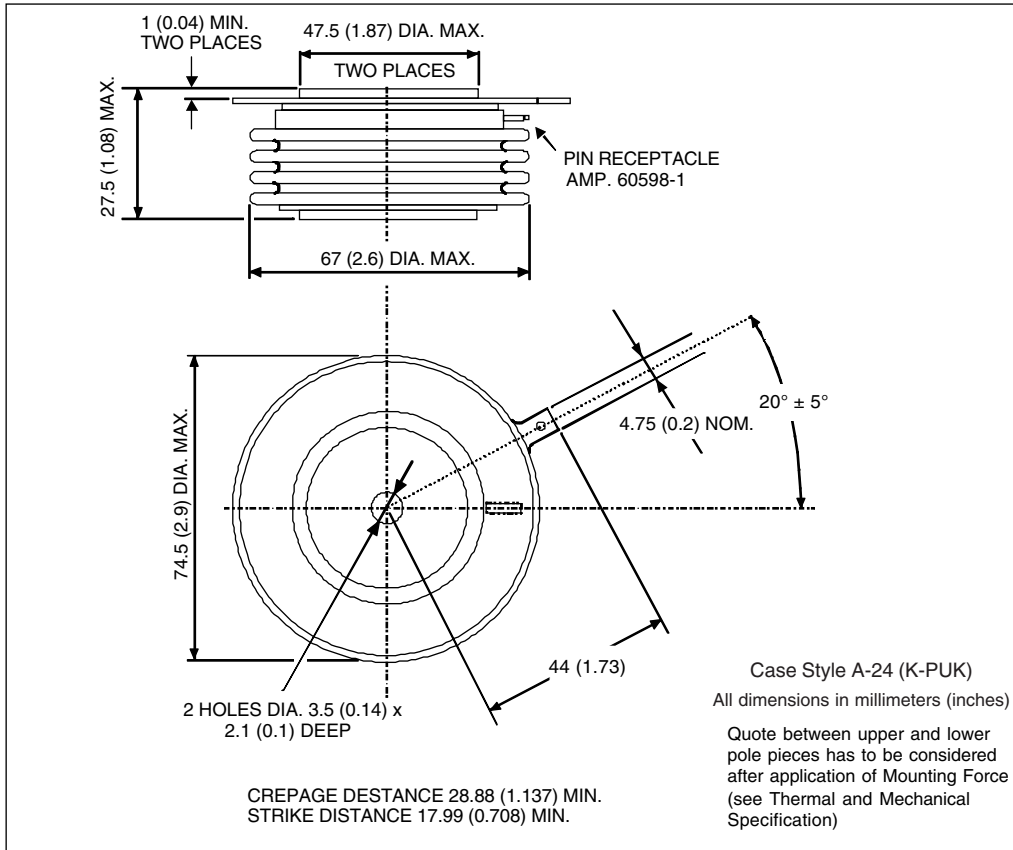

Fig. 1 - Current Ratings Characteristics

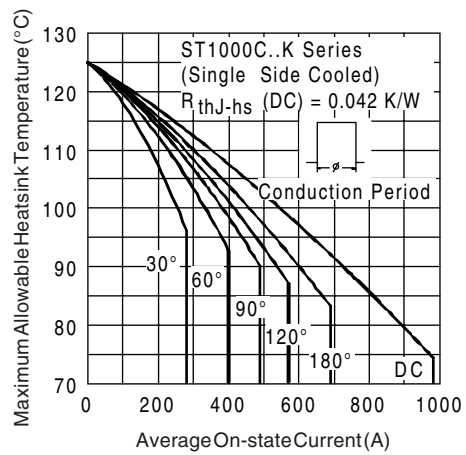

Fig. 2 - Current Ratings Characteristics

ST1000C..K Series

Bulletin I25202 rev. A 01/00

International
IRF Rectifier

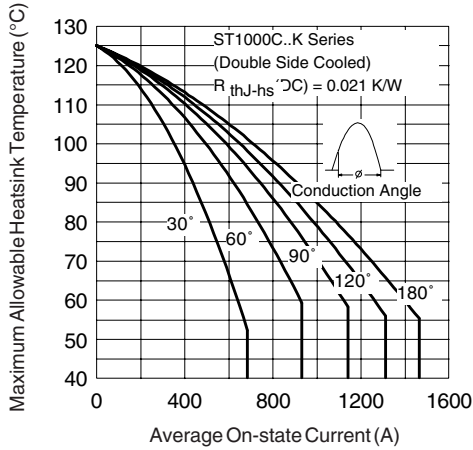

Fig. 3 - Current Ratings Characteristics

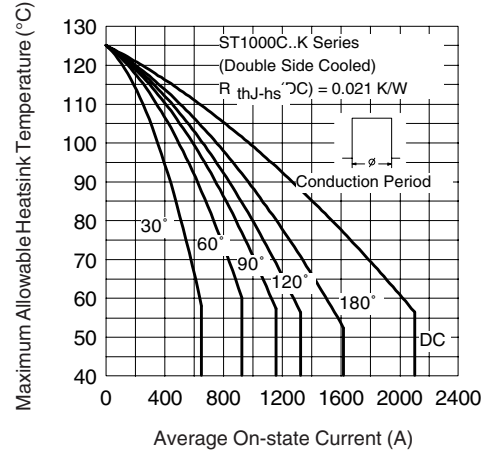

Fig. 4 - Current Ratings Characteristics

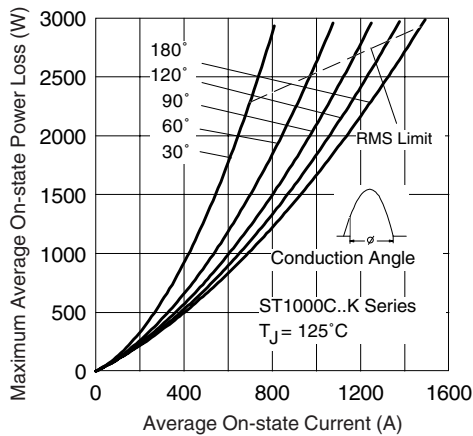

Fig. 5 - On-state Power Loss Characteristics

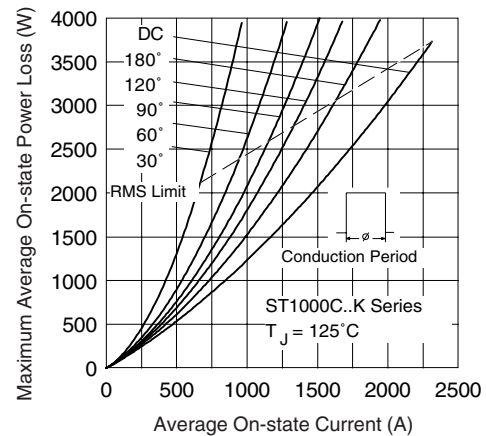

Fig. 6 - On-state Power Loss Characteristics

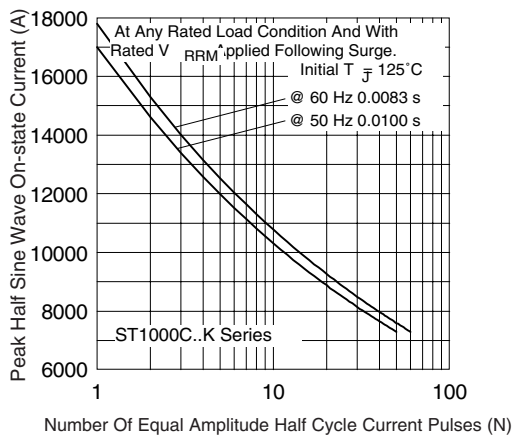

Fig. 7 - Maximum Non-Repetitive Surge Current Single and Double Side Cooled

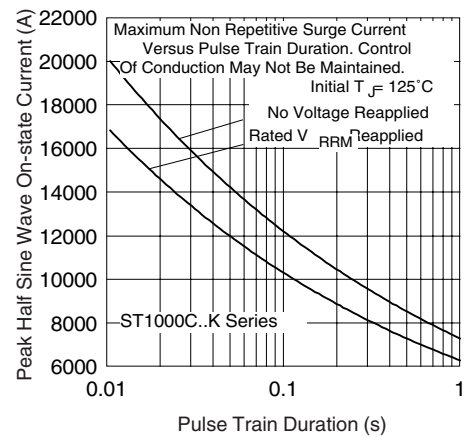

Fig. 8 - Maximum Non-Repetitive Surge Current Single and Double Side Cooled

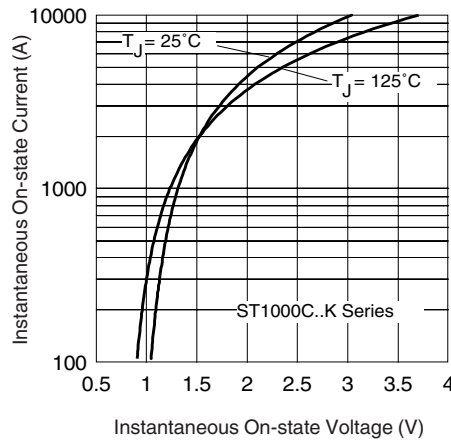

Fig. 9 - On-state Voltage Drop Characteristics

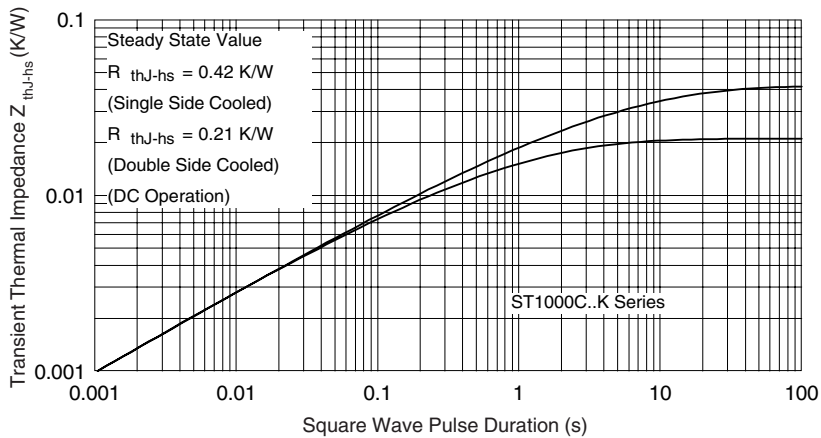

Fig. 10 - Thermal Impedance Z_{thJ-hs} Characteristics

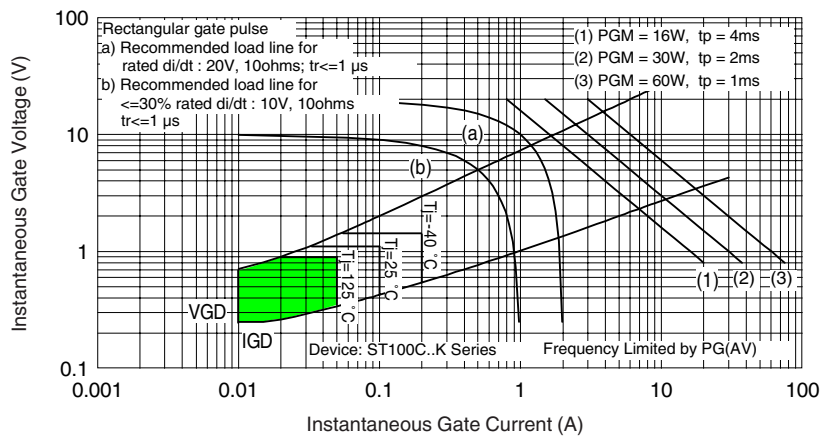

Fig. 11 - Gate Characteristics