



# ST13007

## HIGH VOLTAGE FAST-SWITCHING NPN POWER TRANSISTOR

- IMPROVED SPECIFICATION:
  - LOWER LEAKAGE CURRENT
  - TIGHTER GAIN RANGE
  - DC CURRENT GAIN PRESELECTION
  - TIGHTER STORAGE TIME RANGE
- HIGH VOLTAGE CAPABILITY
- NPN TRANSISTOR
- LOW SPREAD OF DYNAMIC PARAMETERS
- MINIMUM LOT-TO-LOT SPREAD FOR RELIABLE OPERATION
- VERY HIGH SWITCHING SPEED
- FULLY CHARACTERIZED AT 125 °C
- LARGE RBSOA

### APPLICATIONS

- ELECTRONIC BALLASTS FOR FLUORESCENT LIGHTING
- SWITCH MODE POWER SUPPLIES

### DESCRIPTION

The device is manufactured using high voltage Multi Epitaxial Planar technology for high switching speeds and high voltage capability.

They use a Cellular Emitter structure to enhance switching speeds.

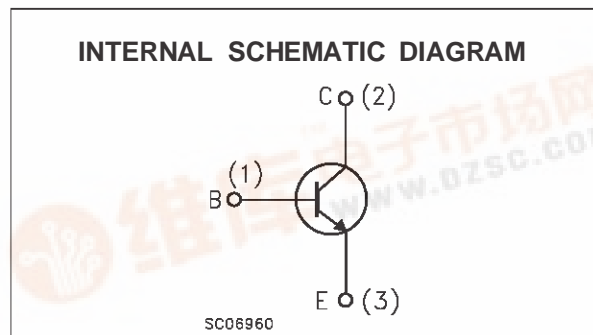
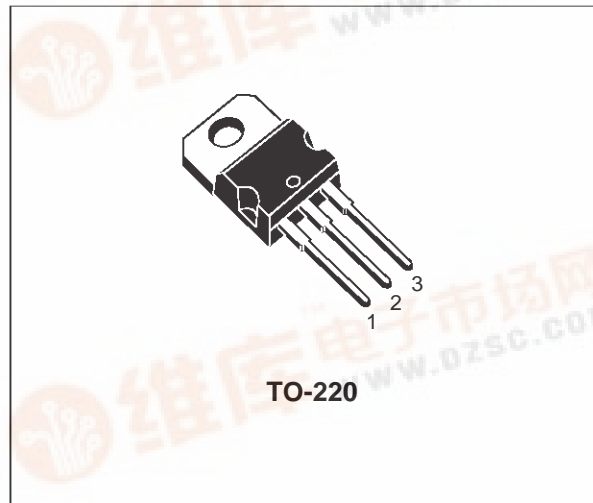

### ABSOLUTE MAXIMUM RATINGS

Symbol	Parameter	Value	Unit
$V_{CEV}$	Collector-Emitter Voltage ( $V_{BE} = -1.5V$ )	700	V
$V_{CEO}$	Collector-Emitter Voltage ( $I_B = 0$ )	400	V
$V_{EBO}$	Emitter-Base Voltage ( $I_C = 0$ )	9	V
$I_C$	Collector Current	8	A
$I_{CM}$	Collector Peak Current	16	A
$I_B$	Base Current	4	A
$I_{BM}$	Base Peak Current	8	A
$P_{tot}$	Total Dissipation at $T_c \leq 25\text{ }^\circ\text{C}$	80	W
$T_{stg}$	Storage Temperature	-65 to 150	$^\circ\text{C}$
$T_j$	Max. Operating Junction Temperature	150	$^\circ\text{C}$

# ST13007

## THERMAL DATA

$R_{thj-case}$	Thermal Resistance Junction-case	Max	1.56	$^{\circ}C/W$
----------------	----------------------------------	-----	------	---------------

## ELECTRICAL CHARACTERISTICS ( $T_{case} = 25^{\circ}C$ unless otherwise specified)

Symbol	Parameter	Test Conditions	Min.	Typ.	Max.	Unit
$I_{CEV}$	Collector Cut-off Current ( $V_{BE} = -1.5V$ )	$V_{CE} = \text{rated } V_{CEV}$ $V_{CE} = \text{rated } V_{CEV} \quad T_c = 100^{\circ}C$			10 0.5	$\mu A$ mA
$I_{EBO}$	Emitter Cut-off Current ( $I_C = 0$ )	$V_{EB} = 9V$			1	mA
$V_{CEO(sus)*}$	Collector-Emitter Sustaining Voltage	$I_C = 10mA$	400			V
$V_{CE(sat)*}$	Collector-Emitter Saturation Voltage	$I_C = 2A \quad I_B = 0.4A$ $I_C = 5A \quad I_B = 1A$ $I_C = 8A \quad I_B = 2A$ $I_C = 5A \quad I_B = 1A \quad T_c = 100^{\circ}C$			1 2 3 3	V V V V
$V_{BE(sat)*}$	Base-Emitter Saturation Voltage	$I_C = 2A \quad I_B = 0.4A$ $I_C = 5A \quad I_B = 1A$ $I_C = 5A \quad I_B = 1A \quad T_c = 100^{\circ}C$			1.2 1.6 1.5	V V V
$h_{FE*}$	DC Current Gain	$I_C = 2A \quad V_{CE} = 5V$ Group A Group B $I_C = 5A \quad V_{CE} = 5V$	16 26 5		30 40 30	
$t_s$ $t_f$	RESISTIVE LOAD Storage Time Fall Time	$I_C = 2A \quad V_{CC} = 300V$ $I_{B1} = 0.4A \quad I_{B2} = -0.4A$ $t_p = 30\mu s$	3		4.5 350	$\mu s$ ns
$t_s$ $t_f$	INDUCTIVE LOAD Storage Time Fall Time	$I_C = 5A \quad V_{CL} = 250V$ $I_{B1} = 1A \quad I_{B2} = -2A$ $L = 200\mu H$		1.6 60	2.5 110	$\mu s$ ns
$t_s$ $t_f$	INDUCTIVE LOAD Storage Time Fall Time	$I_C = 5A \quad V_{CL} = 250V$ $I_{B1} = 1A \quad I_{B2} = -2A$ $L = 200\mu H \quad T_c = 125^{\circ}C$		2.3 110		$\mu s$ ns

\* Pulsed: Pulse duration = 300  $\mu s$ , duty cycle 2 %

Note : DC current gain pre-selected product (Group A and Group B). STMicroelectronics reserves the right to ship either groups according to production availability. Please contact your nearest STMicroelectronics sales office for delivery details.

Safe Operating Areas

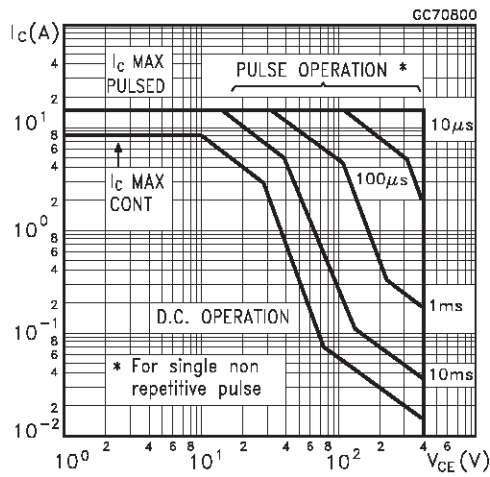

Derating Curve

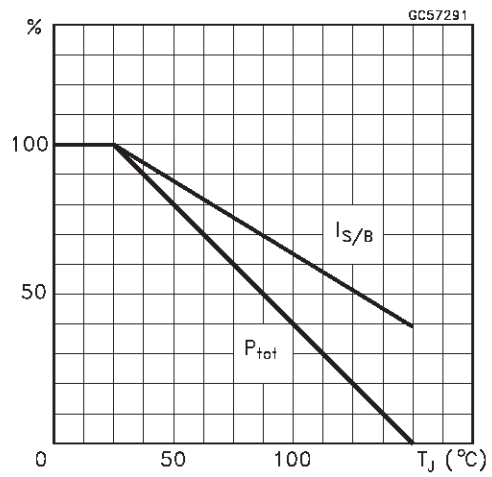

DC Current Gain

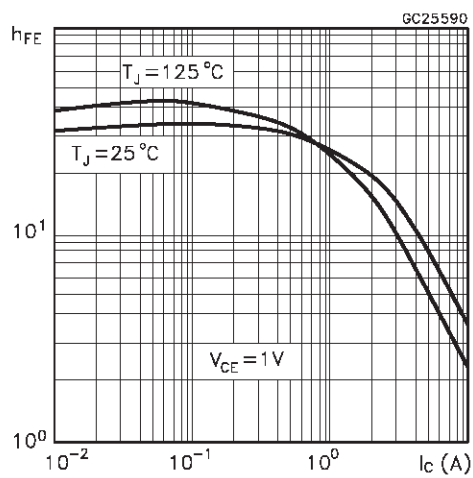

DC Current Gain

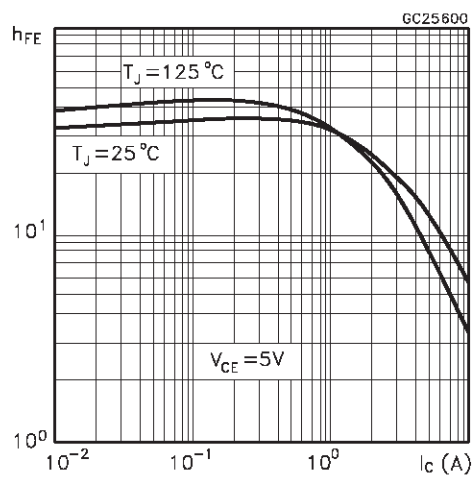

Collector Emitter Saturation Voltage

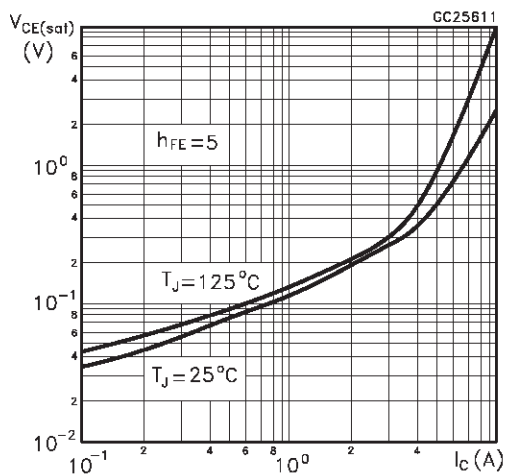

Base Emitter Saturation Voltage

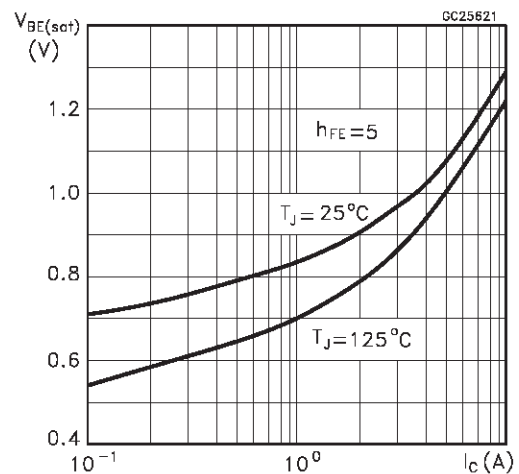

Inductive Fall Time

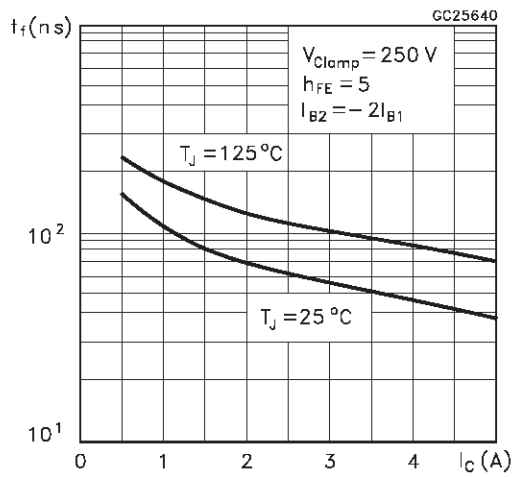

Inductive Storage Time

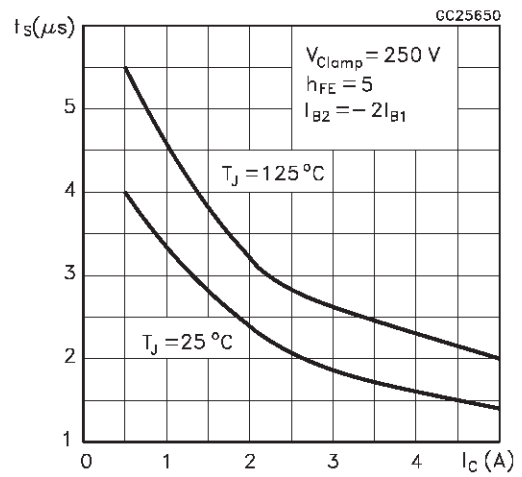

Reverse Biased SOA

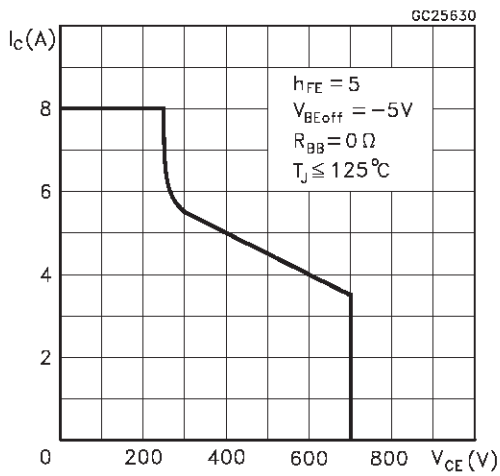

## TO-220 MECHANICAL DATA

DIM.	mm			inch		
	MIN.	TYP.	MAX.	MIN.	TYP.	MAX.
A	4.40		4.60	0.173		0.181
C	1.23		1.32	0.048		0.051
D	2.40		2.72	0.094		0.107
D1		1.27			0.050	
E	0.49		0.70	0.019		0.027
F	0.61		0.88	0.024		0.034
F1	1.14		1.70	0.044		0.067
F2	1.14		1.70	0.044		0.067
G	4.95		5.15	0.194		0.203
G1	2.4		2.7	0.094		0.106
H2	10.0		10.40	0.393		0.409
L2		16.4			0.645	
L4	13.0		14.0	0.511		0.551
L5	2.65		2.95	0.104		0.116
L6	15.25		15.75	0.600		0.620
L7	6.2		6.6	0.244		0.260
L9	3.5		3.93	0.137		0.154
DIA.	3.75		3.85	0.147		0.151

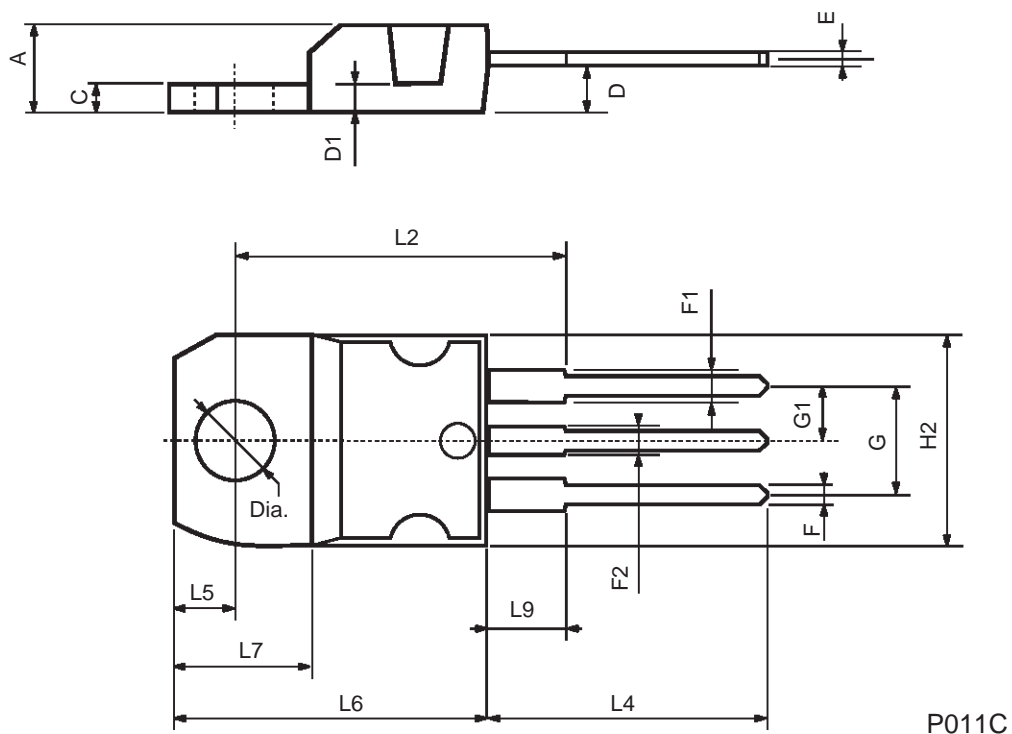

Information furnished is believed to be accurate and reliable. However, STMicroelectronics assumes no responsibility for the consequences of use of such information nor for any infringement of patents or other rights of third parties which may result from its use. No license is granted by implication or otherwise under any patent or patent rights of STMicroelectronics. Specification mentioned in this publication are subject to change without notice. This publication supersedes and replaces all information previously supplied. STMicroelectronics products are not authorized for use as critical components in life support devices or systems without express written approval of STMicroelectronics.

The ST logo is a trademark of STMicroelectronics

© 1998 STMicroelectronics – Printed in Italy – All Rights Reserved

STMicroelectronics GROUP OF COMPANIES

Australia - Brazil - Canada - China - France - Germany - Italy - Japan - Korea - Malaysia - Malta - Mexico - Morocco - The Netherlands - Singapore - Spain - Sweden - Switzerland - Taiwan - Thailand - United Kingdom - U.S.A.