

International Rectifier

ST330S SERIES

PHASE CONTROL THYRISTORS

Stud Version

Features

- Center amplifying gate
- Hermetic metal case with ceramic insulator
- International standard case TO-209AE (TO-118)
- Threaded studs UNF 3/4 - 16UNF2A or ISO M24x1.5
- Compression Bonded Encapsulation for heavy duty operations such as severe thermal cycling

330A

Typical Applications

- DC motor controls
- Controlled DC power supplies
- AC controllers

Major Ratings and Characteristics

Parameters	ST330S	Units
$I_{T(AV)}$	330	A
@ T_C	75	°C
$I_{T(RMS)}$	520	A
I_{TSM} @ 50Hz	9000	A
@ 60Hz	9420	A
I^2t @ 50Hz	405	KA ² s
@ 60Hz	370	KA ² s
V_{DRM}/V_{RRM}	400 to 1600	V
t_q typical	100	µs
T_J	- 40 to 125	°C

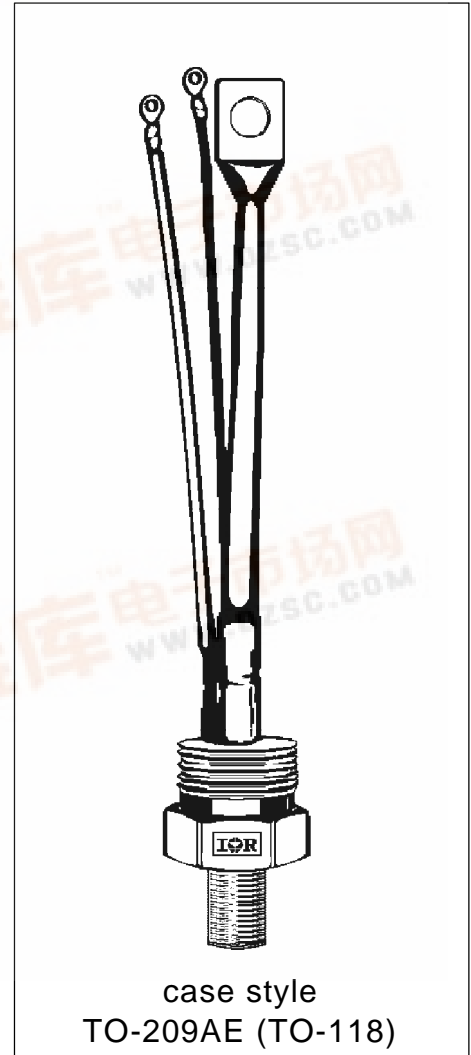

ST330S Series

ELECTRICAL SPECIFICATIONS

Voltage Ratings

Type number	Voltage Code	V_{DRM}/V_{RRM} , max. repetitive peak and off-state voltage V	V_{RSM} , maximum non-repetitive peak voltage V	I_{DRM}/I_{RRM} max. @ $T_J = T_J$ max mA
ST330S	04	400	500	50
	08	800	900	
	12	1200	1300	
	14	1400	1500	
	16	1600	1700	

On-state Conduction

Parameter	ST330S	Units	Conditions
$I_{T(AV)}$ Max. average on-state current @ Case temperature	330	A	180° conduction, half sine wave
	75	°C	
$I_{T(RMS)}$ Max. RMS on-state current	520	A	DC @ 62°C case temperature
I_{TSM} Max. peak, one-cycle non-repetitive surge current	9000	A	t = 10ms No voltage reappplied
	9420		t = 8.3ms
	7570		t = 10ms 100% V_{RRM} reappplied
	7920		t = 8.3ms
I^2t Maximum I^2t for fusing	405	KA ² s	t = 10ms No voltage reappplied
	370		t = 8.3ms
	287		t = 10ms 100% V_{RRM} reappplied
	262		t = 8.3ms
$I^2\sqrt{t}$ Maximum $I^2\sqrt{t}$ for fusing	4050	KA ² √s	t = 0.1 to 10ms, no voltage reappplied
$V_{T(TO)1}$ Low level value of threshold voltage	0.91	V	$(16.7\% \times \pi \times I_{T(AV)} < I < \pi \times I_{T(AV)})$, $T_J = T_J$ max.
$V_{T(TO)2}$ High level value of threshold voltage	0.92		$(I > \pi \times I_{T(AV)})$, $T_J = T_J$ max.
r_{t1} Low level value of on-state slope resistance	0.58	mΩ	$(16.7\% \times \pi \times I_{T(AV)} < I < \pi \times I_{T(AV)})$, $T_J = T_J$ max.
r_{t2} High level value of on-state slope resistance	0.57		$(I > \pi \times I_{T(AV)})$, $T_J = T_J$ max.
V_{TM} Max. on-state voltage	1.51	V	$I_{pk} = 1040A$, $T_J = T_J$ max, $t_p = 10ms$ sine pulse
I_H Maximum holding current	600	mA	$T_J = 25^\circ C$, anode supply 12V resistive load
I_L Typical latching current	1000		

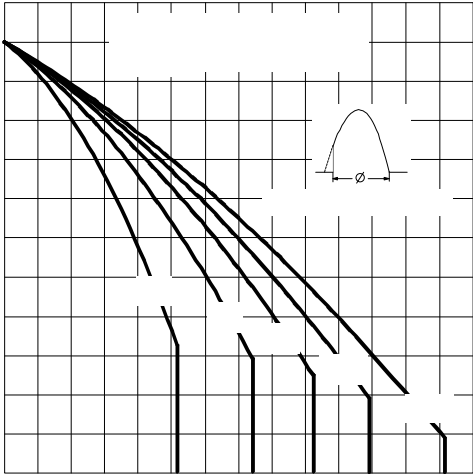

Fig. 1 - Current Ratings Characteristics

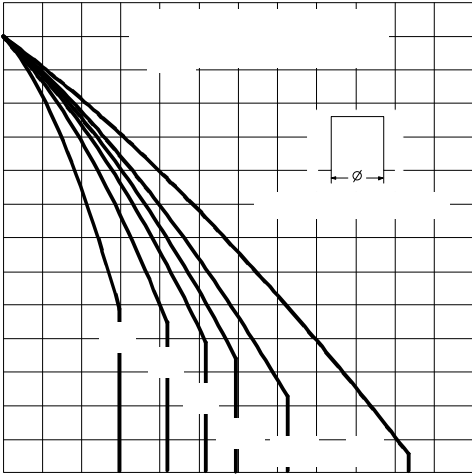

Fig. 2 - Current Ratings Characteristics

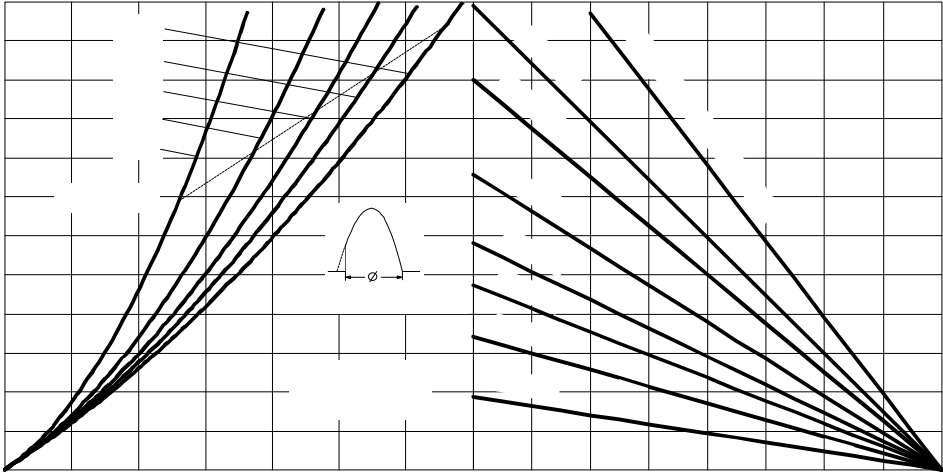
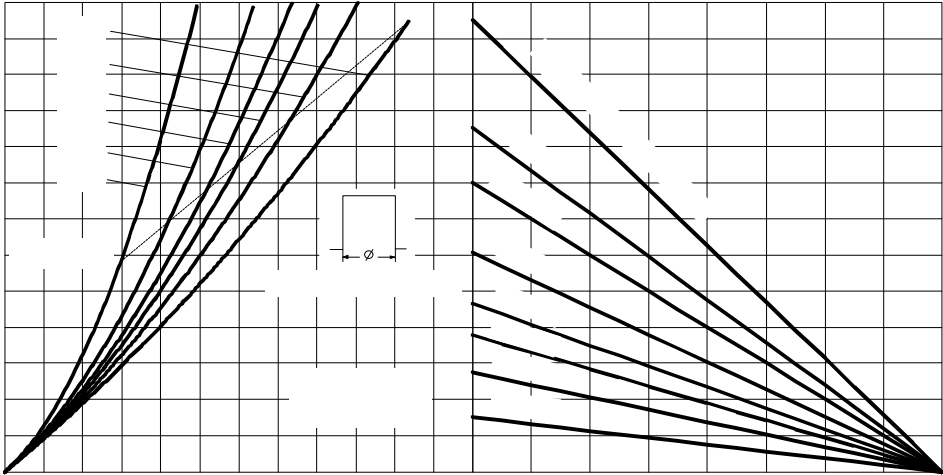

Fig. 3 - On-state Power Loss Characteristics



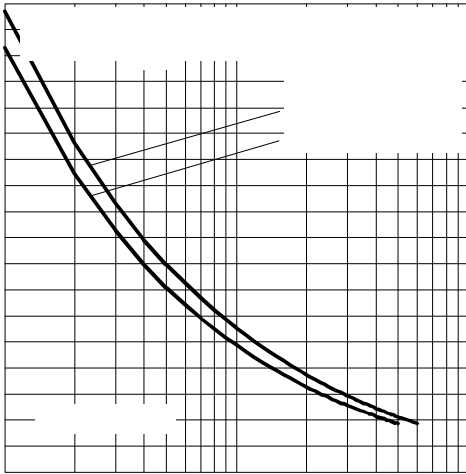

Fig. 5 - Maximum Non-Repetitive Surge Current

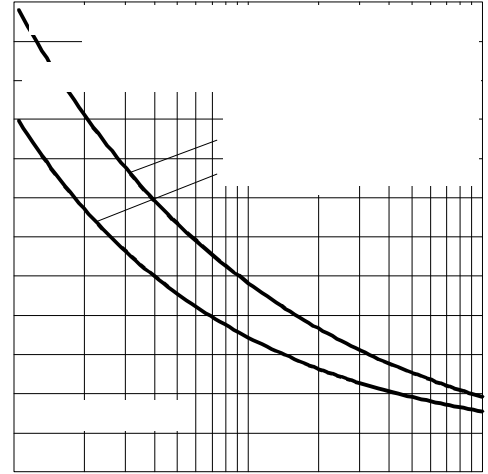

Fig. 6 - Maximum Non-Repetitive Surge Current

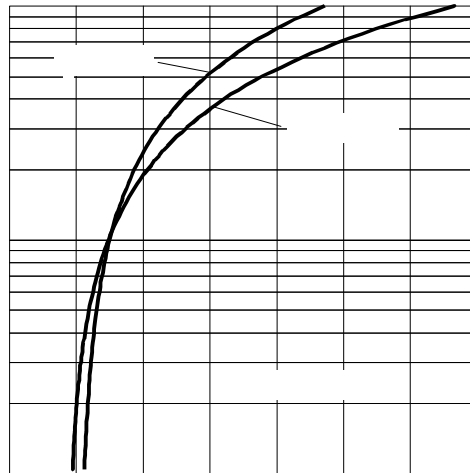
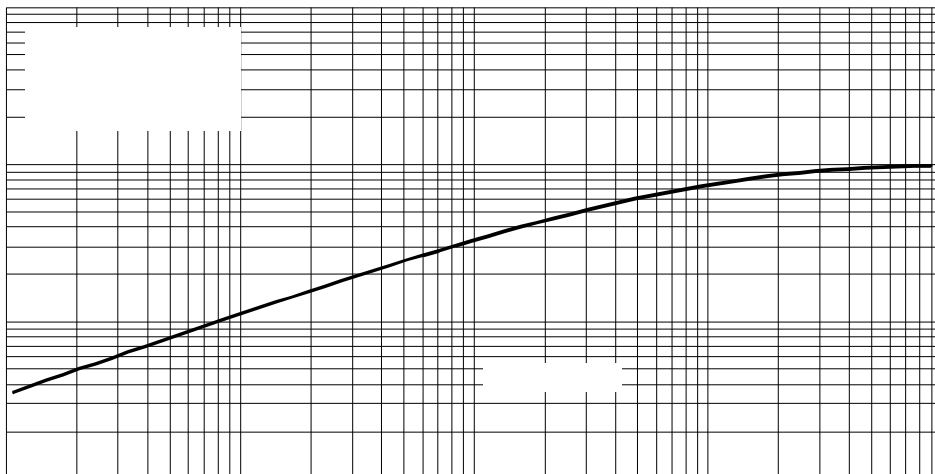

Fig. 7 - On-state Voltage Drop Characteristics



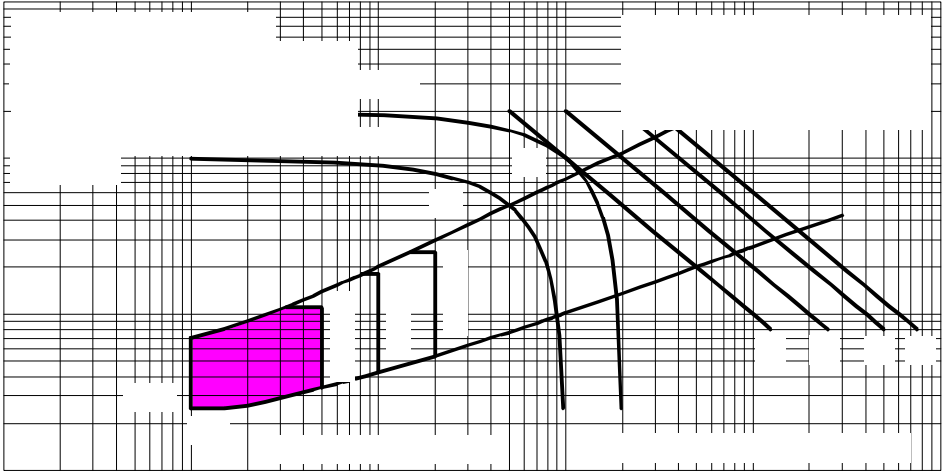

Fig. 9 - Gate Characteristics

Switching

Parameter	ST330S	Units	Conditions
di/dt Max. non-repetitive rate of rise of turned-on current	1000	A/ μ s	Gate drive 20V, 20 Ω , $t_r \leq 1\mu$ s $T_J = T_J$ max, anode voltage $\leq 80\% V_{DRM}$
t_d Typical delay time	1.0	μ s	Gate current A, $di_g/dt = 1A/\mu$ s $V_d = 0.67\% V_{DRM}$, $T_J = 25^\circ$ C
t_q Typical turn-off time	100		$I_{TM} = 550A$, $T_J = T_J$ max, $di/dt = 40A/\mu$ s, $V_R = 50V$ $dv/dt = 20V/\mu$ s, Gate 0V 100 Ω , $t_p = 500\mu$ s

Blocking

Parameter	ST330S	Units	Conditions
dv/dt Maximum critical rate of rise of off-state voltage	500	V/ μ s	$T_J = T_J$ max. linear to 80% rated V_{DRM}
I_{RRM} I_{DRM} Max. peak reverse and off-state leakage current	50	mA	$T_J = T_J$ max, rated V_{DRM}/V_{RRM} applied

Triggering

Parameter	ST330S		Units	Conditions
P_{GM} Maximum peak gate power	10.0		W	$T_J = T_J$ max, $t_p \leq 5ms$
$P_{G(AV)}$ Maximum average gate power	2.0			$T_J = T_J$ max, $f = 50Hz$, $d\% = 50$
I_{GM} Max. peak positive gate current	3.0		A	$T_J = T_J$ max, $t_p \leq 5ms$
$+V_{GM}$ Maximum peak positive gate voltage	20		V	$T_J = T_J$ max, $t_p \leq 5ms$
$-V_{GM}$ Maximum peak negative gate voltage	5.0			
I_{GT} DC gate current required to trigger	TYP.	MAX.	mA	$T_J = -40^\circ$ C $T_J = 25^\circ$ C $T_J = 125^\circ$ C Max. required gate trigger/ current/ voltage are the lowest value which will trigger all units 12V anode-to-cathode applied
	200	-		
	100	200		
V_{GT} DC gate voltage required to trigger	2.5	-	V	$T_J = -40^\circ$ C $T_J = 25^\circ$ C $T_J = 125^\circ$ C
	1.8	3.0		
	1.1	-		
I_{GD} DC gate current not to trigger	10		mA	$T_J = T_J$ max Max. gate current/ voltage not to trigger is the max. value which will not trigger any unit with rated V_{DRM} anode-to-cathode applied
V_{GD} DC gate voltage not to trigger	0.25		V	

ST330S Series

Thermal and Mechanical Specification

Parameter	ST330S	Units	Conditions
T_J Max. operating temperature range	-40 to 125	°C	
T_{stg} Max. storage temperature range	-40 to 150		
R_{thJC} Max. thermal resistance, junction to case	0.10	K/W	DC operation
R_{thCS} Max. thermal resistance, case to heatsink	0.03		Mounting surface, smooth, flat and greased
T Mounting torque, $\pm 10\%$	48.5 (425)	Nm (lbf-in)	Non lubricated threads
wt Approximate weight	535	g	
Case style	TO - 209AE (TO-118)		See Outline Table

ΔR_{thJC} Conduction

(The following table shows the increment of thermal resistance R_{thJC} when devices operate at different conduction angles than DC)

Conduction angle	Sinusoidal conduction	Rectangular conduction	Units	Conditions
180°	0.011	0.008	K/W	$T_J = T_J \text{ max.}$
120°	0.013	0.014		
90°	0.017	0.018		
60°	0.025	0.026		
30°	0.041	0.041		

Ordering Information Table

Device Code

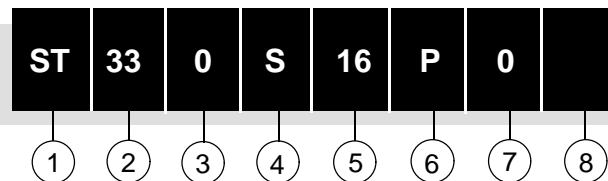

- 1** - Thyristor
- 2** - Essential part number
- 3** - 0 = Converter grade
- 4** - S = Compression bonding Stud
- 5** - Voltage code: Code x 100 = V_{RRM} (See Voltage Rating Table)
- 6** - P = Stud base 16UNF threads
M = Stud base metric threads (M24 x 1.5)
- 7** - 0 = Eyelet terminals (Gate and Auxiliary Cathode Leads)
1 = Fast - on terminals (Gate and Auxiliary Cathode Leads)
3 = Threaded top terminal 3/8" 24UNF-2A
- 8** - Critical dv/dt: None = 500V/ μ sec (Standard selection)
L = 1000V/ μ sec (Special selection)

Outline Table

CERAMIC HOUSING

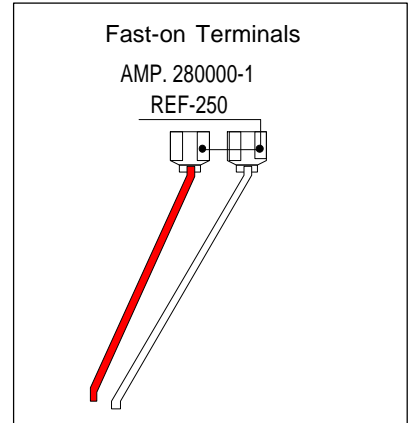
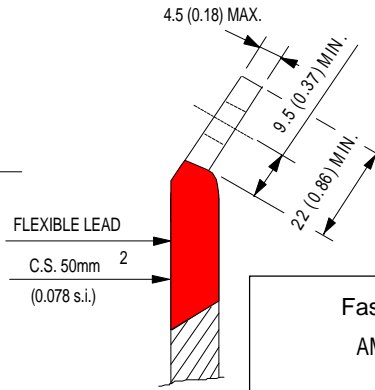
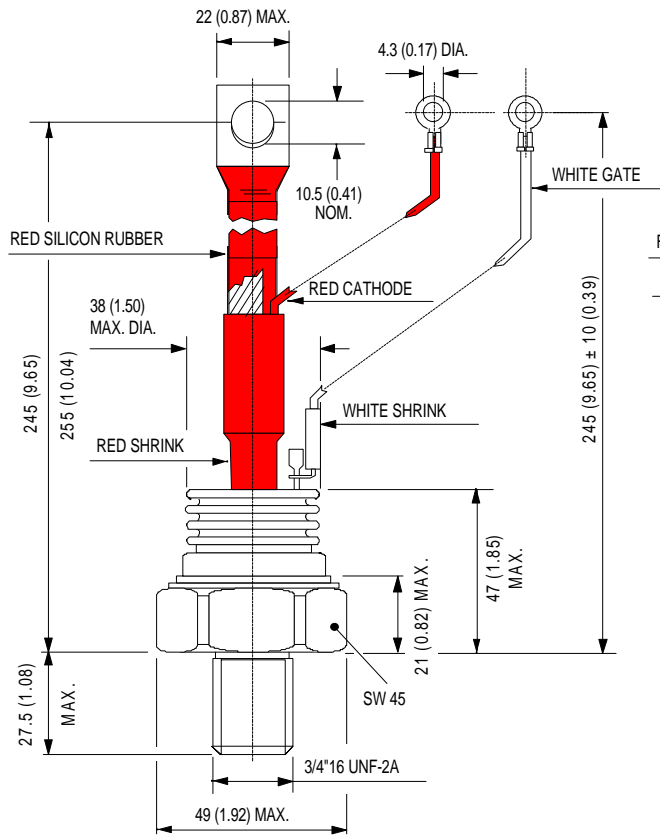

Case Style TO-209AE (TO-118)
All dimensions in millimeters (inches)

* FOR METRIC DEVICE: M24 X 1.5 - LENGHT SCREW 21 (0.83) MAX.

CERAMIC HOUSING

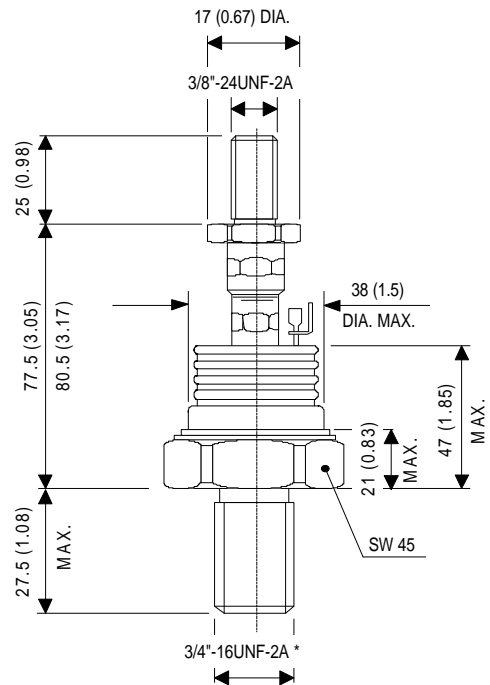

Case Style TO-209AE (TO-118)
with top thread terminal 3/8"
All dimensions in millimeters (inches)

* FOR METRIC DEVICE: M24 x 1.5 - LENGHT SCREW 21 (0.83) MAX.