

Bulletin I25169 rev.C 04/00

International IOR Rectifier

ST380CH..C SERIES

PHASE CONTROL THYRISTORS

Hockey Puk Version

Features

- Center amplifying gate
- Metal case with ceramic insulator
- International standard case TO-200AB (E-PUK)
- Low profile hockey-puk to increase current-carrying capability
- Extended temperature range

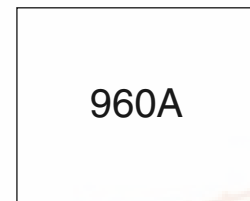

Typical Applications

- DC motor controls
- Controlled DC power supplies
- AC controllers

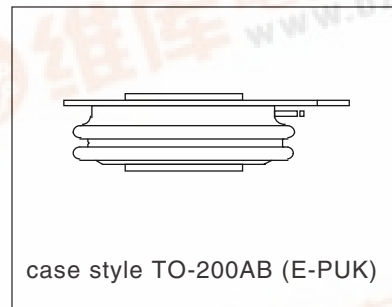

Major Ratings and Characteristics

Parameters	ST380CH..C	Units
$I_{T(AV)}$	960	A
@ T_{hs}	80	°C
$I_{T(RMS)}$	2220	A
@ T_{hs}	25	°C
I_{TSM}	@ 50Hz 12500	A
	@ 60Hz 13000	A
I^2t	@ 50Hz 782	KA ² s
	@ 60Hz 713	KA ² s
V_{DRM}/V_{RRM}	400 to 600	V
t_q typical	100	μs
T_J	- 40 to 150	°C

ST380CH..C Series

Bulletin I25169 rev.C 04/00

International
IOR Rectifier

ELECTRICAL SPECIFICATIONS

Voltage Ratings

Type number	Voltage Code	V_{DRM}/V_{RRM} , max. repetitive peak and off-state voltage V	V_{RSM} , maximum non-repetitive peak voltage V	I_{DRM}/I_{RRM} max. @ $T_J = T_J$ max mA
ST380CH..C	04	400	500	100
	06	600	700	

On-state Conduction

Parameter	ST380CH..C	Units	Conditions	
$I_{T(AV)}$ Max. average on-state current @ Heatsink temperature	960 (440)	A	180° conduction, half sine wave double side (single side) cooled	
	80 (110)	°C		
$I_{T(RMS)}$ Max. RMS on-state current	2220	A	DC @ 25°C heatsink temperature double side cooled	
I_{TSM} Max. peak, one-cycle non-repetitive surge current	12500		t = 10ms	No voltage
	13000		t = 8.3ms	reapplied
	10500		t = 10ms	100% V_{RRM}
	11000	t = 8.3ms	reapplied	
I^2t Maximum I^2t for fusing	782	KA ² s	t = 10ms	No voltage
	713		t = 8.3ms	reapplied
	553		t = 10ms	100% V_{RRM}
	505		t = 8.3ms	reapplied
$I^2\sqrt{t}$ Maximum $I^2\sqrt{t}$ for fusing	7820	KA ² √s	t = 0.1 to 10ms, no voltage reapplied	
$V_{T(TO)1}$ Low level value of threshold voltage	0.85	V	$(16.7\% \times \pi \times I_{T(AV)} < I < \pi \times I_{T(AV)})$, $T_J = T_J$ max.	
$V_{T(TO)2}$ High level value of threshold voltage	0.88		$(I > \pi \times I_{T(AV)})$, $T_J = T_J$ max.	
r_{t1} Low level value of on-state slope resistance	0.25	mΩ	$(16.7\% \times \pi \times I_{T(AV)} < I < \pi \times I_{T(AV)})$, $T_J = T_J$ max.	
r_{t2} High level value of on-state slope resistance	0.24		$(I > \pi \times I_{T(AV)})$, $T_J = T_J$ max.	
V_{TM} Max. on-state voltage	1.58	V	$I_{pk} = 2900A$, $T_J = T_J$ max, $t_p = 10ms$ sine pulse	
I_H Maximum holding current	600	mA	$T_J = 25^\circ C$, anode supply 12V resistive load	
I_L Typical latching current	1000			

Switching

Parameter	ST380CH..C	Units	Conditions
di/dt Max. non-repetitive rate of rise of turned-on current	1000	A/μs	Gate drive 20V, 20Ω, $t_r \leq 1\mu s$ $T_J = T_J$ max, anode voltage $\leq 80\% V_{DRM}$
t_d Typical delay time	1.0	μs	Gate current 1A, $di_g/dt = 1A/\mu s$ $V_d = 0.67\% V_{DRM}$, $T_J = 25^\circ C$
t_q Typical turn-off time	100		$I_{TM} = 550A$, $T_J = T_J$ max, $di/dt = 40A/\mu s$, $V_R = 50V$ $dv/dt = 20V/\mu s$, Gate 0V 100Ω, $t_p = 500\mu s$

Blocking

Parameter	ST380CH..C	Units	Conditions
dv/dt Maximum critical rate of rise of off-state voltage	500	V/ μ s	$T_J = T_J$ max. linear to 80% rated V_{DRM}
I_{RRM} I_{DRM} Max. peak reverse and off-state leakage current	100	mA	$T_J = T_J$ max, rated V_{DRM}/V_{RRM} applied

Triggering

Parameter	ST380CH..C	Units	Conditions
P_{GM} Maximum peak gate power	10.0	W	$T_J = T_J$ max, $t_p \leq 5$ ms
$P_{G(AV)}$ Maximum average gate power	2.0		$T_J = T_J$ max, $f = 50$ Hz, $d\% = 50$
I_{GM} Max. peak positive gate current	3.0	A	$T_J = T_J$ max, $t_p \leq 5$ ms
$+V_{GM}$ Maximum peak positive gate voltage	20	V	$T_J = T_J$ max, $t_p \leq 5$ ms
$-V_{GM}$ Maximum peak negative gate voltage	5.0		
I_{GT} DC gate current required to trigger	TYP.	MAX.	$T_J = -40^\circ\text{C}$ $T_J = 25^\circ\text{C}$ $T_J = 150^\circ\text{C}$ Max. required gate trigger/ current/ voltage are the lowest value which will trigger all units 12V anode-to-cathode applied
	200	-	
	100	200	
V_{GT} DC gate voltage required to trigger	2.5	-	$T_J = -40^\circ\text{C}$ $T_J = 25^\circ\text{C}$ $T_J = 150^\circ\text{C}$
	1.8	3.0	
	1.0	-	
I_{GD} DC gate current not to trigger	10	mA	$T_J = T_J$ max Max. gate current/voltage not to trigger is the max. value which will not trigger any unit with rated V_{DRM} anode-to-cathode applied
V_{GD} DC gate voltage not to trigger	0.25	V	

Thermal and Mechanical Specification

Parameter	ST380CH..C	Units	Conditions
T_J Max. operating temperature range	-40 to 150	$^\circ\text{C}$	
T_{stg} Max. storage temperature range	-40 to 150		
R_{thJ-hs} Max. thermal resistance, junction to heatsink	0.09	K/W	DC operation single side cooled
	0.04		DC operation double side cooled
R_{thC-hs} Max. thermal resistance, case to heatsink	0.02	K/W	DC operation single side cooled
	0.01		DC operation double side cooled
F Mounting force, $\pm 10\%$	9800	N	
	(1000)	(Kg)	
wt Approximate weight	83	g	
Case style	TO - 200AB (E-PUK)		See Outline Table

ST380CH..C Series

Bulletin I25169 rev.C 04/00

International
IRF Rectifier

ΔR_{thJ-hs} Conduction

(The following table shows the increment of thermal resistance R_{thJ-hs} when devices operate at different conduction angles than DC)

Conduction angle	Sinusoidal conduction		Rectangular conduction		Units	Conditions
	Single Side	Double Side	Single Side	Double Side		
180°	0.010	0.011	0.007	0.007	K/W	$T_J = T_{J \text{ max.}}$
120°	0.012	0.012	0.012	0.013		
90°	0.015	0.015	0.016	0.017		
60°	0.022	0.022	0.023	0.023		
30°	0.036	0.036	0.036	0.037		

Ordering Information Table

Device Code							
ST	38	0	CH	06	C	1	
①	②	③	④	⑤	⑥	⑦	⑧
1	- Thyristor						
2	- Essential part number						
3	- 0 = Converter grade						
4	- CH = Ceramic Puk, High temperature						
5	- Voltage code: Code x 100 = V_{RRM} (See Voltage Rating Table)						
6	- C = Puk Case TO-200AB (E-PUK)						
7	- 0 = Eyelet terminals (Gate and Auxiliary Cathode Unsoldered Leads)						
	1 = Fast-on terminals (Gate and Auxiliary Cathode Unsoldered Leads)						
	2 = Eyelet terminals (Gate and Auxiliary Cathode Soldered Leads)						
	3 = Fast-on terminals (Gate and Auxiliary Cathode Soldered Leads)						
8	- Critical dv/dt: None = 500V/ μ sec (Standard selection)						
	L = 1000V/ μ sec (Special selection)						

Outline Table

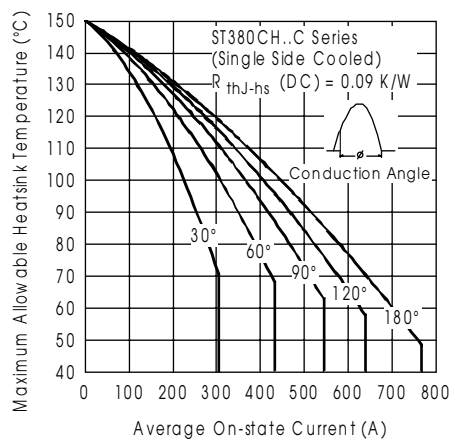
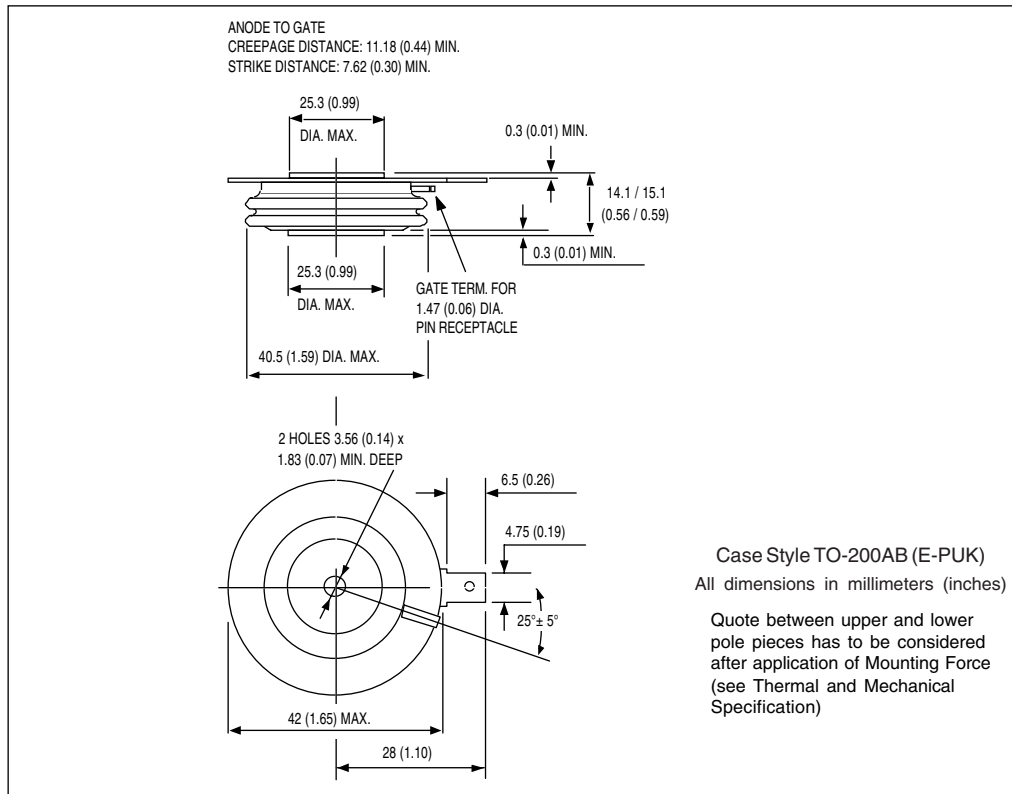

Fig. 1 - Current Ratings Characteristics

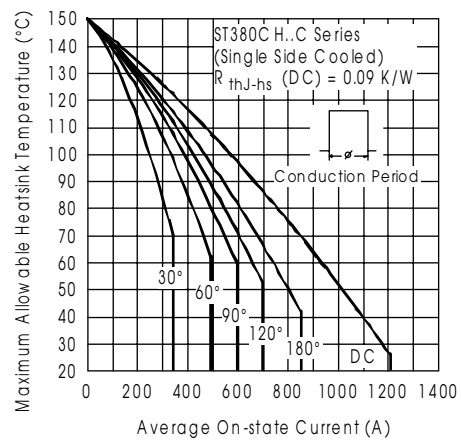

Fig. 2 - Current Ratings Characteristics

ST380CH..C Series

Bulletin I25169 rev. C 04/00

International
IRF Rectifier

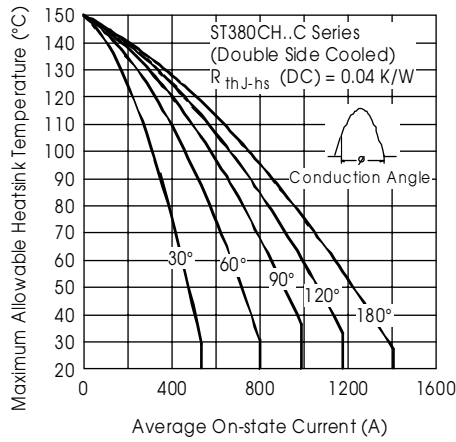

Fig. 3 - Current Ratings Characteristics

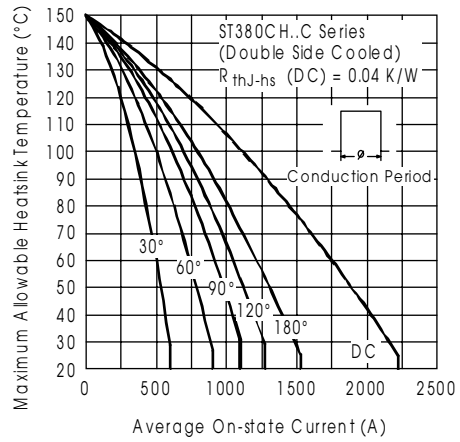

Fig. 4 - Current Ratings Characteristics

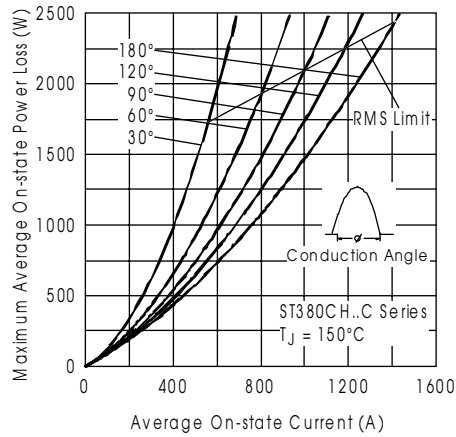

Fig. 5 - On-state Power Loss Characteristics

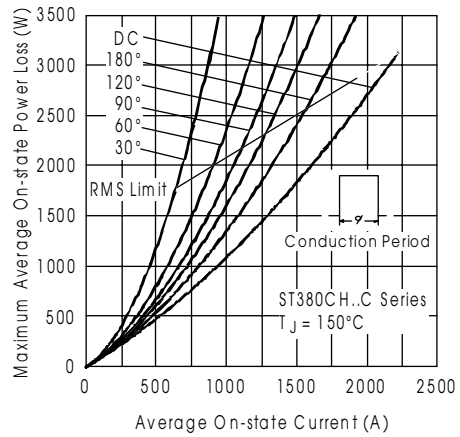

Fig. 6 - On-state Power Loss Characteristics

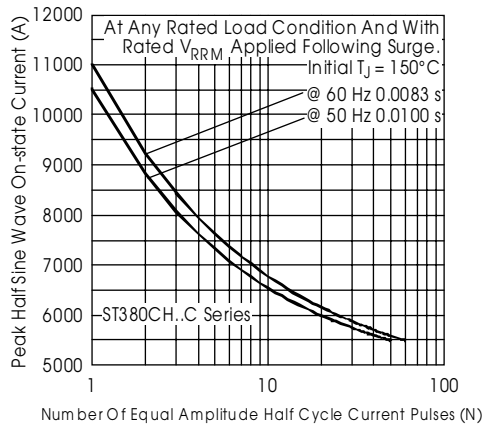

Fig. 7 - Maximum Non-Repetitive Surge Current Single and Double Side Cooled

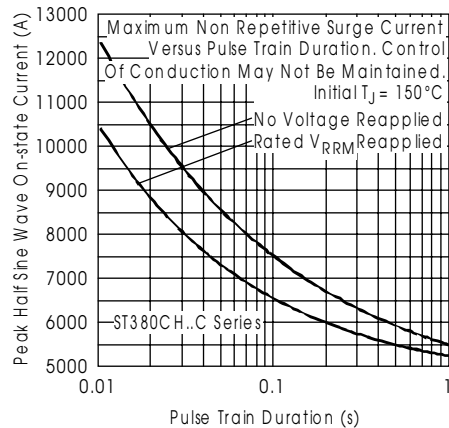

Fig. 8 - Maximum Non-Repetitive Surge Current Single and Double Side Cooled

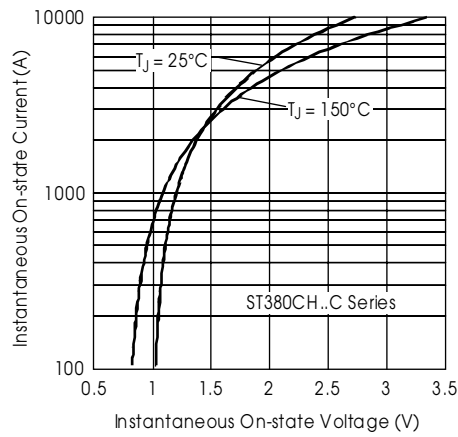

Fig. 9 - On-state Voltage Drop Characteristics

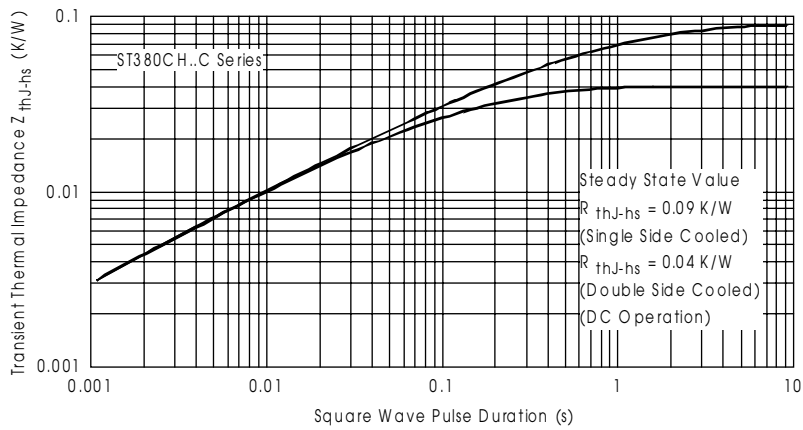

Fig. 10 - Thermal Impedance Z_{thJ-hs} Characteristics

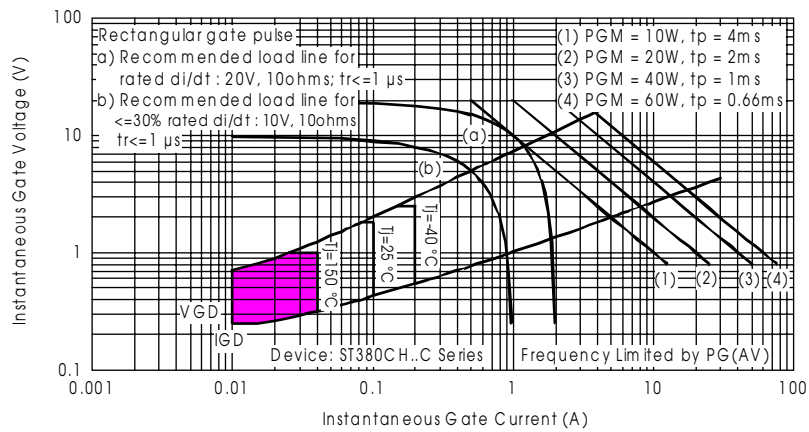

Fig. 11 - Gate Characteristics