

INVERTER GRADE THYRISTORS

Hockey Puk Version

Features

- Metal case with ceramic insulator
- International standard case TO-200AC (B-PUK)
- All diffused design
- Center amplifying gate
- Guaranteed high dV/dt
- Guaranteed high dI/dt
- High surge current capability
- Low thermal impedance
- High speed performance

Typical Applications

- Inverters
- Choppers
- Induction heating
- All types of force-commutated converters

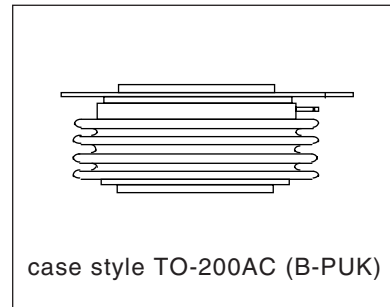
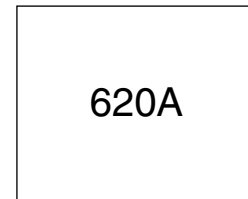

Major Ratings and Characteristics

Parameters	ST333C..L	Units
$I_{T(AV)}$	620	A
	@ T_{hs}	55 °C
$I_{T(RMS)}$	1230	A
	@ T_{hs}	25 °C
I_{TSM}	@ 50Hz	11000 A
	@ 60Hz	11500 A
I^2t	@ 50Hz	605 KA ² s
	@ 60Hz	553 KA ² s
V_{DRM}/V_{RRM}	400 to 800	V
t_q range	10 to 30	μs
T_J	- 40 to 125	°C

ST333C..L Series

Bulletin I25187 rev. B 04/00

International
IRF Rectifier

ELECTRICAL SPECIFICATIONS

Voltage Ratings

Type number	Voltage Code	V_{DRM}/V_{RRM} , maximum repetitive peak voltage V	V_{RSM} , maximum non-repetitive peak voltage V	I_{DRM}/I_{RRM} max. @ $T_J = T_J$ max. mA
ST333C..L	04	400	500	50
	08	800	900	

Current Carrying Capability

Frequency							Units
50Hz	1430	1250	2340	1940	6310	5620	A
400Hz	1670	1170	2310	2010	3440	5030	
1000Hz	1080	880	2090	1800	2040	1750	
2500Hz	530	400	1190	990	990	800	
Recovery voltage Vr	50	50	50	50	50	50	V
Voltage before turn-on Vd	V_{DRM}		V_{DRM}		V_{DRM}		
Rise of on-state current di/dt	50	50	-	-	-	-	A/µs
Heatsink temperature	40	55	40	55	40	55	°C
Equivalent values for RC circuit	10Ω / 0.47µF		10Ω / 0.47µF		10Ω / 0.47µF		

On-state Conduction

Parameter	ST333C..L	Units	Conditions	
$I_{T(AV)}$ Max. average on-state current @ Heatsink temperature	620 (305)	A	180° conduction, half sine wave double side (single side) cooled	
	55 (75)	°C		
$I_{T(RMS)}$ Max. RMS on-state current	1230	A	DC @ 25°C heatsink temperature double side cooled	
I_{TSM} Max. peak, one half cycle, non-repetitive surge current	11000		t = 10ms	No voltage reappplied
	11500		t = 8.3ms	reappplied
	9250		t = 10ms	100% V_{RRM}
	9700		t = 8.3ms	reappplied
I^2t Maximum I^2t for fusing	605		KA ² s	t = 10ms
	553			t = 8.3ms
	428			t = 10ms
	391	t = 8.3ms		
$I^2\sqrt{t}$ Maximum $I^2\sqrt{t}$ for fusing	6050	KA ² √s	t = 0.1 to 10ms, no voltage reappplied	

On-state Conduction

Parameter	ST333C..L	Units	Conditions
V_{TM} Max. peak on-state voltage	1.96	V	$I_{TM} = 1810A, T_J = T_J \text{ max}, t_p = 10\text{ms sine wave pulse}$
$V_{T(TO)1}$ Low level value of threshold voltage	0.91		$(16.7\% \times \pi \times I_{T(AV)} < I < \pi \times I_{T(AV)}, T_J = T_J \text{ max.}$
$V_{T(TO)2}$ High level value of threshold voltage	0.93		$(I > \pi \times I_{T(AV)}, T_J = T_J \text{ max.}$
r_{t1} Low level value of forward slope resistance	0.58	m Ω	$(16.7\% \times \pi \times I_{T(AV)} < I < \pi \times I_{T(AV)}, T_J = T_J \text{ max.}$
r_{t2} High level value of forward slope resistance	0.58		$(I > \pi \times I_{T(AV)}, T_J = T_J \text{ max.}$
I_H Maximum holding current	600	mA	$T_J = 25^\circ\text{C}, I_T > 30A$
I_L Typical latching current	1000		$T_J = 25^\circ\text{C}, V_A = 12V, R_a = 6\Omega, I_G = 1A$

Switching

Parameter	ST333C..L	Units	Conditions
di/dt Max. non-repetitive rate of rise of turned-on current	1000	A/ μs	$T_J = T_J \text{ max}, V_{DRM} = \text{rated } V_{DRM}$ $I_{TM} = 2 \times \text{di/dt}$
t_d Typical delay time	1.1	μs	$T_J = 25^\circ\text{C}, V_{DM} = \text{rated } V_{DRM}, I_{TM} = 50A \text{ DC}, t_p = 1\mu\text{s}$ Resistive load, Gate pulse: 10V, 5 Ω source
t_q Max. turn-off time	Min 10 Max 30		$T_J = T_J \text{ max}, I_{TM} = 550A, \text{commutating di/dt} = 40A/\mu\text{s}$ $V_R = 50V, t_p = 500\mu\text{s}, \text{dv/dt: see table in device code}$

Blocking

Parameter	ST333C..L	Units	Conditions
dv/dt Maximum critical rate of rise of off-state voltage	500	V/ μs	$T_J = T_J \text{ max. linear to } 80\% V_{DRM}, \text{higher value available on request}$
I_{RRM} I_{DRM} Max. peak reverse and off-state leakage current	50	mA	$T_J = T_J \text{ max, rated } V_{DRM}/V_{RRM} \text{ applied}$

Triggering

Parameter	ST333C..L	Units	Conditions
P_{GM} Maximum peak gate power	60	W	$T_J = T_J \text{ max.}, f = 50\text{Hz}, d\% = 50$
$P_{G(AV)}$ Maximum average gate power	10		
I_{GM} Max. peak positive gate current	10	A	$T_J = T_J \text{ max}, t_p \leq 5\text{ms}$
$+V_{GM}$ Maximum peak positive gate voltage	20	V	$T_J = T_J \text{ max}, t_p \leq 5\text{ms}$
$-V_{GM}$ Maximum peak negative gate voltage	5		
I_{GT} Max. DC gate current required to trigger	200	mA	$T_J = 25^\circ\text{C}, V_A = 12V, R_a = 6\Omega$
V_{GT} Max. DC gate voltage required to trigger	3	V	
I_{GD} Max. DC gate current not to trigger	20	mA	$T_J = T_J \text{ max, rated } V_{DRM} \text{ applied}$
V_{GD} Max. DC gate voltage not to trigger	0.25		

ST333C..L Series

Bulletin I25187 rev. B 04/00

International
IRF Rectifier

Thermal and Mechanical Specification

Parameter	ST333C..L	Units	Conditions
T_J Max. operating temperature range	-40 to 125	°C	
T_{stg} Max. storage temperature range	-40 to 150		
R_{thJ-hs} Max. thermal resistance, junction to heatsink	0.11	K/W	DC operation single side cooled
	0.05		DC operation double side cooled
R_{thC-hs} Max. thermal resistance, case to heatsink	0.011	K/W	DC operation single side cooled
	0.005		DC operation double side cooled
F Mounting force, $\pm 10\%$	9800 (1000)	N (Kg)	
wt Approximate weight	250	g	
Case style	TO - 200AC (B-PUK)		See Outline Table

ΔR_{thJ-hs} Conduction

(The following table shows the increment of thermal resistance R_{thJ-hs} when devices operate at different conduction angles than DC)

Conduction angle	Sinusoidal conduction		Rectangular conduction		Units	Conditions
	Single Side	Double Side	Single Side	Double Side		
180°	0.012	0.010	0.008	0.008	K/W	$T_J = T_J \text{ max.}$
120°	0.014	0.015	0.014	0.014		
90°	0.018	0.018	0.019	0.019		
60°	0.026	0.027	0.027	0.028		
30°	0.045	0.046	0.046	0.046		

Ordering Information Table

Device Code									
ST	33	3	C	08	L	H	K	1	
①	②	③	④	⑤	⑥	⑦	⑧	⑨	⑩
1	- Thyristor								
2	- Essential part number								
3	- 3 = Fast turn off								
4	- C = Ceramic Puk								
5	- Voltage code: Code x 100 = V_{RRM} (See Voltage Rating Table)								
6	- L = Puk Case TO-200AC (B-PUK)								
7	- Reapplied dv/dt code (for t_q test condition)								
8	- t_q code								
9	- 0 = Eyelet term. (Gate and Aux. Cathode Unsoldered Leads)								
	1 = Fast-on term. (Gate and Aux. Cathode Unsoldered Leads)								
	2 = Eyelet term. (Gate and Aux. Cathode Soldered Leads)								
	3 = Fast-on term. (Gate and Aux. Cathode Soldered Leads)								
10	- Critical dv/dt:								
	None = 500V/ μsec (Standard value)								
	L = 1000V/ μsec (Special selection)								

dv/dt - t_q combinations available					
dv/dt (V/ μs)	20	50	100	200	400
10	CN	DN	EN	--	--
12	CM	DM	EM	FM *	--
15	CL	DL	EL	FL *	HL
18	CP	DP	EP	FP	HP
20	CK	DK	EK	FK	HK
25	--	--	--	FJ	HJ
30	--	--	--	--	HH

*Standard part number.
All other types available only on request.

Outline Table

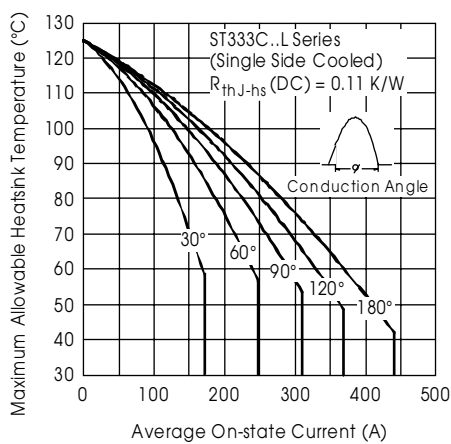
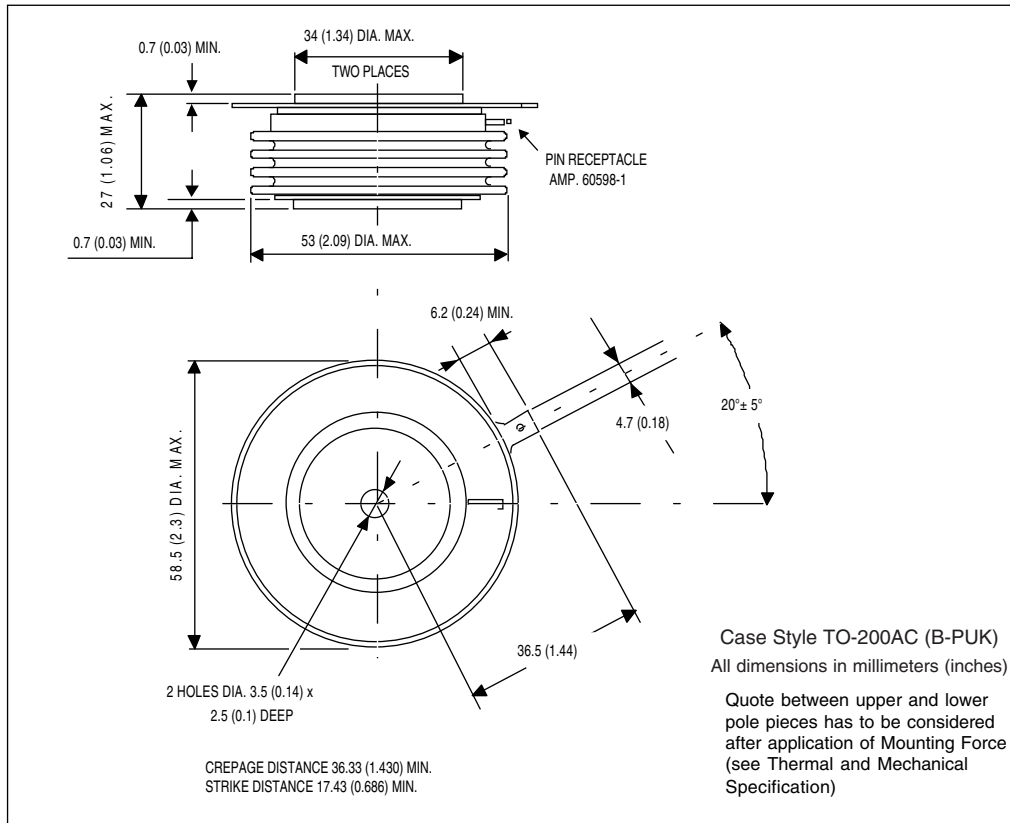

Fig. 1 - Current Ratings Characteristics

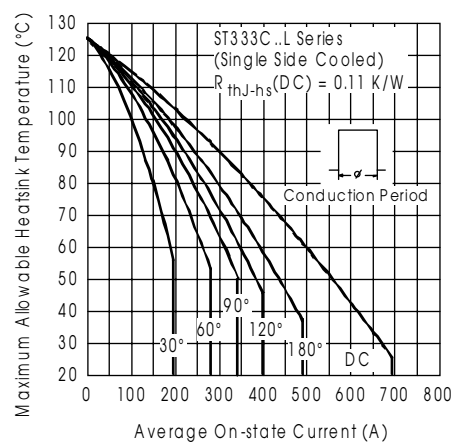

Fig. 2 - Current Ratings Characteristics

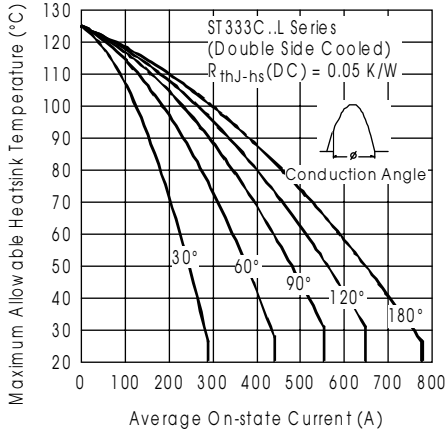

Fig. 3 - Current Ratings Characteristics

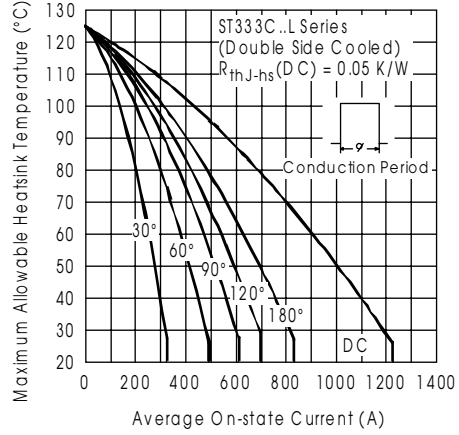

Fig. 4 - Current Ratings Characteristics

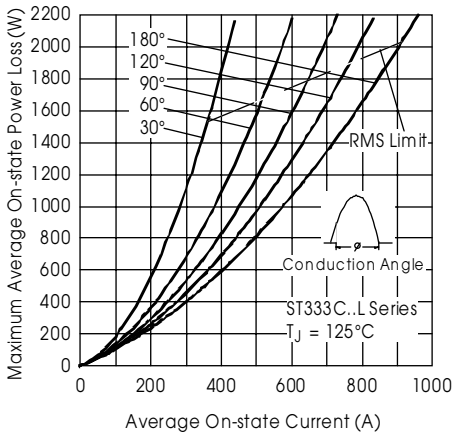

Fig. 5 - On-state Power Loss Characteristics

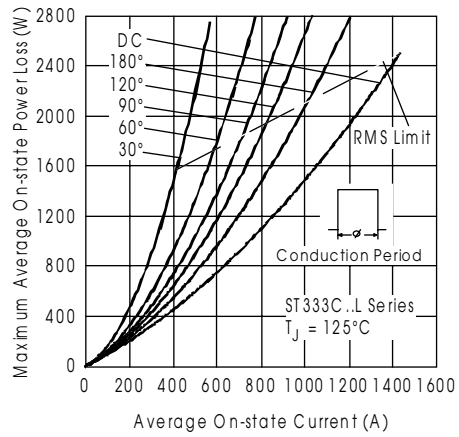

Fig. 6 - On-state Power Loss Characteristics

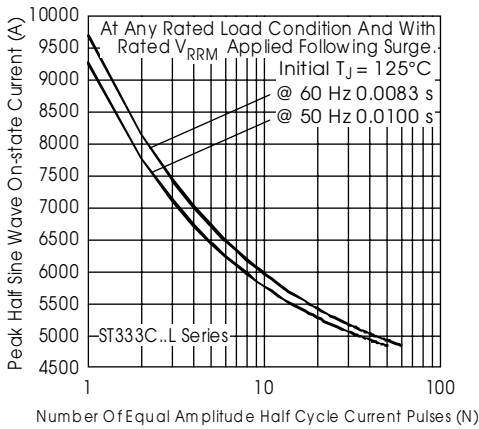

Fig. 7 - Maximum Non-repetitive Surge Current Single and Double Side Cooled

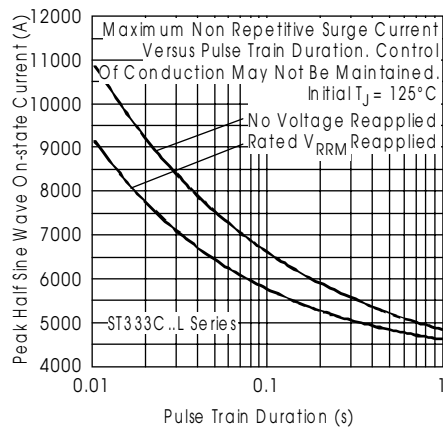

Fig. 8 - Maximum Non-repetitive Surge Current Single and Double Side Cooled

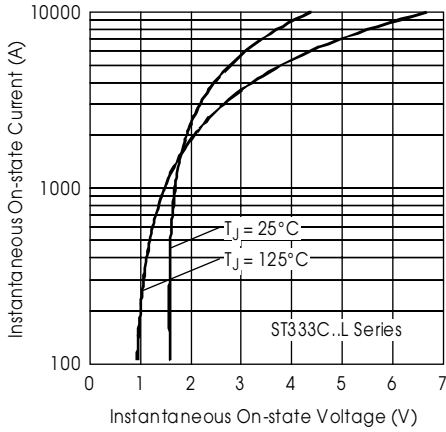

Fig. 9 - On-state Voltage Drop Characteristics

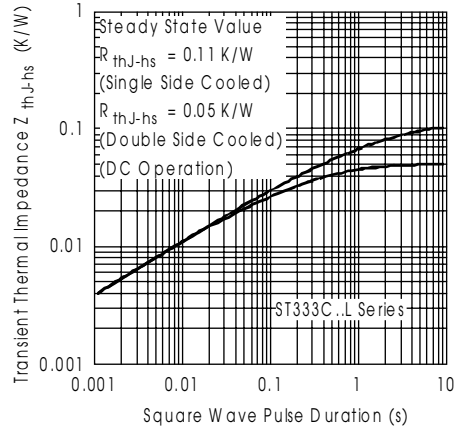

Fig. 10 - Thermal Impedance Z_{thJ-hs} Characteristics

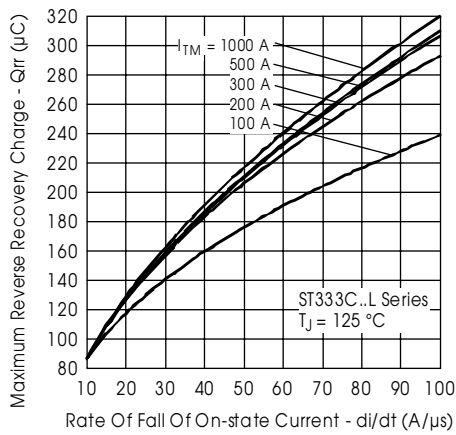

Fig. 11 - Reverse Recovered Charge Characteristics

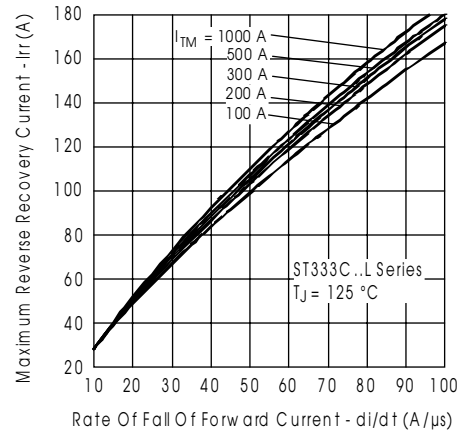

Fig. 12 - Reverse Recovery Current Characteristics

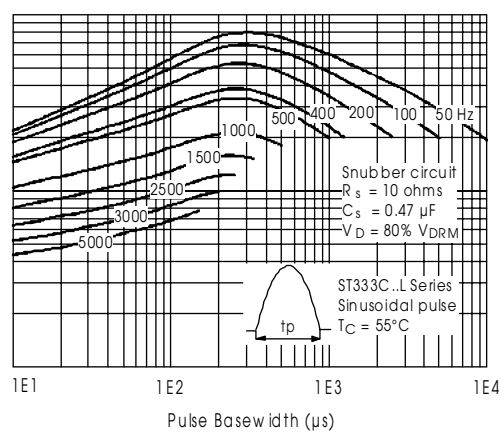
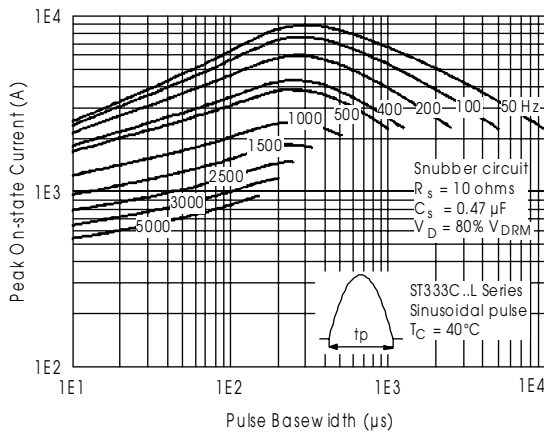

Fig. 13 - Frequency Characteristics

ST333C..L Series

Bulletin I25187 rev. B 04/00

International
IRF Rectifier

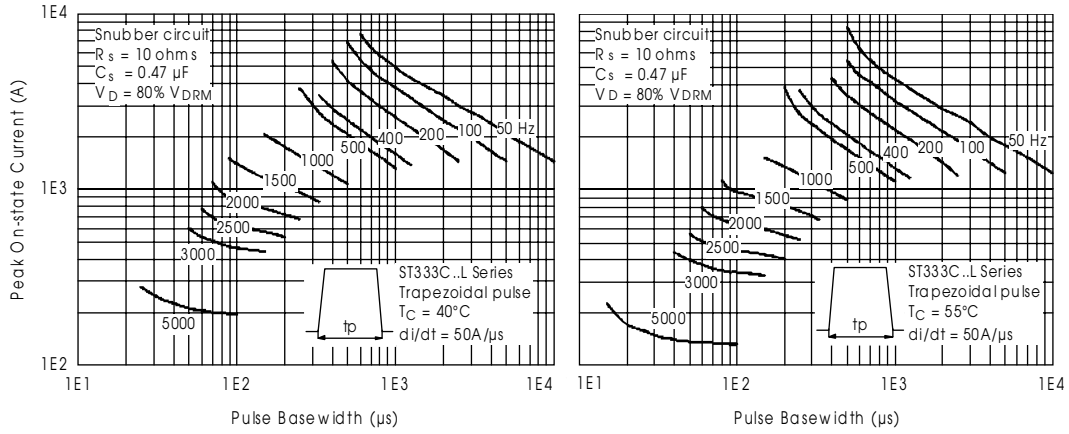

Fig. 14 - Frequency Characteristics

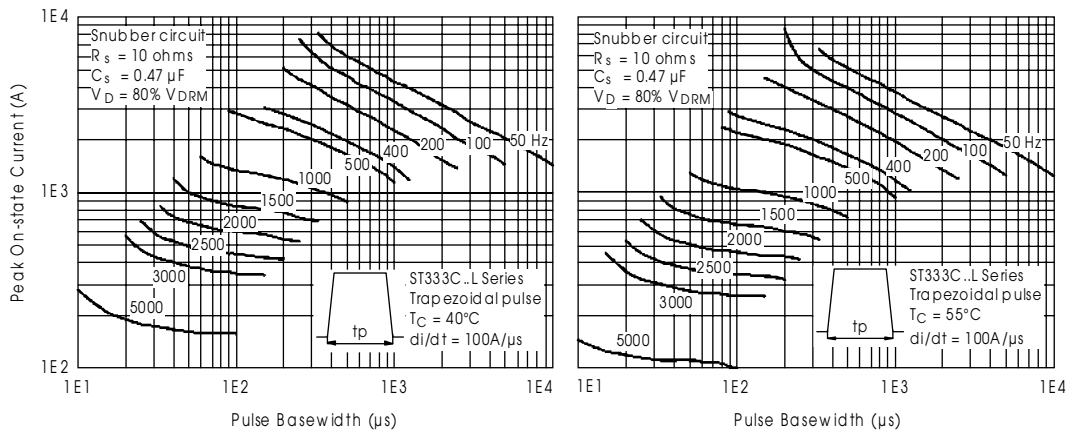

Fig. 15 - Frequency Characteristics

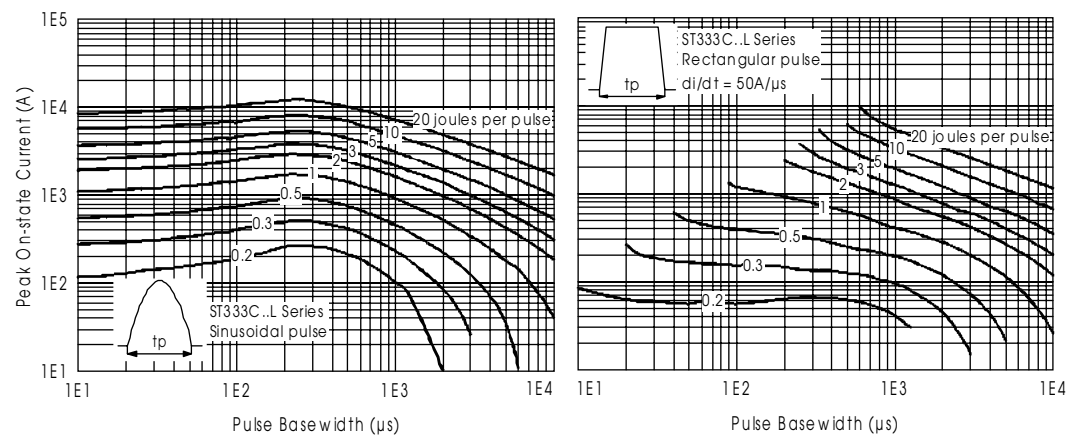

Fig. 16 - Maximum On-state Energy Power Loss Characteristics

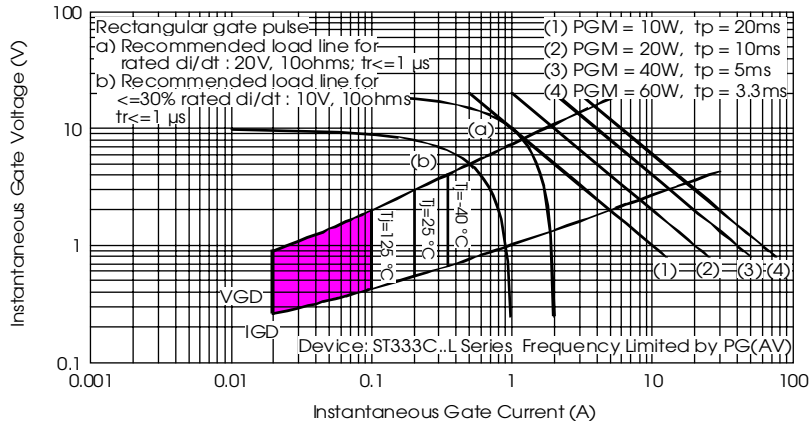

Fig. 17 - Gate Characteristics