

Power Transistor Array STA335A

Absolute Maximum Ratings (Ta=25°C)

Symbol	Ratings	Unit
V _{CB0}	35±5	V
V _{CE0}	35±5	V
V _{EB0}	6	V
I _C	3	A
I _B	1	A
P _T	2.5 (Ta=25°C)	W
	12 (Tc=25°C)	W
T _J	150	°C
T _{stg}	-55 to +150	°C

Electrical Characteristics (Ta=25°C)

Symbol	Test Conditions	Ratings	Unit
I _{CB0}	V _{CB} = 30V	10max	μA
I _{EB0}	V _{EB} = 6V	10max	μA
V _{CE0}	I _C = 25mA	35±5	V
h _{FE}	V _{CE} = 4V, I _C = 0.5A	500min	
V _{CE(sat)}	I _C = 1A, I _B = 5mA	0.5max	V
Es/b	L = 10mH, single pulse	150min	mJ

Typical Switching Characteristics

V _{CC} (V)	R _L (Ω)	I _C (A)	V _{BB1} (V)	V _{BB2} (V)	I _{B1} (mA)	I _{B2} (mA)	t _{on} (μs)	t _{stg} (μs)	t _f (μs)
12	12	1	10	-5	5	5	1.3	4.7	1.2

External Dimensions STA3 (LF400A)

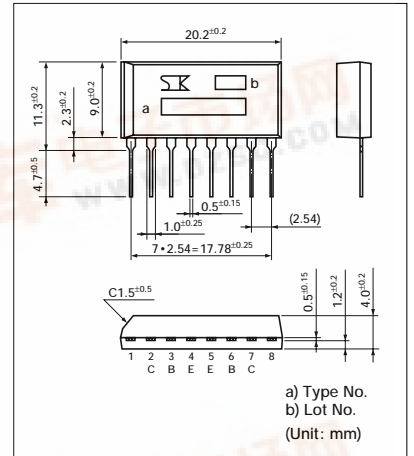

■ I_C — V_{CE} Characteristics (typ.)

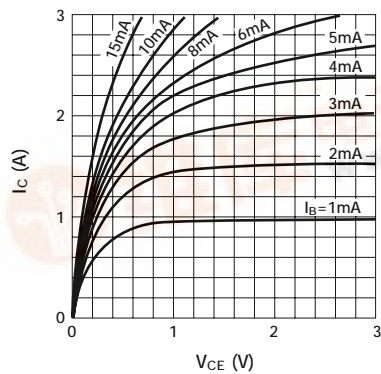

■ V_{CE(sat)} — I_B Temperature Characteristics (I_C = 1A)

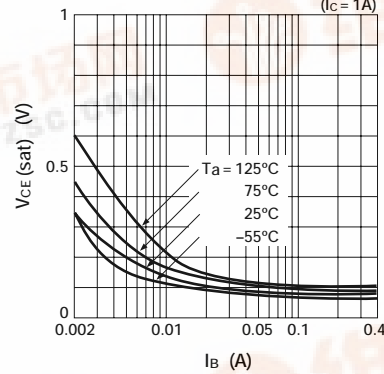

■ I_C — V_{BE} Temperature Characteristics (typ.)

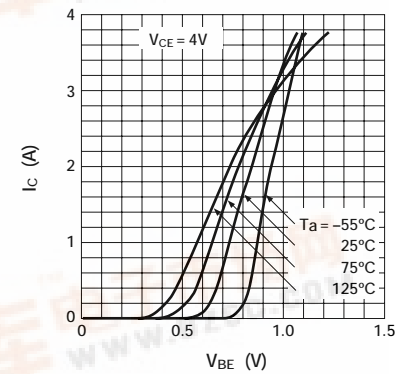

■ h_{FE} — I_C Temperature Characteristics (typ.) (V_{CE} = 4V)

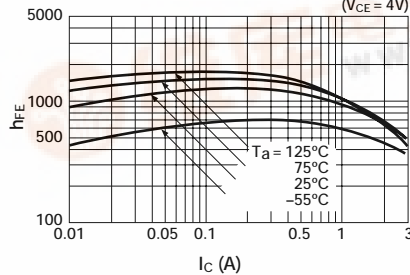

■ t_{on} · t_{stg} · t_f — I_C Characteristics (typ.)

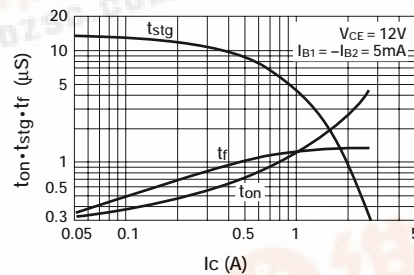

■ θ_{J-a} — t Characteristics

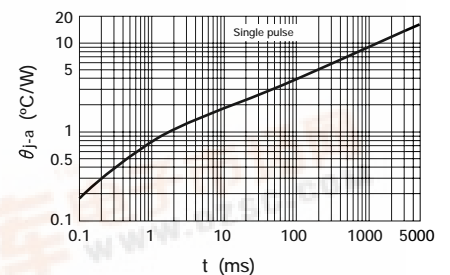

■ Safe Operating Area (single pulse) (per element)

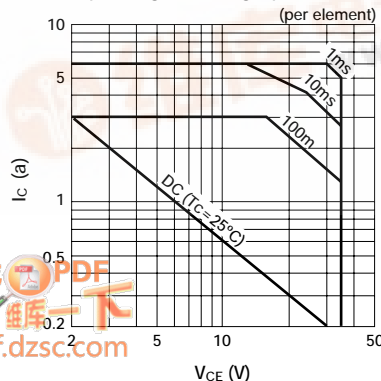

■ P_T — T_a Derating

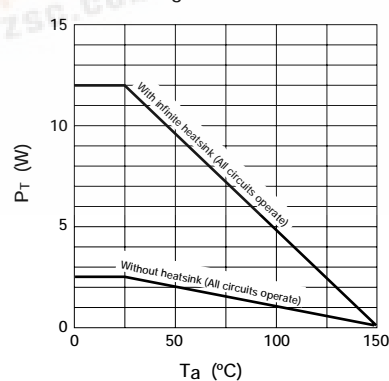

Equivalent Circuit Diagram

