



STGW20NB60HD

N-CHANNEL 20A - 600V TO-247
PowerMESH™ IGBT

TYPE	V _{CES}	V _{CE(sat)}	I _C
STGW20NB60HD	600 V	< 2.8 V	20 A

- HIGH INPUT IMPEDANCE (VOLTAGE DRIVEN)
- LOW ON-VOLTAGE DROP (V_{CESAT})
- LOW GATE CHARGE
- HIGH CURRENT CAPABILITY
- VERY HIGH FREQUENCY OPERATION
- OFF LOSSES INCLUDE TAIL CURRENT
- CO-PACKAGED WITH TURBOSWITCH™ ANTIPARALLEL DIODE

DESCRIPTION

Using the latest high voltage technology based on a patented strip layout, STMicroelectronics has designed an advanced family of IGBTs, the PowerMESH™ IGBTs, with outstanding performances. The suffix "H" identifies a family optimized to achieve very low switching times for high frequency applications (<120kHz).

APPLICATIONS

- HIGH FREQUENCY MOTOR CONTROLS
- WELDING EQUIPMENTS
- SMPS AND PFC IN BOTH HARD SWITCH AND RESONANT TOPOLOGIES

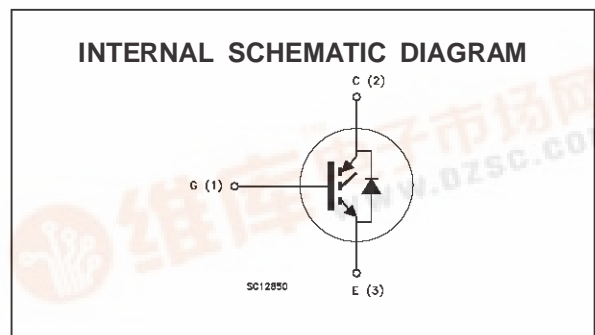
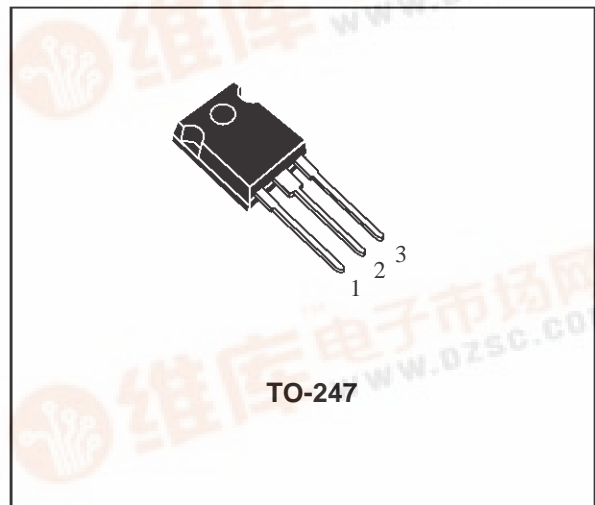

ABSOLUTE MAXIMUM RATINGS

Symbol	Parameter	Value	Unit
V _{CES}	Collector-Emitter Voltage (V _{GS} = 0)	600	V
V _{GE}	Gate-Emitter Voltage	± 20	V
I _C	Collector Current (continuous) at T _c = 25 °C	40	A
I _C	Collector Current (continuous) at T _c = 100 °C	20	A
I _{CM} (•)	Collector Current (pulsed)	160	A
P _{tot}	Total Dissipation at T _c = 25 °C	150	W
	Derating Factor	1.2	W/°C
T _{stg}	Storage Temperature	-65 to 150	°C
T _j	Max. Operating Junction Temperature	150	°C

(•) Pulse width limited by safe operating area

STGW20NB60HD

THERMAL DATA

$R_{thj-case}$	Thermal Resistance Junction-case	Max	0.83	$^{\circ}C/W$
$R_{thj-amb}$	Thermal Resistance Junction-ambient	Max	30	$^{\circ}C/W$
R_{thc-h}	Thermal Resistance Case-heatsink	Typ	0.1	$^{\circ}C/W$

ELECTRICAL CHARACTERISTICS ($T_j = 25^{\circ}C$ unless otherwise specified)

OFF

Symbol	Parameter	Test Conditions	Min.	Typ.	Max.	Unit
$V_{BR(CES)}$	Collector-Emitter Breakdown Voltage	$I_C = 250 \mu A$ $V_{GE} = 0$	600			V
I_{CES}	Collector cut-off ($V_{GE} = 0$)	$V_{CE} = \text{Max Rating}$ $T_j = 25^{\circ}C$ $V_{CE} = \text{Max Rating}$ $T_j = 125^{\circ}C$			250 2000	μA μA
I_{GES}	Gate-Emitter Leakage Current ($V_{CE} = 0$)	$V_{GE} = \pm 20 V$ $V_{CE} = 0$			± 100	nA

ON (*)

Symbol	Parameter	Test Conditions	Min.	Typ.	Max.	Unit
$V_{GE(th)}$	Gate Threshold Voltage	$V_{CE} = V_{GE}$ $I_C = 250 \mu A$	3		5	V
$V_{CE(SAT)}$	Collector-Emitter Saturation Voltage	$V_{GE} = 15 V$ $I_C = 20 A$ $V_{GE} = 15 V$ $I_C = 20 A$ $T_j = 125^{\circ}C$		2.3 1.9	2.8	V V

DYNAMIC

Symbol	Parameter	Test Conditions	Min.	Typ.	Max.	Unit
g_{fs}	Forward Transconductance	$V_{CE} = 25 V$ $I_C = 20 A$	7.0	10		S
C_{ies} C_{oes} C_{res}	Input Capacitance Output Capacitance Reverse Transfer Capacitance	$V_{CE} = 25 V$ $f = 1 MHz$ $V_{GE} = 0$	1200 140 28	1700 200 40	2200 260 52	pF pF pF
Q_G Q_{GE} Q_{GC}	Total Gate Charge Gate-Emitter Charge Gate-Collector Charge	$V_{CE} = 480 V$ $I_C = 20 A$ $V_{GE} = 15 V$		110 13 51	145	nC nC nC
I_{CL}	Latching Current	$V_{clamp} = 480 V$ $R_G = 10 \Omega$ $T_j = 150^{\circ}C$	80			A

SWITCHING ON

Symbol	Parameter	Test Conditions	Min.	Typ.	Max.	Unit
$t_{d(on)}$ t_r	Delay Time Rise Time	$V_{CC} = 480 V$ $I_C = 20 A$ $V_{GE} = 15 V$ $R_G = 10 \Omega$		20 70		ns ns
$(di/dt)_{on}$	Turn-on Current Slope	$V_{CC} = 480 V$ $I_C = 20 A$ $R_G = 10 \Omega$ $V_{GE} = 15 V$		350		A/ μs
$E_{on(\odot)}$	Turn-on Switching Losses	$T_j = 125^{\circ}C$		550		μJ

ELECTRICAL CHARACTERISTICS (continued)

SWITCHING OFF

Symbol	Parameter	Test Conditions	Min.	Typ.	Max.	Unit
t_c	Cross-Over Time	$V_{CC} = 480\text{ V}$		115		ns
$t_r(V_{off})$	Off Voltage Rise Time	$I_C = 20\text{ A}$ $R_{GE} = 10\ \Omega$		32		ns
$t_{d(off)}$	Delay Time	$V_{GE} = 15\text{ V}$		170		ns
t_f	Fall Time			75		ns
$E_{off(**)}$	Turn-off Switching Loss			0.4		mJ
$E_{ts(\circ)}$	Total Switching Loss			0.9		mJ
t_c	Cross-Over Time	$V_{CC} = 480\text{ V}$		190		ns
$t_r(V_{off})$	Off Voltage Rise Time	$I_C = 20\text{ A}$ $R_{GE} = 10\ \Omega$		55		ns
$t_{d(off)}$	Delay Time	$V_{GE} = 15\text{ V}$ $T_j = 125\text{ }^\circ\text{C}$		210		ns
t_f	Fall Time			140		ns
$E_{off(**)}$	Turn-off Switching Loss			0.7		mJ
$E_{ts(\circ)}$	Total Switching Loss			1.25		mJ

COLLECTOR-EMITTER DIODE

Symbol	Parameter	Test Conditions	Min.	Typ.	Max.	Unit
I_f	Forward Current				20	A
I_{fm}	Forward Current pulsed				160	A
V_f	Forward On-Voltage	$I_f = 20\text{ A}$ $I_f = 20\text{ A}$		1.50	2.0	V
		$T_j = 125\text{ }^\circ\text{C}$		1.25		V
t_{rr}	Reverse Recovery Time	$I_f = 20\text{ A}$		100		nS
Q_{rr}	Reverse Recovery Charge	$dI/dt = 100\text{ A}/\mu\text{S}$		300		nC
I_{rrm}	Reverse Recovery Current	$V_R = 200\text{ V}$ $T_j = 125\text{ }^\circ\text{C}$		5.9		A

- (●) Pulse width limited by max. junction temperature
- (○) Include recovery losses on the STTA2006 freewheeling diode
- (*) Pulsed: Pulse duration = 300 μs , duty cycle 1.5 %
- (**) Losses Include Also The Tail (Jedec Standardization)

Thermal Impedance

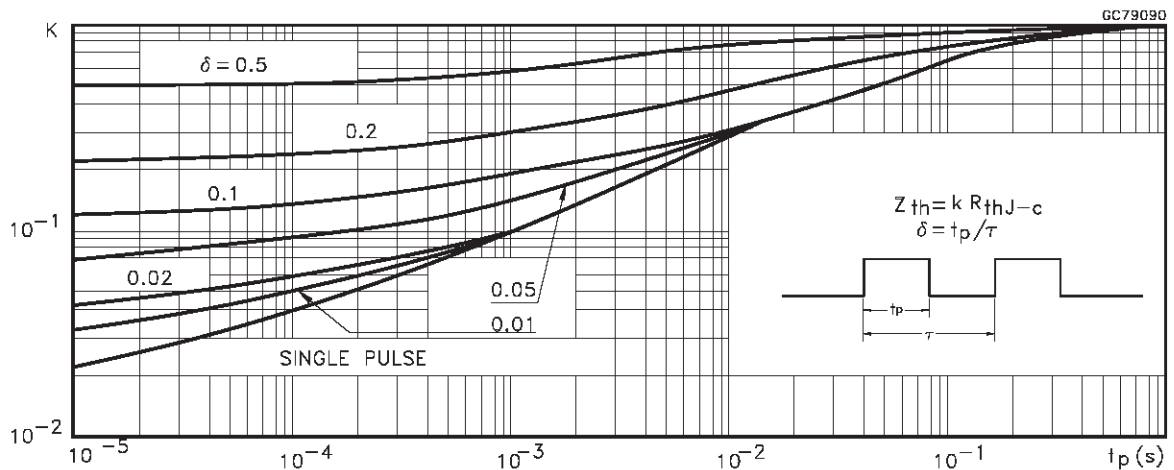

STGW20NB60HD

Output Characteristics

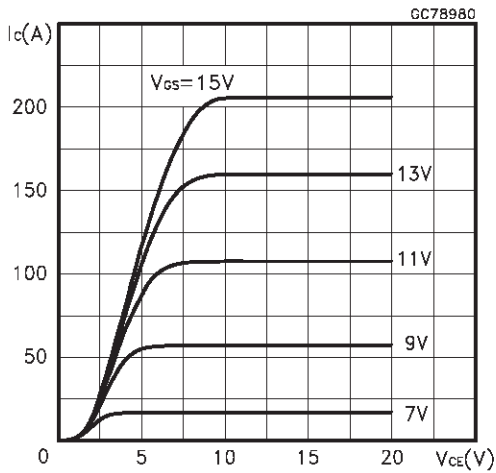

Transfer Characteristics

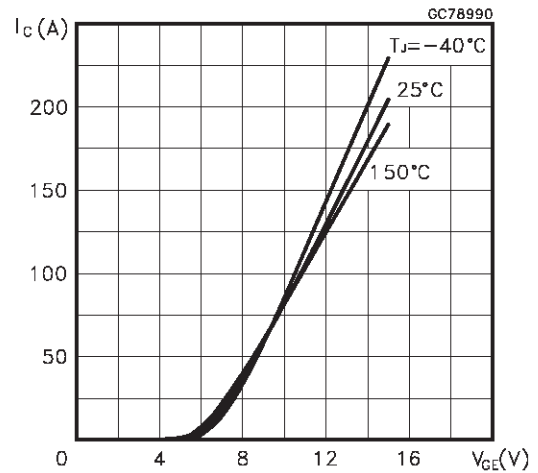

Transconductance

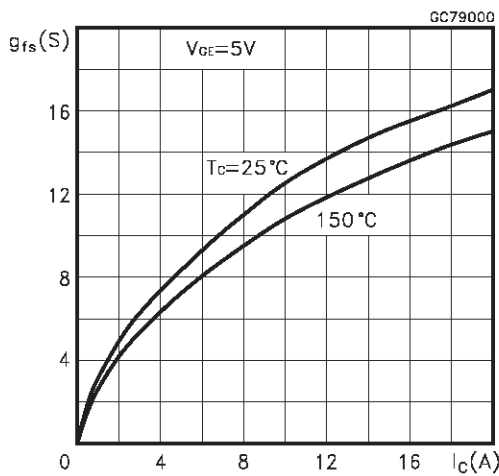

Collector-Emitter On Voltage vs Temperature

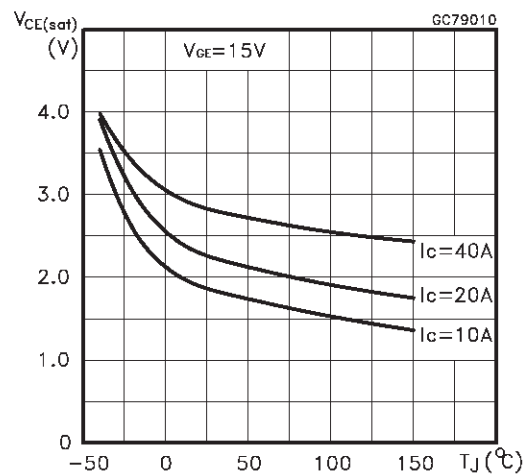

Collector-Emitter On Voltage vs Collector Current

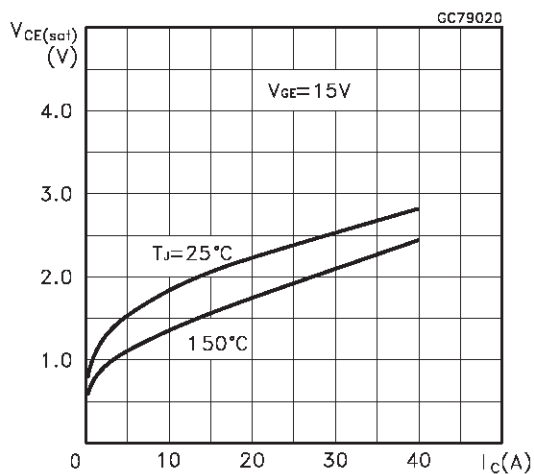

Gate Threshold vs Temperature

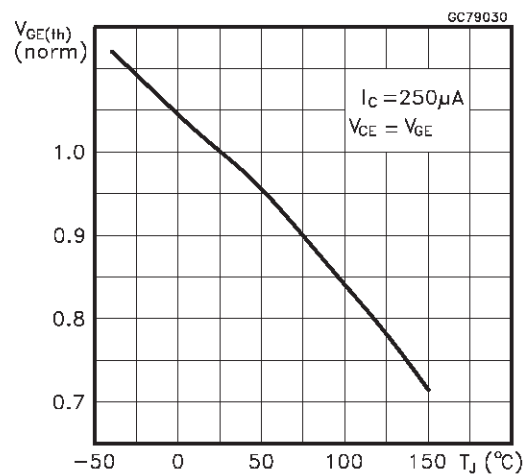

Normalized Breakdown Voltage vs Temperature

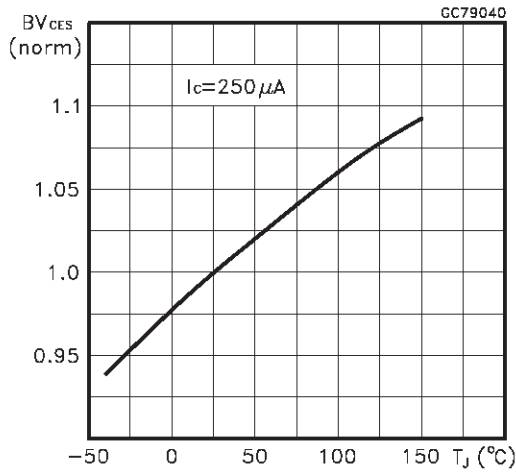

Capacitance Variations

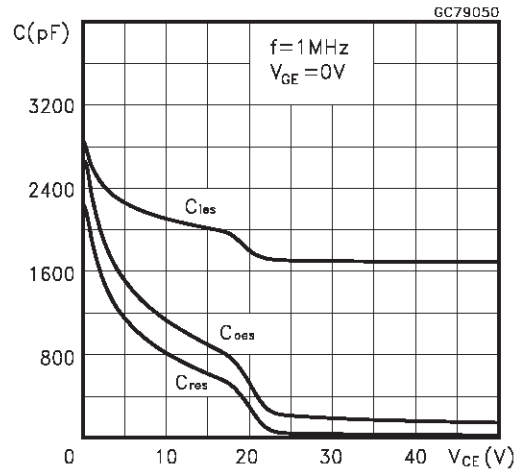

Gate Charge vs Gate-Emitter Voltage

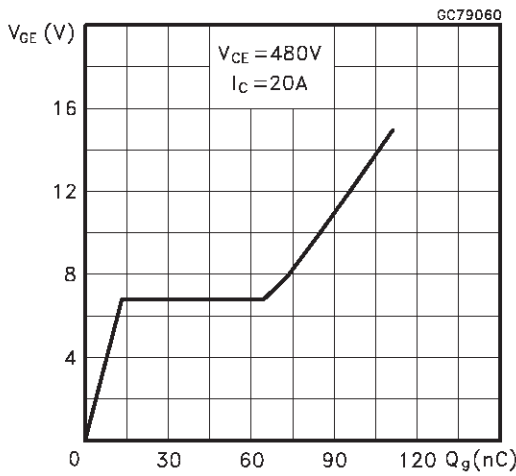

Total Switching Losses vs Gate Resistance

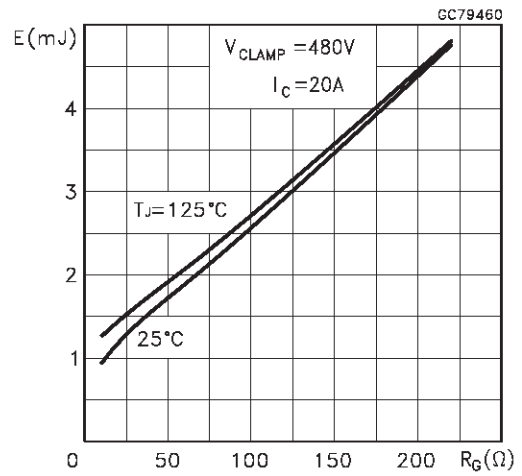

Total Switching Losses vs Temperature

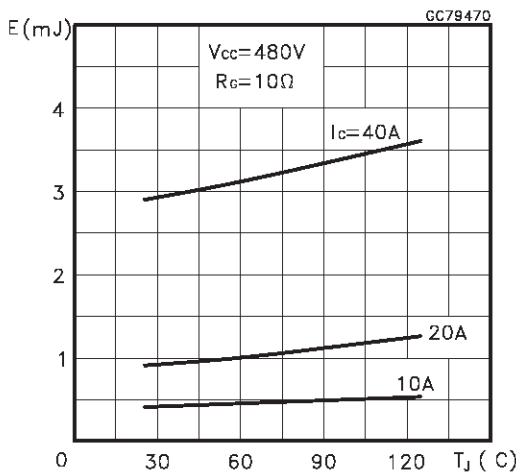

Total Switching Losses vs Collector Current

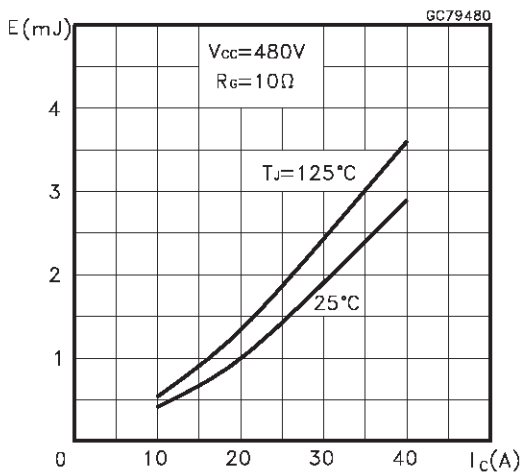

STGW20NB60HD

Switching Off Safe Operating Area

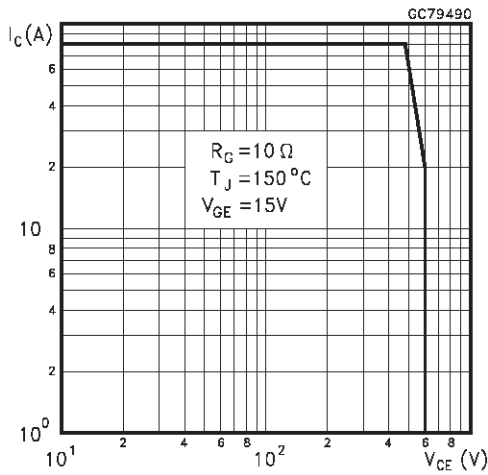

Fig. 1: Gate Charge test Circuit

Diode Forward Voltage

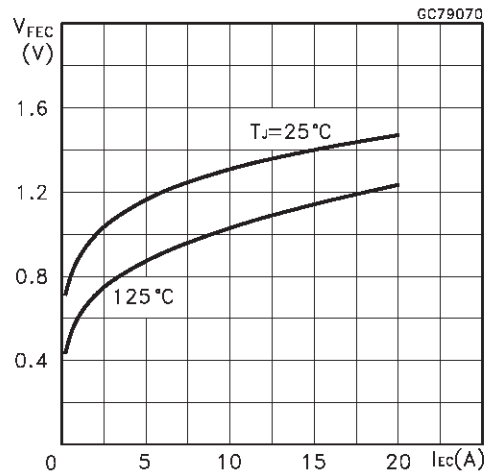

Fig. 2: Test Circuit For Inductive Load Switching

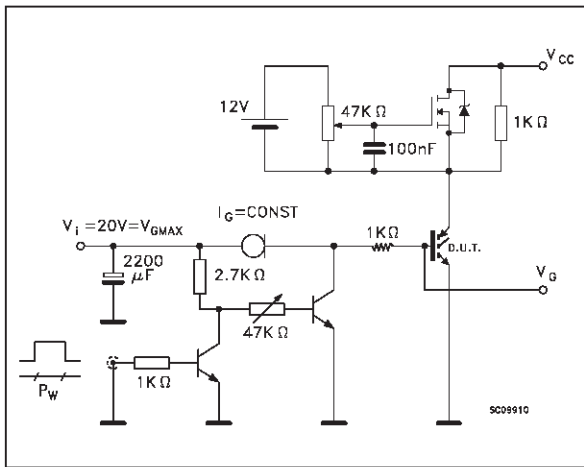
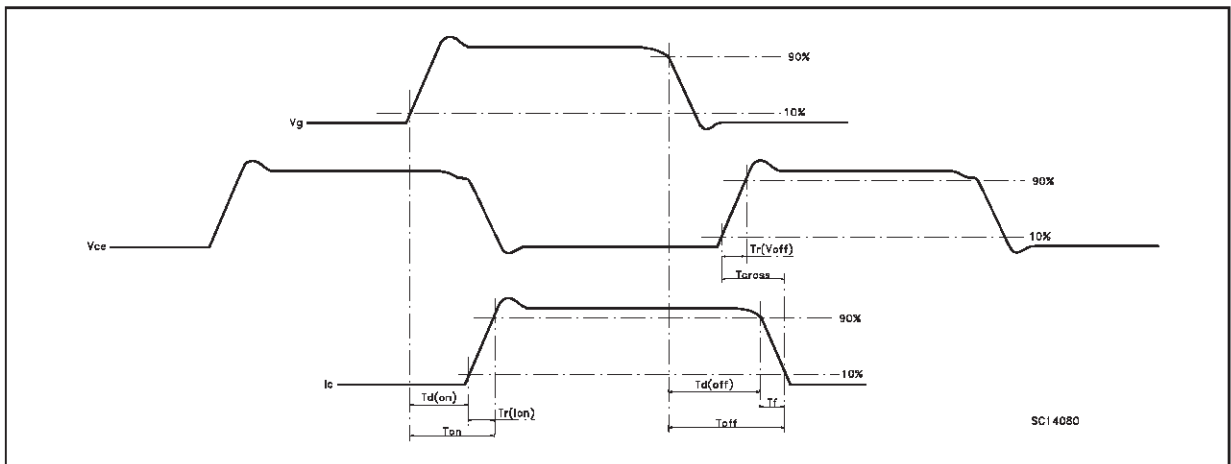
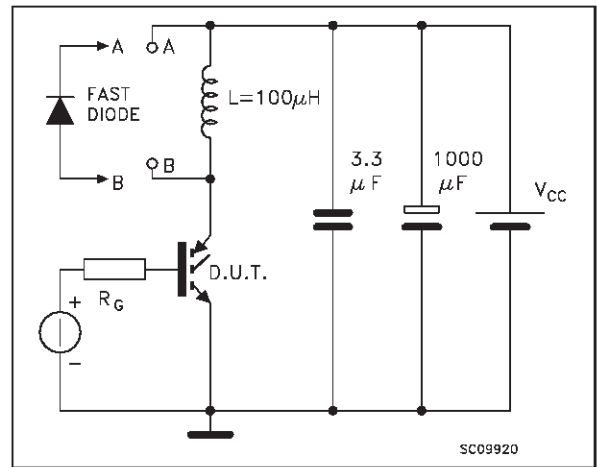
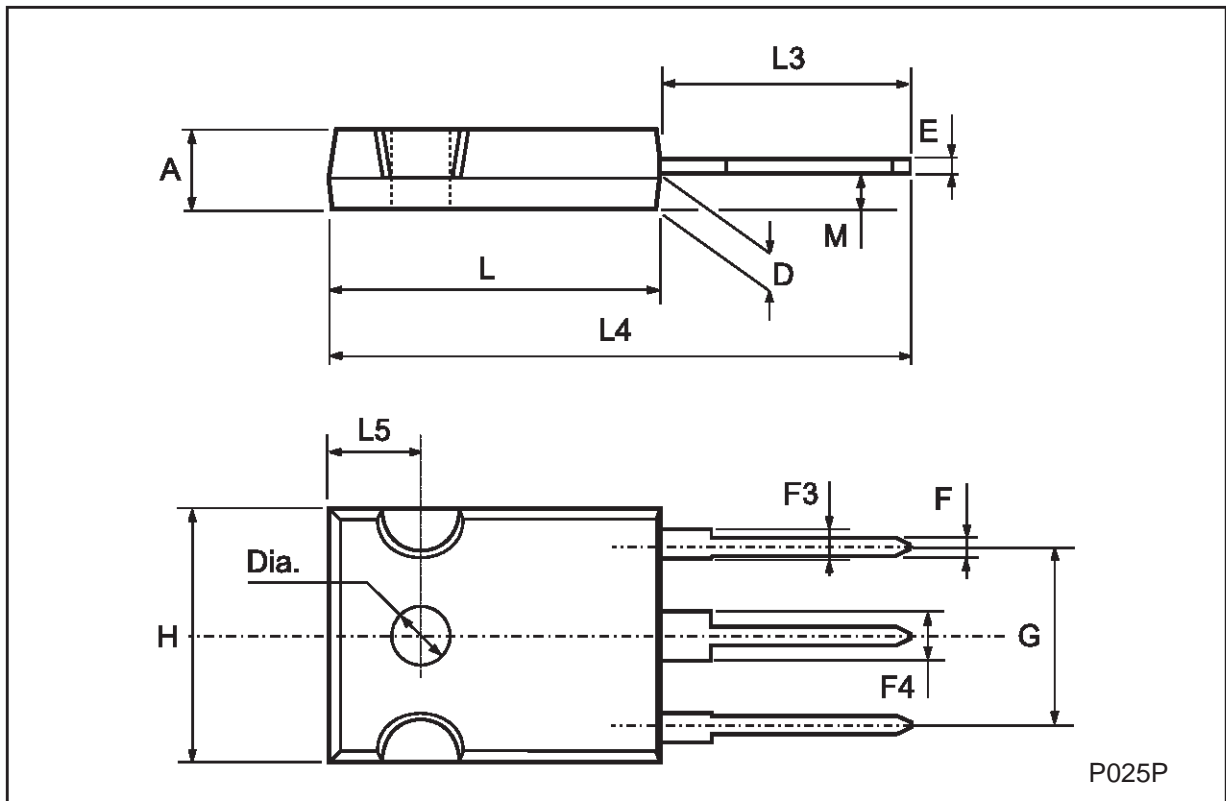

Fig. 3: Switching Waveforms



TO-247 MECHANICAL DATA

DIM.	mm			inch		
	MIN.	TYP.	MAX.	MIN.	TYP.	MAX.
A	4.7		5.3	0.185		0.209
D	2.2		2.6	0.087		0.102
E	0.4		0.8	0.016		0.031
F	1		1.4	0.039		0.055
F3	2		2.4	0.079		0.094
F4	3		3.4	0.118		0.134
G		10.9			0.429	
H	15.3		15.9	0.602		0.626
L	19.7		20.3	0.776		0.779
L3	14.2		14.8	0.559		0.582
L4		34.6			1.362	
L5		5.5			0.217	
M	2		3	0.079		0.118



Information furnished is believed to be accurate and reliable. However, STMicroelectronics assumes no responsibility for the consequences of use of such information nor for any infringement of patents or other rights of third parties which may result from its use. No license is granted by implication or otherwise under any patent or patent rights of STMicroelectronics. Specification mentioned in this publication are subject to change without notice. This publication supersedes and replaces all information previously supplied. STMicroelectronics products are not authorized for use as critical components in life support devices or systems without express written approval of STMicroelectronics.

The ST logo is a trademark of STMicroelectronics

© 1999 STMicroelectronics – Printed in Italy – All Rights Reserved
STMicroelectronics GROUP OF COMPANIES

Australia - Brazil - China - Finland - France - Germany - Hong Kong - India - Italy - Japan - Malaysia - Malta - Morocco -
Singapore - Spain - Sweden - Switzerland - United Kingdom - U.S.A.