



STSA1805

LOW VOLTAGE FAST-SWITCHING NPN POWER TRANSISTOR

PRELIMINARY DATA

Ordering Code	Marking	Package / Shipment
STSA1805	SA1805	TO-92 / Bulk
STSA1805-AP	SA1805	TO-92 / Ammopack

- VERY LOW COLLECTOR TO EMITTER SATURATION VOLTAGE
- HIGH CURRENT GAIN CHARACTERISTIC
- FAST-SWITCHING SPEED

APPLICATIONS:

- EMERGENCY LIGHTING
- VOLTAGE REGULATORS
- RELAY DRIVERS
- HIGH EFFICIENCY LOW VOLTAGE SWITCHING APPLICATIONS

DESCRIPTION

The device is manufactured in NPN Planar Technology by using a "Base Island" layout. The resulting Transistor shows exceptional high gain performance coupled with very low saturation voltage.

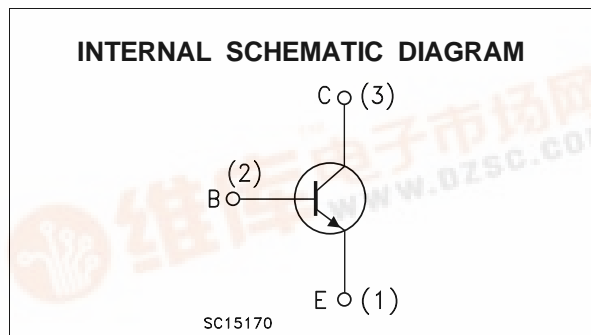
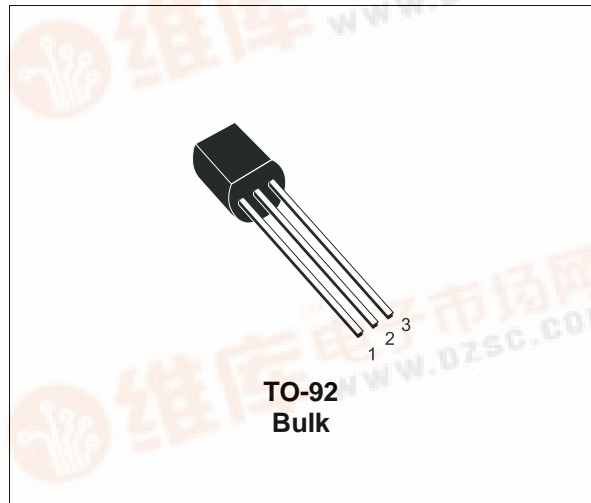

ABSOLUTE MAXIMUM RATINGS

Symbol	Parameter	Value	Unit
V_{CBO}	Collector-Base Voltage ($I_E = 0$)	150	V
V_{CEO}	Collector-Emitter Voltage ($I_B = 0$)	60	V
V_{EBO}	Emitter-Base Voltage ($I_C = 0$)	7	V
I_C	Collector Current	5	A
I_{CM}	Collector Peak Current ($t_p < 5$ ms)	15	A
I_B	Base Current	2	A
P_{tot}	Total Dissipation at $T_{amb} = 25$ °C	1.1	W
T_{stg}	Storage Temperature	-65 to 150	°C
T_j	Max. Operating Junction Temperature	150	°C

STSA1805

THERMAL DATA

R _{thj-amb}	Thermal Resistance Junction-Ambient	Max	114	°C/W
R _{thj-case}	Thermal Resistance Junction-case	Max	83.3	°C/W

ELECTRICAL CHARACTERISTICS (T_{case} = 25 °C unless otherwise specified)

Symbol	Parameter	Test Conditions		Min.	Typ.	Max.	Unit
I _{CBO}	Collector Cut-off Current (I _E = 0)	V _{CB} = 40 V				0.1	μA
I _{EBO}	Emitter Cut-off Current (I _C = 0)	V _{EB} = 4 V				0.1	μA
V _{(BR)CBO}	Collector-Base Breakdown Voltage (I _E = 0)	I _C = 100 μA		150			V
V _{(BR)CEO*}	Collector-Emitter Breakdown Voltage (I _B = 0)	I _C = 1 mA		60			V
V _{(BR)EBO}	Emitter-Base Breakdown Voltage (I _C = 0)	I _E = 100 μA		7			V
V _{CE(sat)*}	Collector-Emitter Saturation Voltage	I _C = 100 mA I _C = 2 A I _C = 3 A I _C = 5 A	I _B = 5 mA I _B = 50 mA I _B = 150 mA I _B = 200 mA		150 200	50 300 400 600	mV mV mV mV
V _{BE(sat)*}	Base-Emitter Saturation Voltage	I _C = 2 A	I _B = 100 mA		0.9	1.2	V
h _{FE*}	DC Current Gain	I _C = 100 mA I _C = 5 A I _C = 10 A	V _{CE} = 2 V V _{CE} = 2 V V _{CE} = 2 V	200 85 20		400	
f _T	Transition frequency	V _{CE} = 10 V	I _C = 50 mA		150		MHz
C _{CBO}	Collector-Base Capacitance	V _{CB} = 10 V	f = 1 MHz		50		pF
t _{on} t _s t _f	RESISTIVE LOAD Turn- on Time Storage Time Fall Time	I _C = 1 A I _{B1} = - I _{B2} = 0.1 A	V _{CC} = 30 V		50 1.35 120		ns μs ns

* Pulsed: Pulse duration = 300μs, duty cycle = 1.5 %

Derating Curve

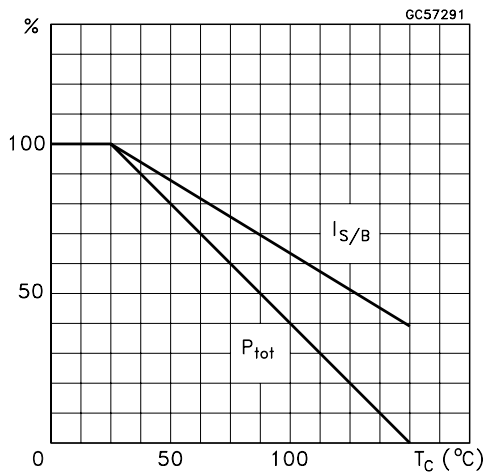

DC Current Gain

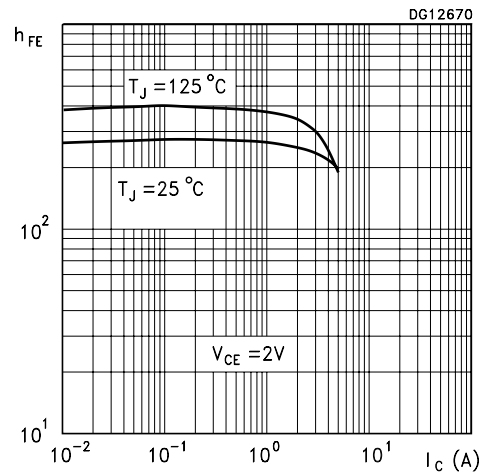

Collector-Emitter Saturation Voltage

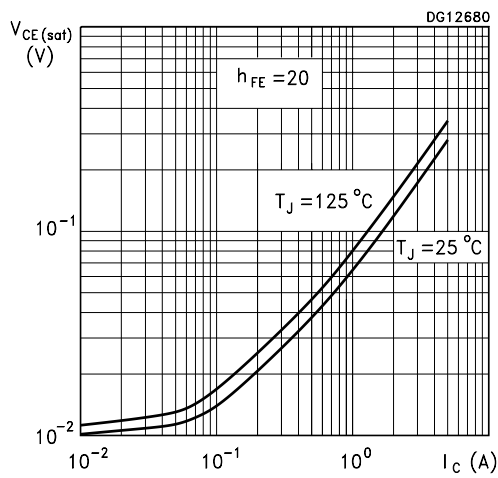

Collector-Emitter Saturation Voltage

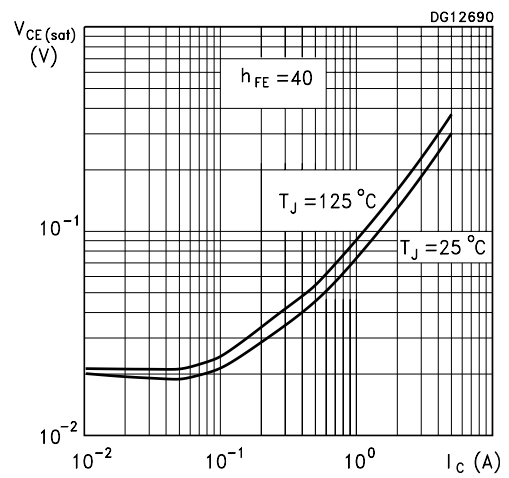

Base-Emitter Saturation Voltage

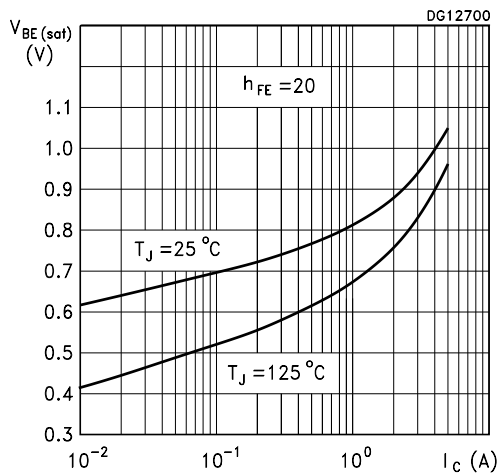

Base-Emitter On Voltage

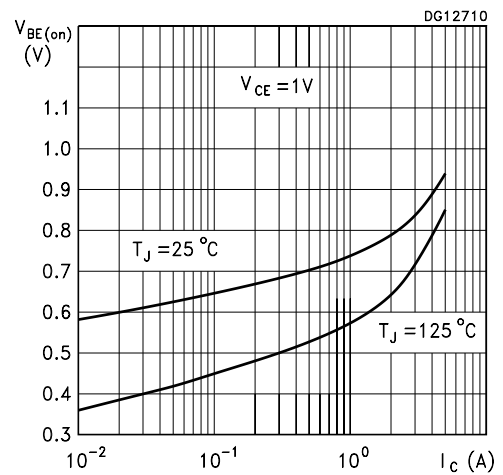

Switching Times Resistive Load

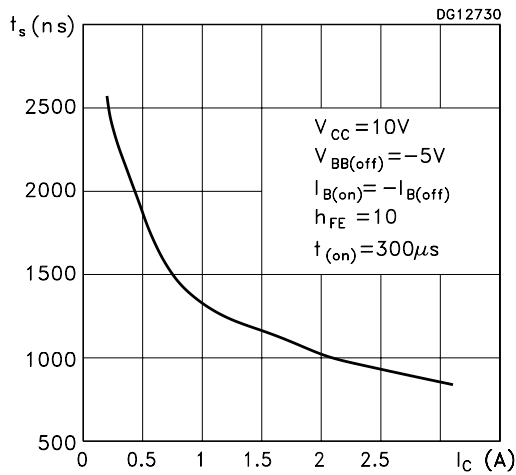

Switching Times Resistive Load

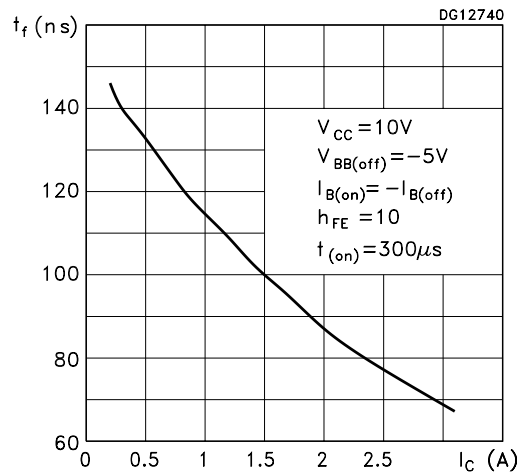

Switching Times Resistive Load

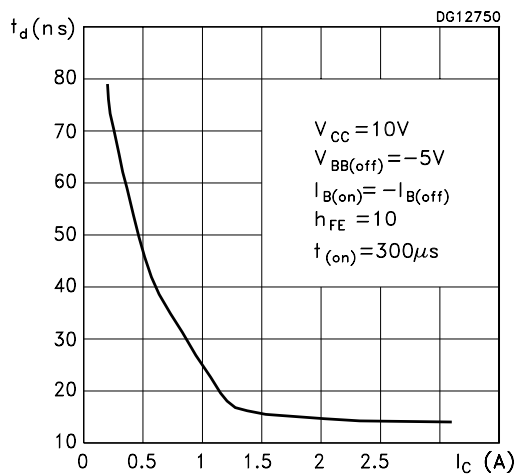

Switching Times Inductive Load

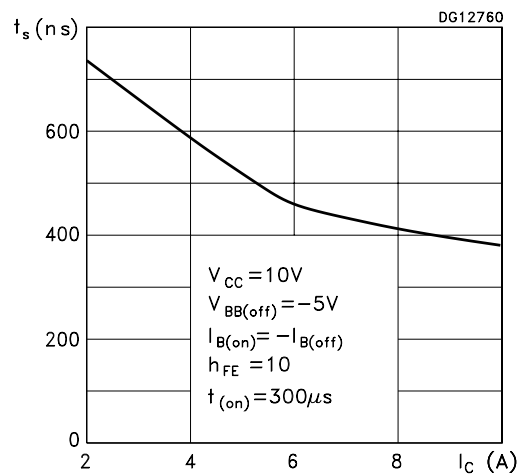

Switching Times Inductive Load

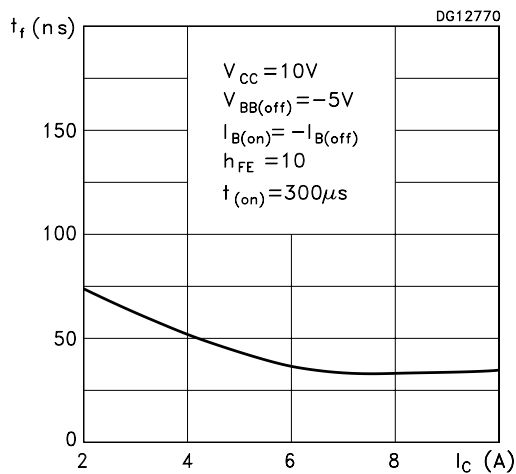
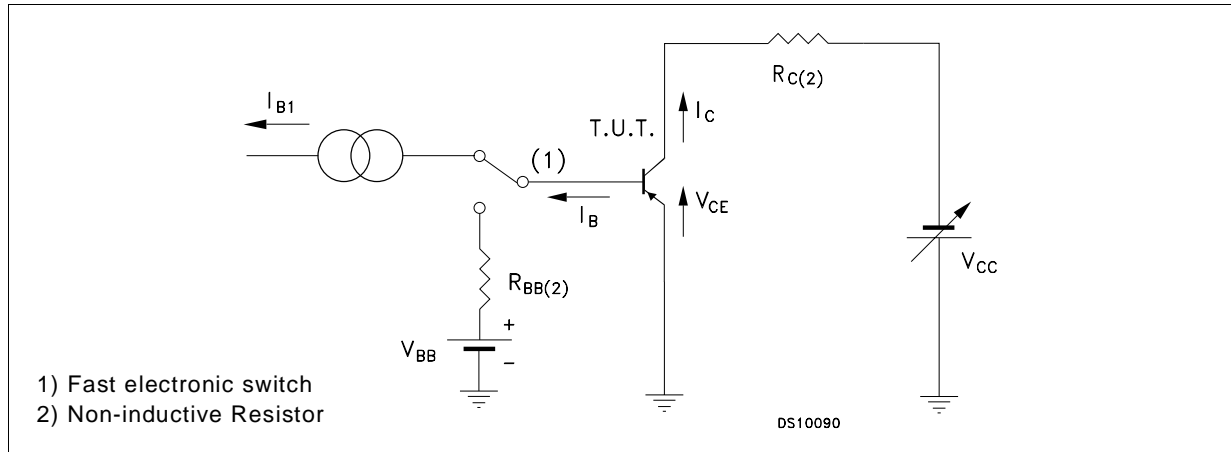
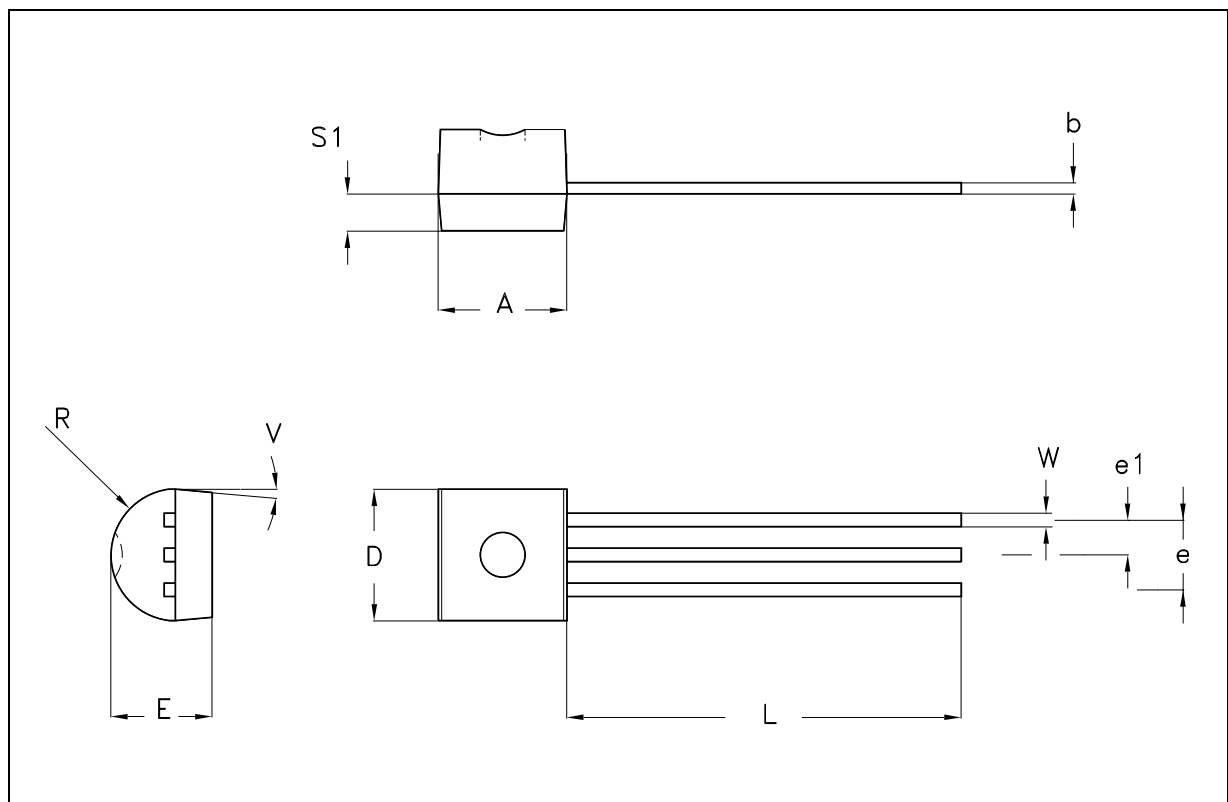

Figure 1: Resistive Load Switching Test Circuit.

TO-92 MECHANICAL DATA

DIM.	mm			inch		
	MIN.	TYP.	MAX.	MIN.	TYP.	MAX.
A	4.32		4.95	0.170		0.195
b	0.36		0.51	0.014		0.020
D	4.45		4.95	0.175		0.194
E	3.30		3.94	0.130		0.155
e	2.41		2.67	0.095		0.105
e1	1.14		1.40	0.045		0.055
L	12.70		15.49	0.500		0.609
R	2.16		2.41	0.085		0.094
S1	1.14		1.52	0.045		0.059
W	0.41		0.56	0.016		0.022
V	4 degree		6 degree	4 degree		6 degree



TO-92 AMMOPACK SHIPMENT (Suffix"-AP") MECHANICAL DATA

DIM.	mm			inch		
	MIN.	TYP.	MAX.	MIN.	TYP.	MAX.
A1			4.80			0.189
T			3.80			0.150
T1			1.60			0.063
T2			2.30			0.091
d			0.48			0.019
P0	12.50	12.70	12.90	0.492	0.500	0.508
P2	5.65	6.35	7.05	0.222	0.250	0.278
F1,F2	2.44	2.54	2.94	0.096	0.100	0.116
delta H	-2.00		2.00	-0.079		0.079
W	17.50	18.00	19.00	0.689	0.709	0.748
W0	5.70	6.00	6.30	0.224	0.236	0.248
W1	8.50	9.00	9.25	0.335	0.354	0.364
W2			0.50			0.020
H	18.50		20.50	0.728		0.807
H0	15.50	16.00	16.50	0.610	0.630	0.650
H1			25.00			0.984
D0	3.80	4.00	4.20	0.150	0.157	0.165
t			0.90			0.035
L			11.00			0.433
l1	3.00			0.118		
delta P	-1.00		1.00	-0.039		0.039

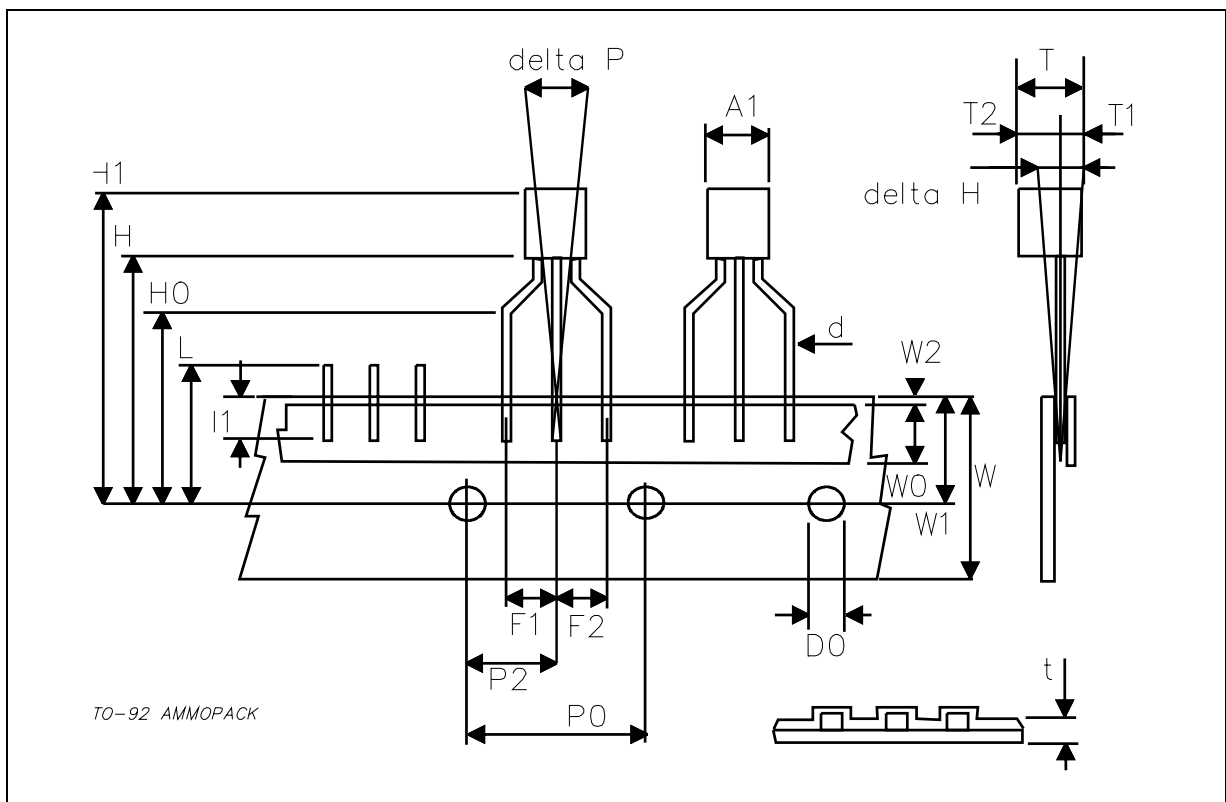

Information furnished is believed to be accurate and reliable. However, STMicroelectronics assumes no responsibility for the consequences of use of such information nor for any infringement of patents or other rights of third parties which may result from its use. No license is granted by implication or otherwise under any patent or patent rights of STMicroelectronics. Specification mentioned in this publication are subject to change without notice. This publication supersedes and replaces all information previously supplied. STMicroelectronics products are not authorized for use as critical components in life support devices or systems without express written approval of STMicroelectronics.

The ST logo is a trademark of STMicroelectronics.

All other names are the property of their respective owners.

© 2003 STMicroelectronics – All Rights reserved

STMicroelectronics GROUP OF COMPANIES

Australia - Belgium - Brazil - Canada - China - Czech Republic - Finland - France - Germany - Hong Kong - India - Israel - Italy - Japan - Malaysia - Malta - Morocco - Singapore - Spain - Sweden - Switzerland - United Kingdom - United States.

<http://www.st.com>